

COMPREHENSIVE SERVICES

We offer competitive repair and calibration services, as well as easily accessible documentation and free downloadable resources.

SELL YOUR SURPLUS

We buy new, used, decommissioned, and surplus parts from every NI series. We work out the best solution to suit your individual needs.

 Sell For Cash  Get Credit  Receive a Trade-In Deal

OBSOLETE NI HARDWARE IN STOCK & READY TO SHIP

We stock **New**, **New Surplus**, **Refurbished**, and **Reconditioned** NI Hardware.



Bridging the gap between the manufacturer and your legacy test system.

 1-800-915-6216

 www.apexwaves.com

 sales@apexwaves.com

All trademarks, brands, and brand names are the property of their respective owners.

Request a Quote

 **CLICK HERE**

SCC-AI07

USER GUIDE

SCC-AI Series Isolated Analog Input Modules

The SCC-AI Series isolated analog input modules can extract a relatively low-amplitude input signal from a high-common-mode voltage so the E/M Series DAQ device can measure the input signal. They also can amplify and filter the input signal, resulting in higher measurement resolution and accuracy.

SCC-AI Series modules are available in a range of gains from 0.2 to 200. They contain lowpass filters of either 10 kHz or 4 Hz bandwidth. Table 1 gives the gain and bandwidth for each module.

Table 1. SCC-AI Module Input/Output Range, Gain, and Bandwidth

Model	Input Range	Output Range	Gain	Bandwidth
SCC-AI01	$\pm 42 V_{pk}/VDC$	$\pm 8.4 V$	0.2	10 kHz
SCC-AI02	$\pm 20 V$	$\pm 10 V$	0.5	10 kHz
SCC-AI03	$\pm 10 V$	$\pm 10 V$	1	10 kHz
SCC-AI04	$\pm 5 V$	$\pm 10 V$	2	10 kHz
SCC-AI05	$\pm 1 V$	$\pm 10 V$	10	10 kHz
SCC-AI06	$\pm 100 mV$	$\pm 10 V$	100	10 kHz
SCC-AI07	$\pm 50 mV$	$\pm 10 V$	200	10 kHz
SCC-AI13	$\pm 10 V$	$\pm 10 V$	1	4 Hz
SCC-AI14	$\pm 5 V$	$\pm 10 V$	2	4 Hz

Conventions

The following conventions are used in this guide:

<>

Angle brackets that contain numbers separated by an ellipsis represent a range of values associated with a bit or signal name—for example, AI <0..7>.

»

The » symbol leads you through nested menu items and dialog box options to a final action. The sequence **File»Page Setup»Options** directs you to pull down the **File** menu, select the **Page Setup** item, and select **Options** from the last dialog box.



This icon denotes a note, which alerts you to important information.



This icon denotes a caution, which advises you of precautions to take to avoid injury, data loss, or a system crash. When this symbol is marked on the product, refer to the *Read Me First: Safety and Radio-Frequency Interference* document, shipped with the product, for precautions to take.



When symbol is marked on a product, it denotes a warning advising you to take precautions to avoid electrical shock.



When symbol is marked on a product, it denotes a component that may be hot. Touching this component may result in bodily injury.

bold

Bold text denotes items that you must select in the software, such as menu items and dialog box options. Bold text also denotes parameter names.

italic

Italic text denotes variables, emphasis, a cross-reference, or an introduction to a key concept. Italic text also denotes text that is a placeholder for a word or value that you must supply.

monospace

Text in this font denotes text or characters that you should enter from the keyboard, sections of code, programming examples, and syntax examples. This font is also used for the proper names of disk drives, paths, directories, programs, subprograms, subroutines, device names, functions, operations, variables, filenames, and extensions.

SC-2345

SC-2345 refers to both the SC-2345 connector block and the SC-2345 configurable connector.

SCC

SCC refers to any SCC series signal conditioning module.

SCC-AI

SCC-AI refers to any isolated analog input module in the SCC-AI Series unless otherwise noted.

What You Need to Get Started

To set up and use the SCC-AI, you need the following items:

- Hardware
 - SCC-68
 - or
 - SC-2345/2350 with one of the following:
 - SCC-PWR01
 - SCC-PWR02 and the PS01 power supply
 - SCC-PWR03 (requires a 7 to 42 VDC power supply, not included)
 - One or more SCC-AI
 - 68-pin E/M Series DAQ device
 - 68-pin cable
 - Quick Reference Label
- Software
 - The latest version of NI-DAQmx
- Documentation
 - *SCC-AI Series Isolated Analog Input Modules User Guide*
 - *SC-2345/2350 User Manual*
 - *SCC-68 User Guide*
 - or
 - *SCC Quick Start Guide*
 - *Read Me First: Safety and Radio-Frequency Interference*
 - Documentation for your hardware
 - Documentation for your software
- Tools
 - 1/8 in. flathead screwdriver
 - Numbers 1 and 2 Phillips screwdrivers
 - Wire insulation stripper



Note Software scaling of measurements is not supported on the Macintosh operating system. Refer to the [SCC-AI Module Pin Assignments](#) section.

You can download NI documents from ni.com/manuals. To download the latest version of NI-DAQmx, click **Download Software** at ni.com.

Device Specific Information



Note For general SCC module installation and signal connection information, and information about the SC-2345/2350 or SCC-68, refer to the *SCC Quick Start Guide*, available for download at ni.com/manuals.

Installing the Module



Caution Refer to the *Read Me First: Safety and Radio-Frequency Interference* document before removing equipment covers or connecting/disconnecting any signal wires.

You can plug the SCC-AI into any analog input socket on the SC-2345/2350 or SCC-68. The socket you choose determines which E/M Series DAQ device channels receive the SCC-AI signals.

For single-stage input conditioning, plug the SCC-AI into any slot of the SC-68, or any socket of the SC-2345/2350 J(X+1), where X is 0 to 7. Connect the input signals to the module as described in the [Connecting the Input Signals](#) section.

If you use the SCC-AI in a dual-stage configuration in an SC-2345, the SCC-AI must be the first-stage module. Plug it into any socket J(X+9) and plug the second-stage SCC into socket J(X+1), where X is 0 to 7. Connect the input signals to the SCC-AI as described in the [Connecting the Input Signals](#) section. The SC-2345 connects the output signals of the first-stage SCC to the inputs of the second-stage SCC. An example of dual-stage conditioning is an SCC-AI02 followed by an SCC-FV01 frequency input module.

Sockets J9 to J16 of the SC-2345 are also available for digital input/output (DIO) conditioning or control. Refer to the *SC-2345/2350 User Manual* for more information about configuring, connecting, and installing SCC modules.

Connecting the Input Signals



Note The signal names have changed. Refer to ni.com/info and enter `rdntng` to confirm the signal names.

Each screw terminal on the SCC-AI is labeled by pin number <1..4>. Pins 1 and 2 form a channel routed to E/M Series DAQ device channel X+8, and pins 3 and 4 form a channel routed to the E/M Series DAQ device channel X, where X is 0 to 7 depending on the socket where you plug in the module. The SCC-AI provides channel-to-ground and module-to-module isolation only. It does not provide isolation between the two channels of the SCC-AI. Because both channels must have the same reference voltage, pins 1 and 3 are connected together internally.

Figure 1 shows the SCC-AI signal connections.

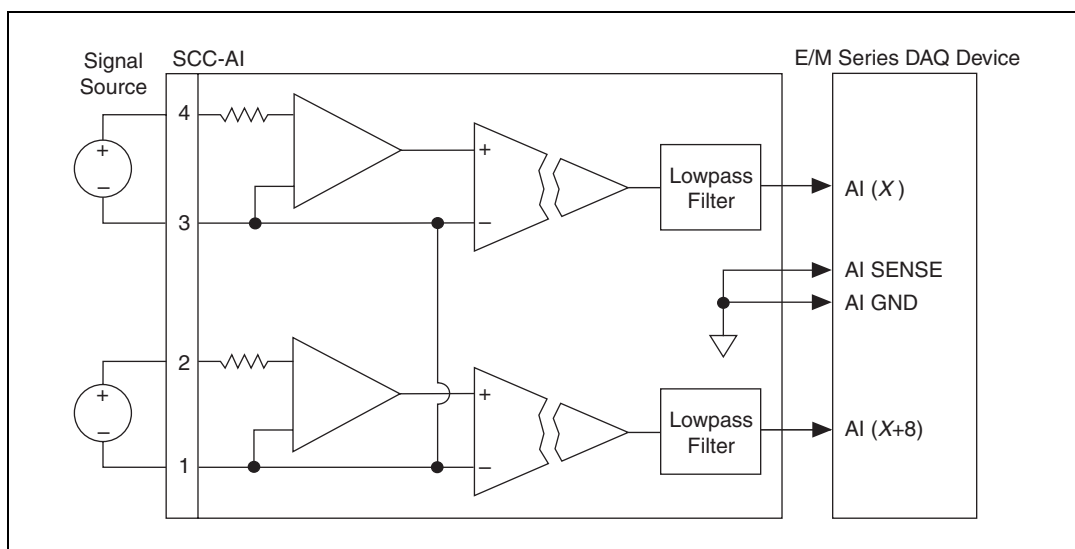

Figure 1. SCC-AI Signal Connections

The inputs are designed in a floating (nonreferenced) single-ended configuration. If the measured signals are floating, connect the negative input pins, 1 and 3, to AI SENSE on the SC-2345/2350 terminal block or AI GND on the SC-68, through a 10 k Ω to 100 k Ω resistor. Figure 2 shows a floating signal connection on one channel of the SCC-AI.

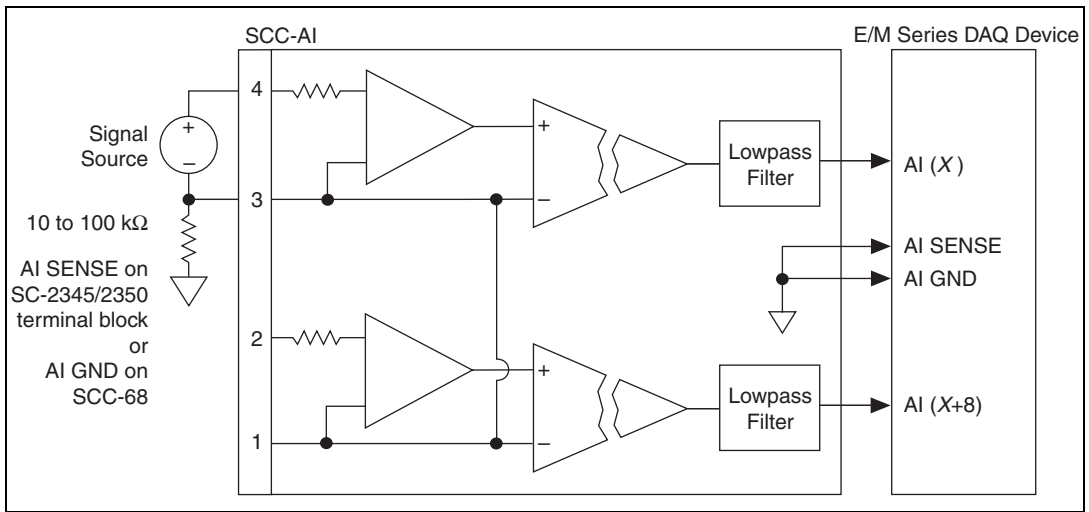

Figure 2. Nonreferenced Signal Connection for the SCC-AI (One Channel)

If a high common-mode voltage is present, connect the negative input pins, 1 and 3, to the signal reference. Figure 3 shows a ground-referenced signal connection on one channel of the SCC-AI.

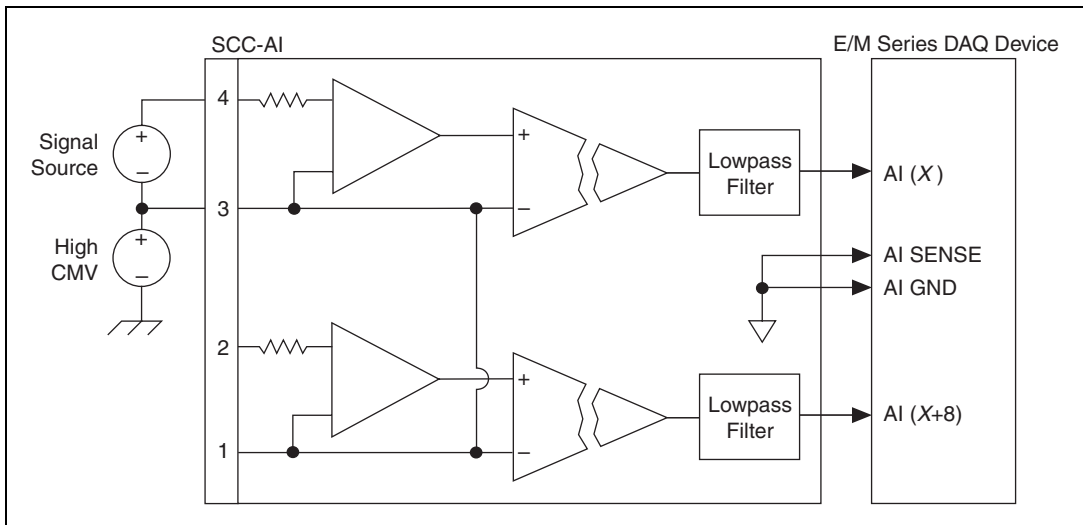

Figure 3. Ground-Referenced Signal Connection for the SCC-AI with High Common-Mode Voltage (One Channel)

For information about how to configure the SCC-AI module using NI-DAQmx, refer to the *SCC Quick Start Guide*.

Using the SCC-AI when Scaling Voltage Measurements

If you configured the SCC-AI using Measurement & Automation Explorer (MAX) and you are using NI-DAQmx, the voltage reading you get from the E/M Series DAQ device accounts for the voltage scaling effect of the SCC-AI. Otherwise, because the voltage measurement from the E/M Series DAQ device is scaled by the gain given in Table 1, you must divide the voltage reading returned by the E/M Series DAQ device by this gain to get the correct input voltage.

Calibrating Gain and Offset Errors

The SCC-AI is calibrated at the factory before shipment. If you want to adjust the gain of the SCC-AI in your system using your E/M Series DAQ device, you need a voltage source that is several times more accurate than the SCC itself and capable of providing the DC voltage shown in Table 2.

Table 2. SCC-AI Input Voltage Requirements

Module	Input Range
SCC-AI01	40 V
SCC-AI02	16 V
SCC-AI03	8 V
SCC-AI04	4 V
SCC-AI05	800 mV
SCC-AI06	80 mV
SCC-AI07	40 mV
SCC-AI13	8 V
SCC-AI14	4 V

Gain Adjustment

To adjust the gain of the SCC-AI, complete the following steps:

1. Select the desired SCC-AI channel on the E/M Series DAQ device.
2. Set the gain on the E/M Series DAQ device so that its input range is ± 10 V.
3. Connect the voltage source to the screw terminals of the desired channel on the SCC-AI.
4. Apply the voltage given in Table 2 that corresponds to the SCC-AI module. For example, if you have an SCC-AI03, you must apply 8 VDC.

5. Using your software, have the E/M Series DAQ device read the desired channel on the SCC-AI and record the value.
6. Input 0 VDC to the SCC-AI.
7. Use the E/M Series DAQ device to read that channel and record the value.
8. Subtract the values read (*first reading – second reading*).
9. Adjust the trimpot labeled *Gain* located on the top of the SCC-AI. If the value you obtained in step 8 is less than the input voltage, turn the trimpot clockwise to increase the gain. If it is greater than the input voltage, turn the trimpot counterclockwise to decrease the gain.
10. Repeat steps 4 through 9 until the difference you get in step 8 equals the Input Voltage Required value shown in Table 2; in this example the value is 8 V using an SCC-AI03.

For example, assume that you have an SCC-AI03 module. You first connect 8 VDC to the input of CH (X). The E/M Series DAQ device reads 8.05 V as the SCC output. You then connect 0 VDC to the input of CH (X) and the E/M Series DAQ device reads –0.01 V as the SCC output. You subtract these readings, $8.05 - (-0.01) = 8.06$, getting a difference of 8.06 V. Because this difference is not equal to 8 V, you must adjust the gain trimpot and repeat the procedure until the difference in outputs equals 8 V.



Note In this example there can be an offset voltage such that the final readings are 8.01 V and 0.01 V for a difference of 8 V. The gain trimpot adjusted in step 9 of the previous procedure adjusts only for gain errors and does not compensate for this offset voltage.

Offset Voltage Adjustment

Complete the following steps to adjust the offset voltage of the SCC-AI:

1. Select the desired SCC-AI channel on the E/M Series DAQ device.
2. Set the gain on the E/M Series DAQ device so that the input range is ± 10 V.
3. Connect the screw terminals of your desired channel on the SCC-AI together.
4. Using your software, have the E/M Series DAQ device read the channel.
5. If the value read is not equal to 0.00 V, adjust the appropriate trimpot located on the top of the SCC-AI, labeled *Offset*. Turn the trimpot clockwise to increase the offset.
6. Repeat steps 4 and 5 until the voltage read in step 4 equals 0.00 V.

Specifications

These ratings are typical at 25 °C unless otherwise stated.

Input Characteristics

Number of input channels	2 NRSE
Isolation	Bank isolation (isolation per module ¹)
Input/output signal range, gain, and bandwidth	Refer to Table 1
Input impedance	
SCC-AI01, SCC-AI02	1 M Ω
All others.....	100 M Ω
Gain error	4.5% max (trimmable to zero)
Gain stability	150 PPM/°C
Offset error	40 mV max (RTI ²)
Offset stability	225 μ V/°C
Nonlinearity	0.0128% typ 0.0260% max
Common-mode rejection ratio	100 dB typical at 60 Hz
Output slew rate, dependent on BW (filtering)	0.8 V/ μ s max

Filter Characteristics

Number of poles.....	3
Rolloff	60 dB/decade
Cutoff frequency (–3 dB)	
AIOX.....	10 kHz
AI1X.....	4 Hz

¹ The SCC-AI does not provide isolation between the two channels of the module. For more information, refer to the [Connecting the Input Signals](#) section.

² This specification is calculated relative to the input range of the module.

Power Requirement

Analog power	410 mW max
+15 V	13.67 mA max
-15 V	13.67 mA max
Digital power (+5 V)	650 mW max
	130 mA max

Physical

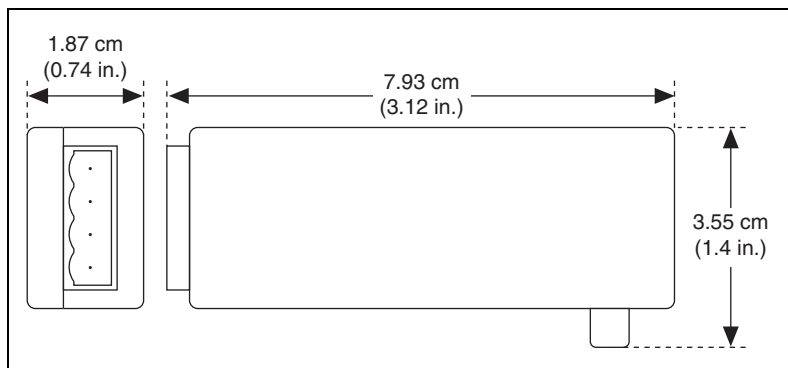

Figure 4. SCC-AI Dimensions

Weight	37 g (1.0 oz)
I/O connectors.....	One 20-pin right-angle male connector, one 4-pin screw terminal, removable
Screw terminal wire gauge	24 to 12 AWG

Maximum Working Voltage

Maximum working voltage refers to the signal voltage plus the common-mode voltage.

Channel-to-earth (inputs).....	42.4 V _{peak} or 60 VDC, Measurement Category I
--------------------------------	---



Caution This device is rated for Measurement Category I and is intended to carry signal voltages no greater than 42.4 V_{peak} or 60 VDC. Do not use this device for connection to signals or for measurements within Categories II, III, or IV.

Isolation Voltage

Channel-to-earth isolation	
Continuous	60 VDC, Measurement Category I
Withstand	2300 V _{rms} verified by a 5 s dielectric withstand type test
Channel-to-channel	Nonisolated ¹

Environmental

Operating temperature.....	0 to 50 °C
Storage temperature	-20 to 70 °C
Humidity	10 to 90% RH, noncondensing
Maximum altitude	2,000 m
Pollution Degree (indoor use only)	2

Safety

This product meets the requirements of the following standards of safety for electrical equipment for measurement, control, and laboratory use:

- IEC 61010-1, EN 61010-1
- UL 61010-1, CSA 61010-1



Note For UL and other safety certifications, refer to the product label or the [Online Product Certification](#) section.

Electromagnetic Compatibility

This product meets the requirements of the following EMC standards for electrical equipment for measurement, control, and laboratory use:

- EN 61326 (IEC 61326): Class A emissions; Basic immunity
- EN 55011 (CISPR 11): Group 1, Class A emissions
- AS/NZS CISPR 11: Group 1, Class A emissions
- FCC 47 CFR Part 15B: Class A emissions
- ICES-001: Class A emissions

¹ The SCC-AI does not provide isolation between the two channels of the module. For more information, refer to the [Connecting the Input Signals](#) section.



Note For the standards applied to assess the EMC of this product, refer to the *Online Product Certification* section.



Note For EMC compliance, operate this product according to the documentation.



Note For EMC compliance, operate this device with shielded cables.

CE Compliance

This product meets the essential requirements of applicable European Directives as follows:

- 2006/95/EC; Low-Voltage Directive (safety)
- 2004/108/EC; Electromagnetic Compatibility Directive (EMC)

Online Product Certification

Refer to the product Declaration of Conformity (DoC) for additional regulatory compliance information. To obtain product certifications and the DoC for this product, visit ni.com/certification, search by model number or product line, and click the appropriate link in the Certification column.

Environmental Management

NI is committed to designing and manufacturing products in an environmentally responsible manner. NI recognizes that eliminating certain hazardous substances from our products is beneficial to the environment and to NI customers.

For additional environmental information, refer to the *NI and the Environment* Web page at ni.com/environment. This page contains the environmental regulations and directives with which NI complies, as well as other environmental information not included in this document.

Waste Electrical and Electronic Equipment (WEEE)



EU Customers At the end of the life cycle, all products *must* be sent to a WEEE recycling center. For more information about WEEE recycling centers and National Instruments WEEE initiatives, visit ni.com/environment/weee.

电子信息产品污染控制管理办法（中国 RoHS）



中国客户 National Instruments 符合中国电子信息产品中限制使用某些有害物质指令 (RoHS)。关于 National Instruments 中国 RoHS 合规性信息, 请登录 ni.com/environment/rohs_china。(For information about China RoHS compliance, go to ni.com/environment/rohs_china.)

SCC-AI Module Pin Assignments

Figure 5 shows the I/O connector pins on the bottom of the module.

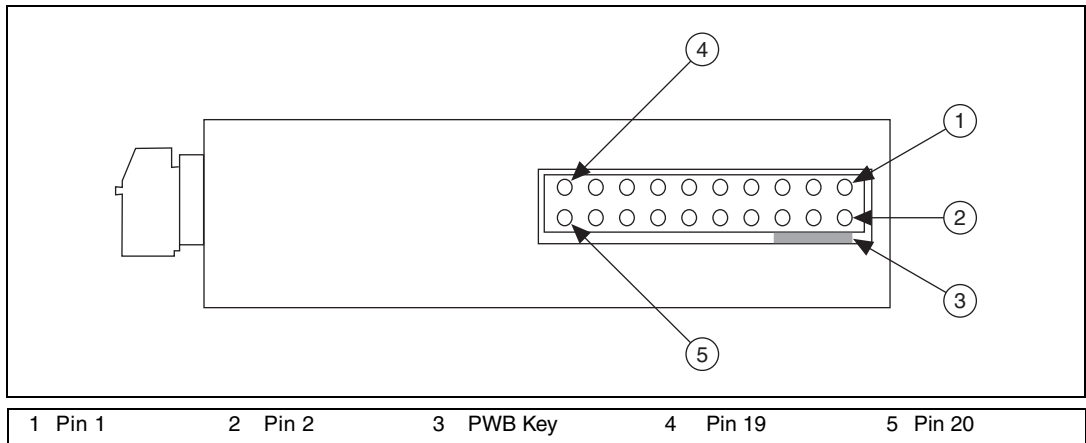

Figure 5. SCC Module Bottom View

Table 3 lists the signal corresponding to each I/O connector pin on the bottom of the SCC-AI. AI (X) and AI ($X+8$) are the analog input channels of the E/M Series DAQ device. AI GND is the analog input ground signal and is the reference for AI (X) and AI ($X+8$). A GND is the reference for the ± 15 V supplies and REF 5 V. AI GND and A GND connect to the SC-2345/2350 at the SCC-PWR connector. GND is the reference for the +5 V supply.

Table 3. SCC-AI Module Pin Assignments

Pin Number	Signal
1	E/M Series AI (X)
2	E/M Series AI GND
3	—
4	E/M Series AI (X+8)
5	—
6	E/M Series AI GND
7	—
8	E/M Series AI GND
9	+5 V
10	GND
11	A GND
12	REF 5 V
13	+15 V
14	-15 V
15	—
16	—
17	—
18	—
19	—
20	—

National Instruments, NI, ni.com, and LabVIEW are trademarks of National Instruments Corporation. Refer to the *Terms of Use* section on ni.com/legal for more information about National Instruments trademarks. Other product and company names mentioned herein are trademarks or trade names of their respective companies. For patents covering National Instruments products/technology, refer to the appropriate location: **Help»Patents** in your software, the `patents.txt` file on your media, or the *National Instruments Patent Notice* at ni.com/patents.