

COMPREHENSIVE SERVICES

We offer competitive repair and calibration services, as well as easily accessible documentation and free downloadable resources.

SELL YOUR SURPLUS

We buy new, used, decommissioned, and surplus parts from every NI series. We work out the best solution to suit your individual needs.

 Sell For Cash  Get Credit  Receive a Trade-In Deal

OBSOLETE NI HARDWARE IN STOCK & READY TO SHIP

We stock **New**, **New Surplus**, **Refurbished**, and **Reconditioned** NI Hardware.



Bridging the gap between the manufacturer and your legacy test system.

 1-800-915-6216

 www.apexwaves.com

 sales@apexwaves.com

All trademarks, brands, and brand names are the property of their respective owners.

Request a Quote

 **CLICK HERE**

SCXI-1128

INSTALLATION INSTRUCTIONS

NI SCXI™-1332

Terminal Block for the NI SCXI-1127/1128

このドキュメントには、日本語ページも含まれています。

This guide describes how to install and connect signals to the National Instruments SCXI-1332 terminal block to configure the SCXI-1127/1128 switch module as a 4 × 8, 2-wire matrix.

Screw terminals on the SCXI-1332 allow you to access the 4 × 8 matrix. The SCXI-1332 also contains terminals for connecting rows and columns between modules using expansion cables.

Refer to the *NI Switches Getting Started Guide* to determine when to install the terminal block. Visit ni.com/switches for information on other switching solutions.

Conventions

The following conventions are used in this guide:

»

The » symbol leads you through nested menu items and dialog box options to a final action. The sequence **File»Page Setup»Options** directs you to pull down the **File** menu, select the **Page Setup** item, and select **Options** from the last dialog box.



This icon denotes a note, which alerts you to important information.



This icon denotes a caution, which advises you of precautions to take to avoid injury, data loss, or a system crash. When this symbol is marked on a product, refer to the *Read Me First: Safety and Radio-Frequency Interference* document for information about precautions to take.

bold

Bold text denotes items that you must select or click in the software, such as menu items and dialog box options. Bold text also denotes parameter names.

italic

Italic text denotes variables, emphasis, a cross reference, or an introduction to a key concept. This font also denotes text that is a placeholder for a word or value that you must supply.

monospace

Text in this font denotes text or characters that you should enter from the keyboard, sections of code, programming examples, and syntax examples. This font is also used for the proper names of disk drives, paths, directories, programs, subprograms, subroutines, device names, functions, operations, variables, filenames and extensions, and code excerpts.

1. Unpack the Terminal Block

To avoid damage in handling the terminal block, take the following precautions:



Caution *Never* touch the exposed pins of connectors.

- Ground yourself using a grounding strap or by touching a grounded object.
- Touch the antistatic package to a metal part of your computer chassis before removing the terminal block from the package.

Remove the terminal block from the package and inspect the terminal block for loose components or any sign of damage. Notify NI if the terminal block appears damaged in any way. Do *not* install a damaged terminal block into your system.

Store the SCXI-1332 in the antistatic envelope when not in use.

2. Verify the Components

Make sure that you have the following items:

- SCXI-1332 terminal block
- SCXI chassis
- SCXI-1127 or SCXI-1128 switch module
- 1/8 in. flathead screwdriver
- Numbers 1 and 2 Phillips screwdrivers
- Long-nose pliers
- Wire cutter

- Wire insulation stripper
- Matrix expansion cables—one cable needed to expand the number of columns, two cables needed to expand the number of rows

3. Connect Signals

To connect the signal(s) to the terminal block, refer to Figures 1 and 2 while completing the following steps:

1. Prepare the signal wire by stripping the insulation no more than 7 mm from the end of the wire.
2. Remove the top cover screw.
3. Unsnap and remove the top cover.
4. Loosen the two strain-relief screws on the strain-relief bar.
5. Run the signal wires through the strain-relief opening.
6. Insert the stripped end of the wire fully into the terminal. Secure the wire by tightening the screw of the terminal. No bare wire should extend past the screw terminal. Exposed wire increases the risk of a short-circuit causing a failure.
7. Connect the safety earth ground to the safety ground lug.
8. Tighten the two screws on the strain-relief assembly to secure the cables.
9. Reinstall the top cover.
10. Replace the top cover screw.

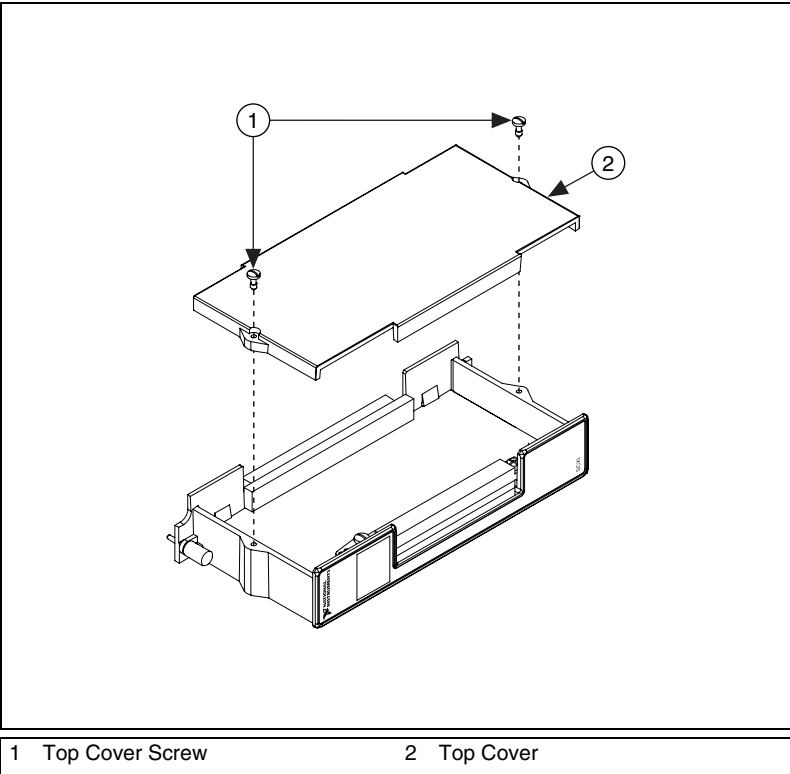

Figure 1. SCXI-1332 Top Cover Diagram

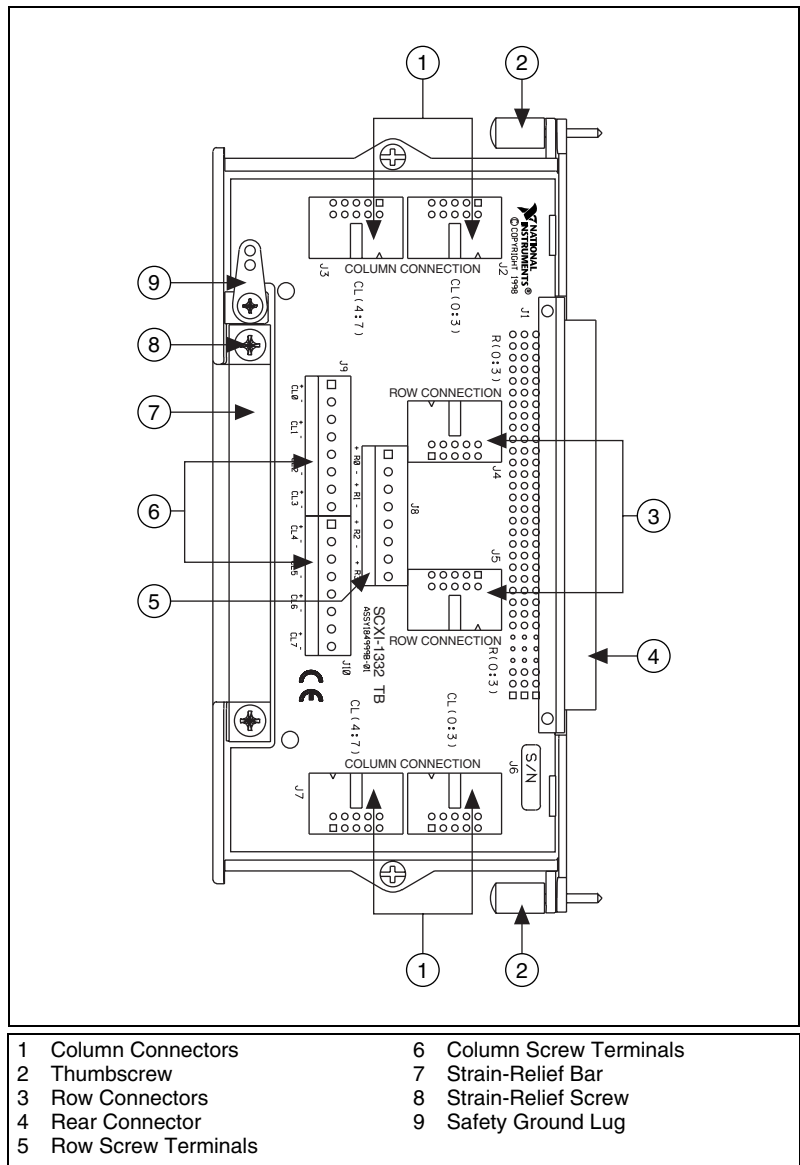

Figure 2. SCXI-1332 Parts Locator Diagram

4. Expand the Number of Columns

The SCXI-1332 offers convenient methods for expanding the number of columns of a matrix using two or more SCXI-1332 terminal blocks. If you are not expanding the number of columns of the matrix, skip to the [6. Install the Terminal Block](#) step. For more information about expanding matrices, refer to the *NI Switches Help*.

Figure 3 shows how to use a matrix expansion cable with SCXI-1332 terminal blocks to expand the number of columns of a 4×8 matrix. The matrix expansion cable connects rows to expand the number of columns. To expand the number of columns of a matrix, complete the following steps:

1. Connect one end of the matrix expansion cable to a row connector in one of the terminal blocks.
2. Connect the other end of the matrix expansion cable to a row connector in another terminal block.

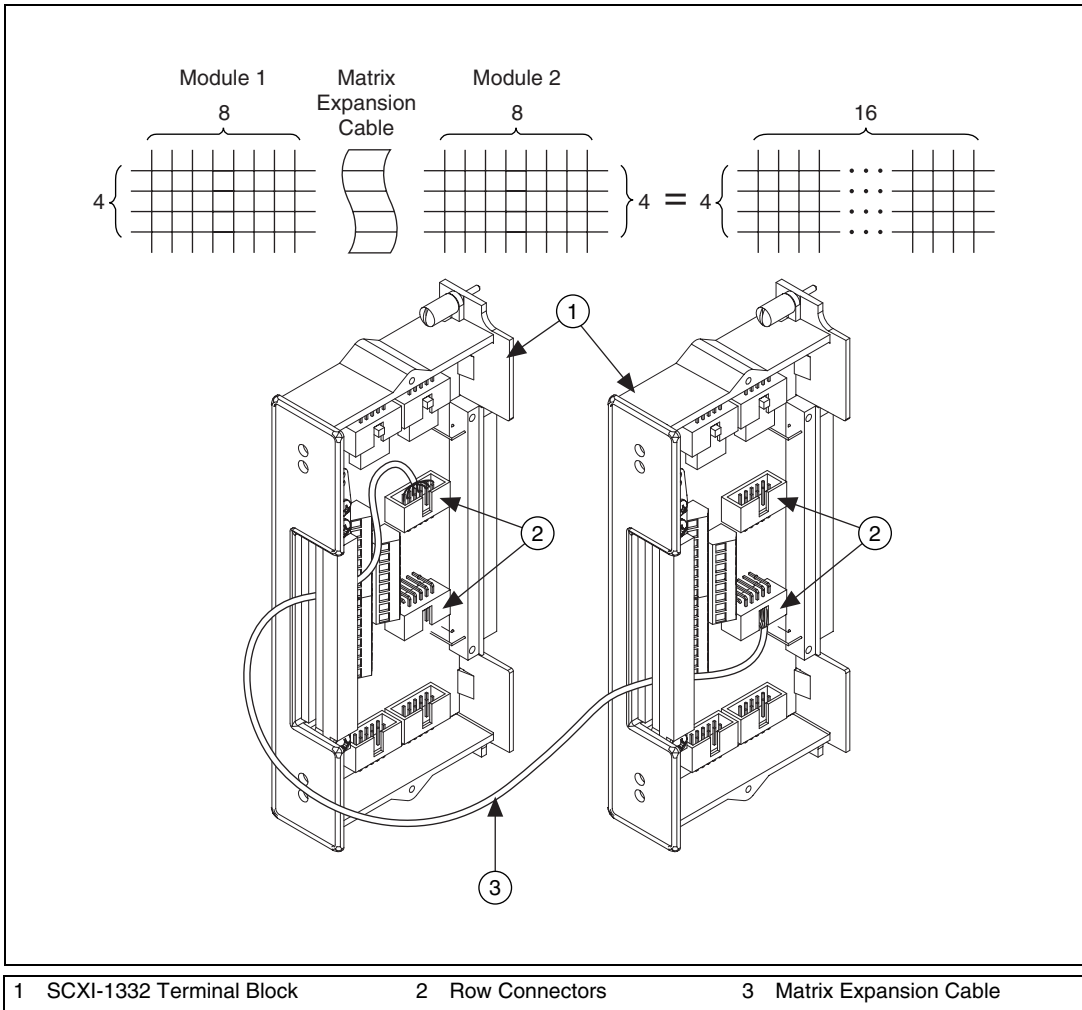

Figure 3. Expanding the Number of Columns with the Matrix Expansion Cable

The SCXI-1332 configures the SCXI-1127/1128 as a 4×8 matrix. Connecting the SCXI-1332 terminal blocks as described above creates a 4×16 matrix.

5. Expand the Number of Rows

The SCXI-1332 offers convenient methods for expanding the number of rows of a matrix using two or more SCXI-1332 terminal blocks.

Figure 4 shows how to use two matrix expansion cables with SCXI-1332 terminal blocks to expand the number of rows of a 4×8 matrix. The matrix expansion cable connects columns to expand the number of rows. To expand the number of rows of a matrix, complete the following steps:

1. Connect one end of a matrix expansion cable to a column connector in one of the terminal blocks.
2. Connect one end of a second matrix expansion cable to another column connector in the same terminal block.
3. Connect the other end of each matrix expansion cable to two column connectors in another terminal block.

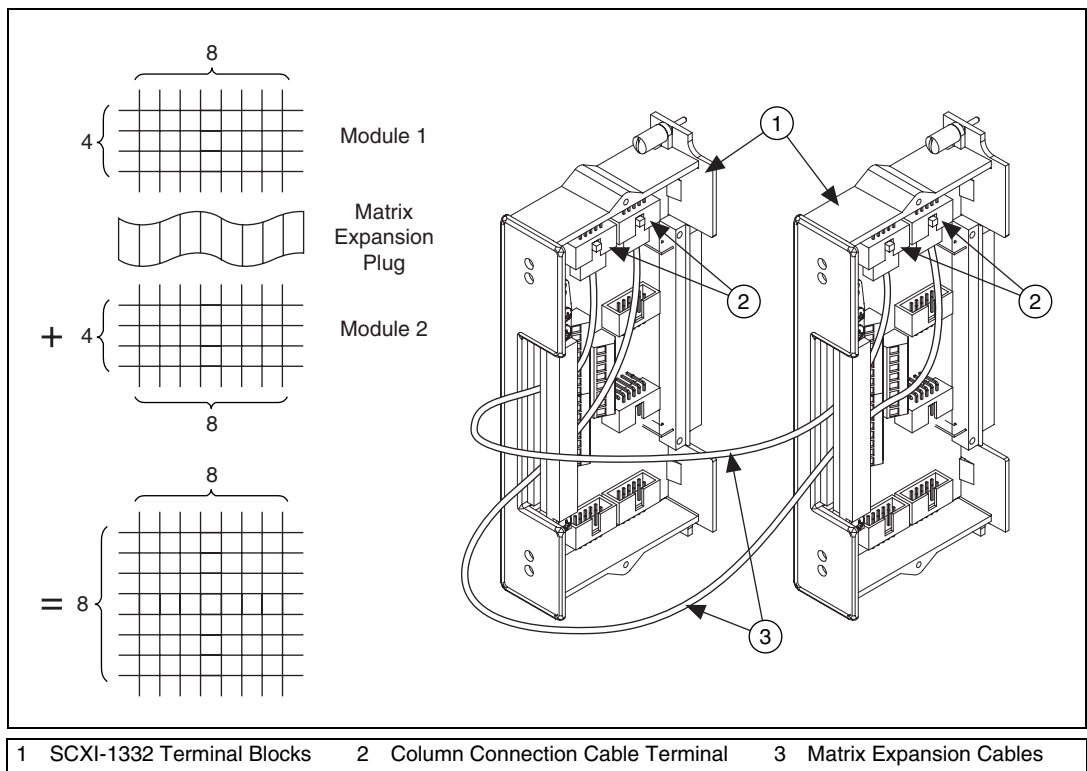

Figure 4. Expanding the Number of Rows with Matrix Expansion Cables

The SCXI-1332 configures the SCXI-1127/1128 as a 4×8 matrix. Connecting the SCXI-1332 terminal blocks as described above creates an 8×8 matrix.

6. Install the Terminal Block

To connect the SCXI-1332 to the SCXI-1127/1128 front connector, complete the following steps:

1. Plug the SCXI-1332 onto the front connector on the SCXI-1127/1128.
2. Tighten the top and bottom thumbscrews on the terminal block rear panel to hold it securely in place.

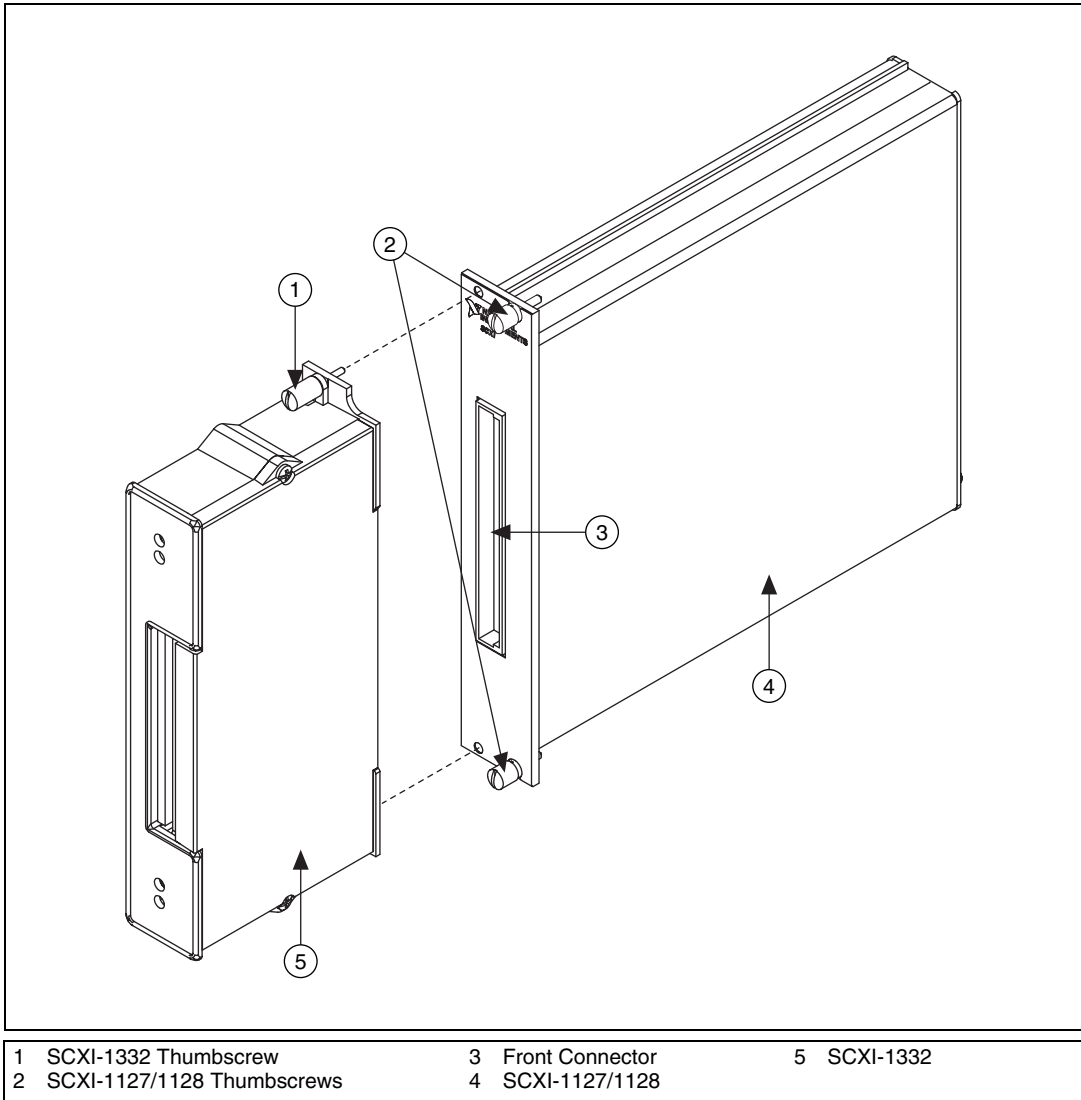

Figure 5. Installing the SCXI-1332 Terminal Block

Specifications

Maximum Voltage

Channel-to-ground 300 V, CAT II



Caution This module is rated for Measurement Category II and intended to carry signal voltages no greater than 300 V. This module features 1390 V_{rms} isolation between input signals and the chassis as verified by a dielectric withstand test, 1 minute maximum. Do *not* use this module for connection to signals or for measurements within Categories III or IV. Refer to the *Read Me First: Safety and Radio-Frequency Interference* document for more information about measurement categories.

Maximum Current

Maximum current
(per channel) 2 ADC, 2 AAC

Environment

The NI SCXI-1332 is intended for indoor use only.

Operating temperature..... 0 °C to 50 °C

Storage temperature –20 °C to 70 °C

Relative humidity 10% to 90% RH, noncondensing

Pollution Degree 2

Approved at altitudes up to 2,000 m.

Safety

This product is designed to meet the requirements of the following standards of safety for electrical equipment for measurement, control, and laboratory use:

- IEC 61010-1, EN 61010-1
- UL 61010-1
- CAN/CSA-C22.2 No. 61010-1



Note For UL and other safety certifications, refer to the product label or visit ni.com/certification, search by model or product line, and click the appropriate link in the Certification column.

Electromagnetic Compatibility

EmissionsEN 55011 Class A at 10 m
FCC Part 15A above 1 GHz

ImmunityEN 61326:1997 + A2:2001,
Table 1

CE, C-Tick, and FCC Part 15 (Class A) Compliant



Note For EMC compliance, operate this device with shielded cabling.

CE Compliance

This product meets the essential requirements of applicable European Directives, as amended for CE marking, as follows:

Low-Voltage Directive (safety).....73/23/EEC

Electromagnetic Compatibility
Directive (EMC)89/336/EEC



Note Refer to the Declaration of Conformity (DoC) for this product for any additional regulatory compliance information. To obtain the DoC for this product, visit ni.com/certification, search by model number or product line, and click the appropriate link in the Certification column.

National Instruments, NI, ni.com, and LabVIEW are trademarks of National Instruments Corporation. Refer to the *Terms of Use* section on ni.com/legal for more information about National Instruments trademarks. Other product and company names mentioned herein are trademarks or trade names of their respective companies. For patents covering National Instruments products, refer to the appropriate location: **Help» Patents** in your software, the `patents.txt` file on your CD, or ni.com/patents.