

## COMPREHENSIVE SERVICES

We offer competitive repair and calibration services, as well as easily accessible documentation and free downloadable resources.

## SELL YOUR SURPLUS

We buy new, used, decommissioned, and surplus parts from every NI series. We work out the best solution to suit your individual needs.

 Sell For Cash    Get Credit    Receive a Trade-In Deal

## OBSOLETE NI HARDWARE IN STOCK & READY TO SHIP

We stock **New**, **New Surplus**, **Refurbished**, and **Reconditioned** NI Hardware.



*Bridging the gap between the manufacturer and your legacy test system.*

 1-800-915-6216

 [www.apexwaves.com](http://www.apexwaves.com)

 [sales@apexwaves.com](mailto:sales@apexwaves.com)

*All trademarks, brands, and brand names are the property of their respective owners.*

**Request a Quote**

 **CLICK HERE**

**SCXI-1163**



**NATIONAL INSTRUMENTS™**  
**Lookout™**

---

# Lookout Object Reference Manual

## **Worldwide Technical Support and Product Information**

ni.com

### **National Instruments Corporate Headquarters**

11500 North Mopac Expressway Austin, Texas 78759-3504 USA Tel: 512 794 0100

### **Worldwide Offices**

Australia 03 9879 5166, Austria 0662 45 79 90 0, Belgium 02 757 00 20, Brazil 011 284 5011,  
Canada (Calgary) 403 274 9391, Canada (Ontario) 905 785 0085, Canada (Québec) 514 694 8521,  
China 0755 3904939, Denmark 45 76 26 00, Finland 09 725 725 11, France 01 48 14 24 24,  
Germany 089 741 31 30, Greece 30 1 42 96 427, Hong Kong 2645 3186, India 91805275406,  
Israel 03 6120092, Italy 02 413091, Japan 03 5472 2970, Korea 02 596 7456, Mexico (D.F.) 5 280 7625,  
Mexico (Monterrey) 8 357 7695, Netherlands 0348 433466, New Zealand 09 914 0488, Norway 32 27 73 00,  
Poland 0 22 528 94 06, Portugal 351 1 726 9011, Singapore 2265886, Spain 91 640 0085,  
Sweden 08 587 895 00, Switzerland 056 200 51 51, Taiwan 02 2528 7227, United Kingdom 01635 523545

For further support information, see the *Technical Support Resources* appendix. To comment on the documentation, send e-mail to [techpubs@ni.com](mailto:techpubs@ni.com)

© Copyright 1996, 2000 National Instruments Corporation. All rights reserved.

# Important Information

---

## Warranty

The media on which you receive National Instruments software are warranted not to fail to execute programming instructions, due to defects in materials and workmanship, for a period of 90 days from date of shipment, as evidenced by receipts or other documentation. National Instruments will, at its option, repair or replace software media that do not execute programming instructions if National Instruments receives notice of such defects during the warranty period. National Instruments does not warrant that the operation of the software shall be uninterrupted or error free.

A Return Material Authorization (RMA) number must be obtained from the factory and clearly marked on the outside of the package before any equipment will be accepted for warranty work. National Instruments will pay the shipping costs of returning to the owner parts which are covered by warranty.

National Instruments believes that the information in this document is accurate. The document has been carefully reviewed for technical accuracy. In the event that technical or typographical errors exist, National Instruments reserves the right to make changes to subsequent editions of this document without prior notice to holders of this edition. The reader should consult National Instruments if errors are suspected. In no event shall National Instruments be liable for any damages arising out of or related to this document or the information contained in it.

EXCEPT AS SPECIFIED HEREIN, NATIONAL INSTRUMENTS MAKES NO WARRANTIES, EXPRESS OR IMPLIED, AND SPECIFICALLY DISCLAIMS ANY WARRANTY OF MERCHANTABILITY OR FITNESS FOR A PARTICULAR PURPOSE. CUSTOMER'S RIGHT TO RECOVER DAMAGES CAUSED BY FAULT OR NEGLIGENCE ON THE PART OF NATIONAL INSTRUMENTS SHALL BE LIMITED TO THE AMOUNT THEREFORE PAID BY THE CUSTOMER. NATIONAL INSTRUMENTS WILL NOT BE LIABLE FOR DAMAGES RESULTING FROM LOSS OF DATA, PROFITS, USE OF PRODUCTS, OR INCIDENTAL OR CONSEQUENTIAL DAMAGES, EVEN IF ADVISED OF THE POSSIBILITY THEREOF. This limitation of the liability of National Instruments will apply regardless of the form of action, whether in contract or tort, including negligence. Any action against National Instruments must be brought within one year after the cause of action accrues. National Instruments shall not be liable for any delay in performance due to causes beyond its reasonable control. The warranty provided herein does not cover damages, defects, malfunctions, or service failures caused by owner's failure to follow the National Instruments installation, operation, or maintenance instructions; owner's modification of the product; owner's abuse, misuse, or negligent acts; and power failure or surges, fire, flood, accident, actions of third parties, or other events outside reasonable control.

## Copyright

Under the copyright laws, this publication may not be reproduced or transmitted in any form, electronic or mechanical, including photocopying, recording, storing in an information retrieval system, or translating, in whole or in part, without the prior written consent of National Instruments Corporation.

## Trademarks

Citadel™, Lookout™, National Instruments™, and ni.com™ are trademarks of National Instruments Corporation.

Product and company names mentioned herein are trademarks or trade names of their respective companies.

## WARNING REGARDING USE OF NATIONAL INSTRUMENTS PRODUCTS

(1) NATIONAL INSTRUMENTS PRODUCTS ARE NOT DESIGNED WITH COMPONENTS AND TESTING FOR A LEVEL OF RELIABILITY SUITABLE FOR USE IN OR IN CONNECTION WITH SURGICAL IMPLANTS OR AS CRITICAL COMPONENTS IN ANY LIFE SUPPORT SYSTEMS WHOSE FAILURE TO PERFORM CAN REASONABLY BE EXPECTED TO CAUSE SIGNIFICANT INJURY TO A HUMAN.

(2) IN ANY APPLICATION, INCLUDING THE ABOVE, RELIABILITY OF OPERATION OF THE SOFTWARE PRODUCTS CAN BE IMPAIRED BY ADVERSE FACTORS, INCLUDING BUT NOT LIMITED TO FLUCTUATIONS IN ELECTRICAL POWER SUPPLY, COMPUTER HARDWARE MALFUNCTIONS, COMPUTER OPERATING SYSTEM SOFTWARE FITNESS, FITNESS OF COMPILERS AND DEVELOPMENT SOFTWARE USED TO DEVELOP AN APPLICATION, INSTALLATION ERRORS, SOFTWARE AND HARDWARE COMPATIBILITY PROBLEMS, MALFUNCTIONS OR FAILURES OF ELECTRONIC MONITORING OR CONTROL DEVICES, TRANSIENT FAILURES OF ELECTRONIC SYSTEMS (HARDWARE AND/OR SOFTWARE), UNANTICIPATED USES OR MISUSES, OR ERRORS ON THE PART OF THE USER OR APPLICATIONS DESIGNER (ADVERSE FACTORS SUCH AS THESE ARE HEREAFTER COLLECTIVELY TERMED "SYSTEM FAILURES"). ANY APPLICATION WHERE A SYSTEM FAILURE WOULD CREATE A RISK OF HARM TO PROPERTY OR PERSONS (INCLUDING THE RISK OF BODILY INJURY AND DEATH) SHOULD NOT BE RELIANT SOLELY UPON ONE FORM OF ELECTRONIC SYSTEM DUE TO THE RISK OF SYSTEM FAILURE. TO AVOID DAMAGE, INJURY, OR DEATH, THE USER OR APPLICATION DESIGNER MUST TAKE REASONABLY PRUDENT STEPS TO PROTECT AGAINST SYSTEM FAILURES, INCLUDING BUT NOT LIMITED TO BACK-UP OR SHUT DOWN MECHANISMS. BECAUSE EACH END-USER SYSTEM IS CUSTOMIZED AND DIFFERS FROM NATIONAL INSTRUMENTS' TESTING PLATFORMS AND BECAUSE A USER OR APPLICATION DESIGNER MAY USE NATIONAL INSTRUMENTS PRODUCTS IN COMBINATION WITH OTHER PRODUCTS IN A MANNER NOT EVALUATED OR CONTEMPLATED BY NATIONAL INSTRUMENTS, THE USER OR APPLICATION DESIGNER IS ULTIMATELY RESPONSIBLE FOR VERIFYING AND VALIDATING THE SUITABILITY OF NATIONAL INSTRUMENTS PRODUCTS WHENEVER NATIONAL INSTRUMENTS PRODUCTS ARE INCORPORATED IN A SYSTEM OR APPLICATION, INCLUDING, WITHOUT LIMITATION, THE APPROPRIATE DESIGN, PROCESS AND SAFETY LEVEL OF SUCH SYSTEM OR APPLICATION.

# Contents

---

## About This Manual

Conventions .....	xxv
Related Documentation.....	xxvi

## Chapter 1

### Introduction to the Lookout Object Class Reference

## Chapter 2

### Lookout System Objects

Accumulator.....	2-2
Accumulator Data Members.....	2-3
ActiveX.....	2-4
Creating a Lookout ActiveX Object.....	2-5
ActiveX Control Properties .....	2-10
ActiveX Verbs.....	2-11
ActiveX Object Data Members .....	2-11
Aggregate.....	2-13
Creating an Aggregate Definition Process .....	2-15
Object Parameters in an Aggregate Definition Process .....	2-15
Naming and Numbering Lookout Object Parameters .....	2-16
Saving a Process as an Aggregate Definition.....	2-17
Exposing Data Members in an Aggregate Definition Process.....	2-17
Exposing Parameters in an Aggregate Definition Process.....	2-21
Creating and Configuring an Aggregate Object.....	2-22
Making Connections and Editing the Database for Aggregate Objects .....	2-23
Alarm .....	2-24
Alarm Data Members .....	2-26
\$Alarm .....	2-27
\$Alarm Data Members .....	2-28
Using \$Alarm with Other Objects.....	2-29
Alternator.....	2-30
Using the Alternator .....	2-31
Connecting the Alternator .....	2-31
Command and Advance .....	2-32
Maximum Run Time and Delay Operation .....	2-33
Hand-Off-Auto Modes .....	2-33
Elapsed Time, Run Time, and Reset .....	2-34

Alternator Data Members.....	2-34
Alternator Status Messages .....	2-36
Animator.....	2-38
Animations .....	2-39
Color Animation .....	2-40
Animator Data Members.....	2-42
Average.....	2-43
Average Data Members .....	2-43
Counter .....	2-45
Counter Data Members .....	2-45
DataSocket.....	2-46
Accessing DataSocket Arrays.....	2-47
Configuring the DataSocket Object to Write to an Array .....	2-47
Configuring DataSocket Object Data Members to Access an Array.....	2-48
DataSocket Data Members.....	2-49
DataSocket Status Messages .....	2-50
DataTable .....	2-51
Multiplexing Displays and Graphics .....	2-53
DataTable Example.....	2-55
Connecting Signals to DataTables.....	2-56
The Display Panel.....	2-60
Operating Your Multiplexed Panel .....	2-61
DataTable Cursors.....	2-61
Using Multiple Cursors .....	2-63
DataTable Data Members .....	2-64
DdeLink.....	2-67
DdeLinks on Same Computer .....	2-67
DdeLinks to Remote Computer .....	2-67
DdeLink Data Members.....	2-68
DdeTable .....	2-69
DdeTable on Same Computer .....	2-69
DdeTable to Remote Computer .....	2-71
DDETable Data Members.....	2-72
DelayOff.....	2-73
DelayOff Data Members .....	2-73
DelayOn.....	2-74
DelayOn Data Members.....	2-74
Derivative .....	2-75
Derivative Data Members .....	2-76
DialGauge.....	2-77
DialGauge Data Members.....	2-79
ElapsedTime .....	2-81
ElapsedTime Data Members.....	2-81

Event .....	2-82
Event Data Members .....	2-82
(expression) .....	2-83
Flipflop .....	2-85
Flipflop Data Member .....	2-85
Gauge .....	2-86
Gauge Data Members .....	2-87
Histogram .....	2-88
Histogram Data Members .....	2-90
HyperTrend .....	2-92
HyperTrend Data Members .....	2-99
Converting Lookout 3.xx HyperTrends to Lookout 4 and Greater .....	2-101
Integral .....	2-102
Integral Data Members .....	2-103
Interpolate .....	2-104
Interpolate Data Members .....	2-107
Interval .....	2-108
Interval Data Members .....	2-108
Joystick .....	2-109
Joystick Data Members .....	2-109
Junction .....	2-111
Junction Data Members .....	2-111
\$Keyboard .....	2-112
\$Keyboard Data Members .....	2-113
L3Pot .....	2-115
L3Pot Data Members .....	2-117
L3Pushbutton .....	2-120
L3Pushbutton Data Members .....	2-122
L3Switch .....	2-123
L3Switch Data Members .....	2-125
L3TextEntry .....	2-126
L3TextEntry Data Members .....	2-127
LatchGate .....	2-128
LatchGate Data Members .....	2-128
Loader .....	2-129
Loader Data Members .....	2-131
Loader Error Messages .....	2-132
Mailer .....	2-134
Mailer Object Data Members .....	2-136
Maximum .....	2-137
Maximum Data Members .....	2-137
Minimum .....	2-139
Minimum Data Members .....	2-139

Monitor .....	2-141
Monitor Data Members .....	2-141
Mouse .....	2-142
Mouse Data Members .....	2-142
Multistate .....	2-143
Multistate Data Members .....	2-144
Neutralzone.....	2-145
Neutralzone Data Members .....	2-146
Numeric Format.....	2-147
Numeric Format Data Members .....	2-147
OneShot .....	2-148
OneShot Data Members .....	2-149
Pager .....	2-150
Pager Data Members .....	2-152
Pager Object Modes .....	2-152
Numeric Only .....	2-152
Alphanumeric Mode .....	2-152
Pager Queueing .....	2-153
Pager Status Messages .....	2-153
Panel .....	2-154
Manipulating Panels.....	2-157
Panel Switching.....	2-157
Special Considerations for “Home Panel” .....	2-159
Programmable Control of Panels .....	2-159
Panel Print .....	2-160
Screen Resolution and Lookout Graphics.....	2-160
Panel Data Members .....	2-161
Pareto.....	2-164
Weighted or Unweighted Charts.....	2-166
Incrementing Factor Counts.....	2-167
Pareto Data Members.....	2-168
PID.....	2-170
PID Positional Control .....	2-173
PID Velocity Control .....	2-173
PID Data Members.....	2-174
Pipe .....	2-176
Pipe Data Members .....	2-176
Playwave.....	2-177
Playwave Data Members .....	2-177
Pot.....	2-178
Pot Data Members.....	2-180
Pulse .....	2-183
Pulse Data Members .....	2-183



PushButton .....	2-185
PushButton Data Members .....	2-188
RadioButton .....	2-190
RadioButton Data Members .....	2-193
Recipe .....	2-194
Recipe Data Members .....	2-199
Report.....	2-201
Placing Elements on the Report Page.....	2-202
Generating the Report Page.....	2-203
Making A Report Page Available.....	2-203
Report Data Members.....	2-204
Run .....	2-209
Sample .....	2-211
Sample Data Members .....	2-211
SampleText .....	2-213
SampleText Data Members .....	2-213
Scale.....	2-214
Scale Data Members.....	2-215
Sequencer.....	2-216
Programming the Sequencer.....	2-217
Sequencer Data Members.....	2-218
Sort.....	2-219
Sort Data Members.....	2-220
Spinner .....	2-221
Spinner Data Members .....	2-222
Spreadsheet .....	2-223
Spreadsheet Data Members .....	2-226
SqlExec .....	2-227
SqlExec Data Members .....	2-228
SqlExec Comments .....	2-229
SQL Command Buffering .....	2-230
SqlExec Status Messages .....	2-232
Switch .....	2-234
Switch Data Members .....	2-236
Symbolic Links .....	2-238
Symbolic Link Connection Persistence.....	2-240
\$System.....	2-241
\$System Data Members.....	2-241
TextEntry .....	2-242
TextEntry Data Members .....	2-244
TimeOfxxxx.....	2-246
Timeofxxxx Data Members.....	2-247
Trend.....	2-248
Trend Data Members .....	2-252

Waveform .....	2-253
Waveform Data Members .....	2-254
Waveform Comments .....	2-255
XBarR .....	2-256
XBarR Data Members .....	2-259
XChart .....	2-262
XChart Data Members .....	2-263
XYChart .....	2-266
XYChart Data Members .....	2-267

## Chapter 3

### Lookout Driver and Protocol Objects

AB-Logix	
AB_PLC2,	
AB_PLC5,	
AB_SLC500 .....	3-2
Allen-Bradley Serial Port Interface Parameters .....	3-4
Allen-Bradley DH+ Interface Parameters .....	3-5
Allen-Bradley Ethernet Interface Parameters .....	3-8
Using the 5136-SD card from S-S Technologies, Inc. ....	3-9
Allen-Bradley Register Addressing .....	3-10
Allen-Bradley Data Members .....	3-10
Allen-Bradley Error Messages .....	3-20
AdvantechPCL .....	3-26
AdvantechPCL Data Members .....	3-27
Applicom .....	3-28
Applicom Data Members .....	3-30
General Information on Using the Applicom drivers for Lookout .....	3-48
Applicom Local and Image Modes .....	3-48
Configuration of the Applicom Server .....	3-49
Loading of the Applicom Server .....	3-49
Testing the Applicom Server .....	3-50
Creating the Cyclic Functions .....	3-50
Special Instructions on Using the Applicom Local Object Class .....	3-51
Applicom Status Messages .....	3-51
Aquatrol .....	3-54
RTU Configuration Dialog Box .....	3-55
Aquatrol Data Members .....	3-56
Aquatrol Status Messages .....	3-57
ASCII .....	3-59
ASCII Data Members .....	3-60
Request and Response Format Strings .....	3-62
ASCII Object Markers .....	3-63

Entering ASCII Object Format String .....	3-66
Request Frame Construction Examples .....	3-67
Response Format Examples .....	3-67
Using Sum Data Members.....	3-68
ASCII Error Messages.....	3-69
Cutler-Hammer .....	3-70
Cutler-Hammer Data Members .....	3-72
Cutler-Hammer Status Messages .....	3-73
DeltaTau.....	3-75
DeltaTau Data members .....	3-75
DL205,	
DL405 .....	3-77
DL205 and DL405 Data Members .....	3-79
DL205 and DL405 Status Messages .....	3-81
DNP .....	3-83
DNP Data Members .....	3-84
Error Messages .....	3-86
Dynamic.....	3-88
Dynamic Data Members.....	3-90
Fatek MA/MB/MC .....	3-94
Fatek Data Members.....	3-95
Fatek Status Messages.....	3-98
FisherROC .....	3-99
FisherROC Data Members .....	3-101
FisherROC Status Messages.....	3-104
GE_Series90 .....	3-106
GE_Series90 Data Members .....	3-107
GE_Series90 Status Messages.....	3-110
Hitachi.....	3-112
Hitachi Data Members.....	3-114
Hitachi Status Messages .....	3-115
IPASCII .....	3-116
IPASCII Data Members .....	3-117
Request and Response Format Strings .....	3-118
Markers.....	3-119
Entering the Format String .....	3-122
Request Frame Construction Examples.....	3-122
Response Format Examples .....	3-122
IPASCII Error Messages .....	3-123
Mitsubishi	
MitsubishiFX .....	3-125
Mitsubishi Data Members .....	3-127
Mitsubishi Status Messages.....	3-128
Mitsubishi Models Supported.....	3-129

Mitsubishi CLM .....	3-130
Mitsubishi CLM Device Configuration and Equipment.....	3-131
Mitsubishi CLM Data Members .....	3-131
Mitsubishi CLM Status Messages.....	3-133
Mitsubishi Models Supported .....	3-134
Modbus	
ModbusMOSCAD.....	3-135
Advanced Modbus Parameters.....	3-138
Modbus Protocol Statistics.....	3-140
Modbus Data Members .....	3-142
ModbusMOSCAD Data Members.....	3-146
Modbus Daniel .....	3-148
Modbus Daniel Data Members .....	3-149
Modbus OmniFlow.....	3-152
Modbus OmniFlow Data Members.....	3-153
Modbus OmniFlow Status Messages.....	3-154
ModbusSlave .....	3-156
Modbus Slave Data Members .....	3-157
NIDeviceNet	
NIDeviceNetExplicit .....	3-159
NIDeviceNet Object Class .....	3-160
NIDeviceNetExplicit Object Class .....	3-161
Configuring Your DeviceNet Card for Lookout.....	3-163
NIDeviceNet Data Members.....	3-164
NIDeviceNetExplicit Messaging Data Members.....	3-165
Example .....	3-165
DeviceNet Error Messages.....	3-166
National Instruments Fieldbus.....	3-167
Fieldbus Alarms .....	3-169
Fieldbus Data Members .....	3-169
Fieldbus Status Messages.....	3-170
Fieldbus Troubleshooting .....	3-171
National Instruments FieldPoint.....	3-172
FieldPoint Filtering for Counter Overflow Alarms.....	3-174
FieldPoint Data Members .....	3-175
FieldPoint Multiple Discrete Data Members .....	3-177
FieldPoint FPTB-10 Module Data Members .....	3-178
FieldPoint Error Messages .....	3-179
National Instruments Lookout OPC Client .....	3-182
Using OPC with Lookout.....	3-184
OPCClient Performance .....	3-185
Editing the OPCClient Database .....	3-185
Security and OPC Client/Server .....	3-185

OPC Client Data Members .....	3-186
Examples .....	3-188
NIDAQDevice .....	3-189
NIDAQDevice Data Members .....	3-190
NIDAQ.INI .....	3-191
NIDAQDevice Error Messages .....	3-191
NISCXI .....	3-193
NISCXI Data Members .....	3-195
Configuring NIDAQ.INI for NISCXI .....	3-196
Channel Attributes .....	3-196
Cold-Junction Sensor Attributes .....	3-196
NISCXI Error Messages .....	3-196
SCXI Devices .....	3-197
Omron .....	3-199
Omron Data Members .....	3-201
Omron Status Messages .....	3-202
Omron Models Supported .....	3-203
OptoHostWords .....	3-204
Configuring the Hostwords Controller .....	3-206
OptoHostWords Data Members .....	3-207
OptoHostWords Status Messages .....	3-209
OptoHostwords TCP/IP Errors .....	3-210
Lookout Driver Errors with OptoHostWords .....	3-210
HostWords Errors .....	3-210
OptoMistic .....	3-214
OptoMistic Data Members .....	3-215
OptoMistic Error Messages .....	3-217
Optomux .....	3-218
Optomux Watchdog Capability .....	3-220
Optomux Data Members .....	3-221
Optomux Status Messages .....	3-222
Philips .....	3-224
Philips Data Members .....	3-226
Philips Status Messages .....	3-227
Philips Alarms .....	3-227
Phoneducer .....	3-228
Phoneducer Data Members .....	3-229
Phoneducer Status Messages .....	3-230
Profibus DP .....	3-231
Configuring the Profibus DP Network .....	3-231
Profibus DP Requirements .....	3-231
PFB Card Settings .....	3-232
Profibus DP Data Members .....	3-233
Profibus DP Status Messages .....	3-234

ProfibusL2 .....	3-235
Lookout Messaging System .....	3-235
Sample Program .....	3-235
Detailed Explanation of the Profibus Example Program .....	3-236
DB1 Configuration .....	3-236
Function Block Explanation .....	3-237
ProfibusL2 Requirements .....	3-238
PFB Card Settings .....	3-239
ProfibusL2 Data Members .....	3-240
ProfibusL2 Status Messages .....	3-241
Reliance .....	3-242
PC-Link Card Settings .....	3-243
Destination Settings .....	3-243
Reliance Data Members .....	3-243
Reliance Data Members .....	3-244
Reliance Status Messages .....	3-244
RKC F Series .....	3-245
RKC Data Members .....	3-247
RKC Status Messages .....	3-254
S5_3964 .....	3-255
S5_3964 Data Members .....	3-256
S5_3964 Alarms .....	3-259
S5_AS511 .....	3-261
S5_AS511 Data Members .....	3-262
S5_AS511 Alarms .....	3-264
Scan-Data Driver .....	3-266
Scan-Data Data Members .....	3-267
Scan-Data Status Messages .....	3-268
Siemens S7_HMI .....	3-270
Special Serial Port Configuration .....	3-271
Siemens S7_HMI Data Members .....	3-272
Siemens S7_HMI Status Messages .....	3-273
Siemens TI505 .....	3-275
Configuring HI-TF .....	3-276
Siemens TI505 Data Members .....	3-278
Siemens TI505 Status Messages .....	3-282
Sixnet .....	3-283
Sixnet Data Members .....	3-284
Importing Sixtags Database .....	3-287
Sixnet Status Messages .....	3-288
SquareD .....	3-289
Serial Port Interface Parameters .....	3-290
SY/LINK Interface Parameters .....	3-291
SY/ENET Interface Parameters .....	3-292

Using SY/ENET with More Than One Ethernet Board in Your System .....	3-293
SquareD Data Members .....	3-294
SquareD Error Messages .....	3-296
Tesco .....	3-297
Tesco Data Members .....	3-299
Tiway .....	3-301
Update Write Settings.....	3-302
Communication Techniques.....	3-303
Local Port.....	3-303
Unilink Host Adapter.....	3-303
Unilink PC Adapter.....	3-304
CTI TCP/IP .....	3-305
Tiway Data Members .....	3-306
Importing APT Name Files .....	3-310
Toshiba Mseries/Toshiba Tseries .....	3-311
Toshiba Data Members.....	3-313
Toshiba Status Messages.....	3-315
Wizdom.....	3-316
Wizdom Data Members.....	3-317

## Appendix A Object Class Parameters

## Appendix B Technical Support Resources

## Glossary

## Figures

Figure 2-1.	Accumulator Definition Parameters Dialog Box .....	2-2
Figure 2-2.	Typical Settings for a Logical Style Alarm.....	2-24
Figure 2-3.	Typical Settings for a Numeric Style Alarm.....	2-25
Figure 2-4.	Edit Connections Dialog Box for using \$Alarm .....	2-27
Figure 2-5.	Select Graphic Dialog Box.....	2-38
Figure 2-6.	Animator Definition Parameters Dialog Box, Animation Tab.....	2-39
Figure 2-7.	Animator Definition Parameters Dialog Box, Color Tab.....	2-41
Figure 2-8.	Average Definition Parameters Dialog Box.....	2-43
Figure 2-9.	Counter Definition Parameters Dialog Box .....	2-45
Figure 2-10.	DataTable Definition Parameters Dialog Box.....	2-51
Figure 2-11.	DataTable Definition Parameters Dialog Box; Import from ODBC Database.....	2-53

Figure 2-12.	Graphical Representation of a DataTable Showing Connections.....	2-54
Figure 2-13.	Edit Connections Dialog Box .....	2-57
Figure 2-14.	Edit Connections Dialog Box .....	2-58
Figure 2-15.	DataTable with Cursor at Row 2 and Corresponding Outputs .....	2-62
Figure 2-16.	DataTable with Cursor at Row 9 and Corresponding Outputs .....	2-63
Figure 2-17.	DdeLink Definition Parameters Dialog Box (Same Computer) .....	2-67
Figure 2-18.	DdeLink Definition Parameters Dialog Box (Remote Computer) .....	2-68
Figure 2-19.	DdeTable Definition Parameters Dialog Box (Same Computer) .....	2-69
Figure 2-20.	Inserting a DdeTable Expression .....	2-70
Figure 2-21.	DdeTable Definition Parameters Dialog Box (Remote Computer).....	2-71
Figure 2-22.	DelayOff Definition Parameters Dialog Box.....	2-73
Figure 2-23.	DelayOn Definition Parameters Dialog Box .....	2-74
Figure 2-24.	Derivative Definition Parameters Dialog Box.....	2-75
Figure 2-25.	DialGauge Definition Parameters Dialog Box .....	2-77
Figure 2-26.	DialGauge Display Parameters Dialog Box .....	2-78
Figure 2-27.	ElapsedTime Definition Parameters Dialog Box.....	2-81
Figure 2-28.	Typical Settings for an Event.....	2-82
Figure 2-29.	Create Expression Dialog Box.....	2-83
Figure 2-30.	Flipflop Definition Parameters Dialog Box.....	2-85
Figure 2-31.	Gauge Definition Parameters Dialog Box .....	2-86
Figure 2-32.	Histogram Definition Parameters Dialog Box.....	2-88
Figure 2-33.	Graph from Inserting Ten Numeric Expression Barcharts (Data Members f0 through f9 as Shown) and Two Scales .....	2-89
Figure 2-34.	HyperTrend Cursor Dialog Box.....	2-94
Figure 2-35.	Integral Definition Parameters Dialog Box .....	2-102
Figure 2-36.	Interpolate Definition Parameters Dialog Box .....	2-104
Figure 2-37.	Interval Definition Parameters Dialog Box .....	2-108
Figure 2-38.	Junction Definition Parameters Dialog Box .....	2-111
Figure 2-39.	Edit Connections Dialog Box .....	2-112
Figure 2-40.	L3Pot Definitions Parameters Dialog Box .....	2-115
Figure 2-41.	L3Pot Display Parameters Dialog Box .....	2-117
Figure 2-42.	L3Pushbutton Definitions Parameters Dialog Box.....	2-120
Figure 2-43.	Verification Message Dialog Box.....	2-121
Figure 2-44.	L3Switch Definition Parameters Dialog Box .....	2-123
Figure 2-45.	Verification Message Dialog Box.....	2-123
Figure 2-46.	TextEntry Parameters Dialog Box.....	2-126
Figure 2-47.	LatchGate Definition Parameters Dialog Box .....	2-128
Figure 2-48.	Maximum Configuration Parameters Dialog Box .....	2-137
Figure 2-49.	Minimum Configuration Parameters Dialog Box.....	2-139
Figure 2-50.	Multistate Configuration Parameters Dialog Box.....	2-143
Figure 2-51.	Neutralzone Definition Parameters Dialog Box .....	2-145
Figure 2-52.	OneShot Definition Parameters Dialog Box.....	2-148
Figure 2-53.	Numeric Only Pager Definition Parameters Dialog Box.....	2-150
Figure 2-54.	Alphanumeric Pager Definition Parameters Dialog Box.....	2-150



Figure 2-55.	Panel Definition and Display Parameters Dialog Box .....	2-154
Figure 2-56.	Pareto Definition Parameters Dialog Box .....	2-164
Figure 2-57.	Pareto Display Parameters Dialog Box .....	2-165
Figure 2-58.	Unweighted Pareto Chart .....	2-166
Figure 2-59.	Weighted Pareto Chart .....	2-167
Figure 2-60.	PID Definition Parameters Dialog Box .....	2-170
Figure 2-61.	Pipe Definition Parameters Dialog Box .....	2-176
Figure 2-62.	Playwave Definitions Parameters Dialog Box .....	2-177
Figure 2-63.	Pot Definitions Parameters Dialog Box .....	2-178
Figure 2-64.	Pot Display Parameters Dialog Box .....	2-180
Figure 2-65.	Pulse Definition Parameters Dialog Box.....	2-183
Figure 2-66.	PushButton Definitions Parameters Dialog Box.....	2-185
Figure 2-67.	Verification Message Dialog Box .....	2-186
Figure 2-68.	RadioButton Definition Parameters Dialog Box.....	2-190
Figure 2-69.	RadioButton Display Parameters Dialog Box.....	2-192
Figure 2-70.	RadioButton Display Parameters Dialog Box with Custom Graphics Chosen .....	2-192
Figure 2-71.	Recipe Definition Parameters Dialog Box .....	2-195
Figure 2-72.	Recipe Object Display Parameters Box .....	2-198
Figure 2-73.	Run Definition Parameters Dialog Box.....	2-209
Figure 2-74.	Sample Configuration Parameters Dialog Box .....	2-211
Figure 2-75.	SampleText Definition Parameters Dialog Box.....	2-213
Figure 2-76.	Scale Definition Parameters Dialog Box.....	2-214
Figure 2-77.	Scale Display Parameters Dialog Box.....	2-215
Figure 2-78.	Sequencer Definition Parameters Dialog Box.....	2-216
Figure 2-79.	Spinner Definition Parameters Dialog Box.....	2-221
Figure 2-80.	Spreadsheet Configuration Parameters Dialog Box .....	2-223
Figure 2-81.	SqlExec Configuration Parameters Dialog Box.....	2-227
Figure 2-82.	Switch Definition Parameters Dialog Box .....	2-234
Figure 2-83.	Verification Message Dialog Box .....	2-234
Figure 2-84.	TextEntry Parameters Dialog Box .....	2-242
Figure 2-85.	TextEntry Display Parameters Dialog Box .....	2-244
Figure 2-86.	TimeOfDay Definition Parameters Dialog Box.....	2-246
Figure 2-87.	XBarR Definition Parameters Dialog Box .....	2-256
Figure 2-88.	XBarR Display Parameters Dialog Box.....	2-257
Figure 2-89.	X-Bar Chart Showing Upper Control Limit, Center Line, and Lower Control Limits .....	2-258
Figure 2-90.	R Chart Showing Upper Control Limit, Center Line, and Lower Control Limits as Calculated Based on Plotted Samples .....	2-258
Figure 2-91.	XChart Definition Parameters Dialog Box .....	2-262
Figure 2-92.	XChart Display Parameters Dialog Box .....	2-263
Figure 2-93.	XYChart Definition Parameters Dialog Box.....	2-266
Figure 2-94.	XYChart Display Parameters Dialog Box.....	2-267

Figure 3-1.	Allen-Bradley Parameter Dialog Box .....	3-3
Figure 3-2.	AB_SLC-500 Definition Parameters Dialog Box Configured for DH+ Communications.....	3-5
Figure 3-3.	AB_PLC5 Definition Parameters Dialog Box Configured for Ethernet Communications .....	3-8
Figure 3-4.	AB_PLC5 Definition Parameters Dialog Box Configured for the 5136-SD card.....	3-9
Figure 3-5.	AdvantechPCL Definition Parameters Dialog Box .....	3-26
Figure 3-6.	Applicom Definition Parameters Dialog Boxes .....	3-28
Figure 3-7.	Aquatrol Definition Parameters Dialog Box.....	3-54
Figure 3-8.	RTU Configuration Dialog Box.....	3-55
Figure 3-9.	ASCII Definition Parameters Dialog Box .....	3-59
Figure 3-10.	Cutler-Hammer Definition Parameters Dialog Box .....	3-70
Figure 3-11.	DL205 Parameters Configured for one PLC in a Multidropped Configuration .....	3-77
Figure 3-12.	Dynamic Parameter Configuration Dialog Box.....	3-89
Figure 3-13.	FisherROC Definition Parameters Dialog Box.....	3-99
Figure 3-14.	GE_Series90 Definition Parameters Dialog Box.....	3-106
Figure 3-15.	Hitachi Definition Parameters Dialog Box .....	3-112
Figure 3-16.	Mitsubishi Configuration Parameters Dialog Box.....	3-125
Figure 3-17.	Modbus Configuration Parameters Dialog Box.....	3-136
Figure 3-18.	Advanced Modbus Parameters Dialog Box .....	3-139
Figure 3-19.	Modbus Protocol Statistics Dialog Box.....	3-141
Figure 3-20.	Modbus Slave Configuration Parameters Dialog Box.....	3-157
Figure 3-21.	Fieldbus Configuration Parameters Dialog Box .....	3-168
Figure 3-22.	Fieldbus Alarms Dialog Box .....	3-169
Figure 3-23.	National Instruments FieldPoint Configuration Parameters Dialog Box .....	3-172
Figure 3-24.	NIDAQ Device Configuration Parameters Dialog Box.....	3-190
Figure 3-25.	NISCXI Definition Parameters Dialog Box .....	3-194
Figure 3-26.	Omron Definition Parameters Dialog Box .....	3-199
Figure 3-27.	OptoHost Definition Parameters Dialog Box: Serial.....	3-204
Figure 3-28.	OptoHostWords Definition Parameters Dialog Box: Ethernet.....	3-206
Figure 3-29.	OptoMistic Parameter Definition Dialog Box. ....	3-214
Figure 3-30.	Optomux Definition Parameters Dialog Box.....	3-218
Figure 3-31.	Philips Configuration Parameters Dialog Box.....	3-224
Figure 3-32.	Profibus DP Configuration Parameters Dialog Box .....	3-232
Figure 3-33.	ProfibusL2 Configuration Parameters Dialog Box.....	3-238
Figure 3-34.	Reliance Definition Parameters Dialog Box.....	3-242
Figure 3-35.	S5_3964 Definition Parameters Dialog Box.....	3-255
Figure 3-36.	S5_AS511 Definition Parameters Dialog Box .....	3-261
Figure 3-37.	SiemensTI505 Definition Dialog Box .....	3-275
Figure 3-38.	Sixnet Configuration Parameters Dialog Box.....	3-283

Figure 3-39.	Tesco Configuration Parameters Dialog Box.....	3-297
Figure 3-40.	Tiway Configuration Parameters Dialog Box .....	3-301
Figure 3-41.	Toshiba M Series Configuration Parameters Dialog Box .....	3-311
Figure 3-42.	Toshiba T Series Configuration Parameters Dialog Box .....	3-311

## Tables

Table 2-1.	Accumulator Data Members .....	2-3
Table 2-2.	Modbus Slave Object Parameter List .....	2-17
Table 2-3.	Alarm Data Members .....	2-26
Table 2-4.	\$Alarm Data Members .....	2-28
Table 2-5.	HOA Modes .....	2-33
Table 2-6.	Alternator Data Members .....	2-34
Table 2-7.	Animator Data Members .....	2-42
Table 2-8.	Average Data Members .....	2-43
Table 2-9.	Counter Data Members .....	2-45
Table 2-10.	DataSocket Data Members .....	2-49
Table 2-11.	Column Names .....	2-63
Table 2-12.	DataTable Data Members .....	2-64
Table 2-13.	DdeLink Data Members .....	2-68
Table 2-14.	DdeTable Data Members.....	2-72
Table 2-15.	DelayOff Data Members .....	2-73
Table 2-16.	DelayOn Data Members .....	2-74
Table 2-17.	Derivative Data Members .....	2-76
Table 2-18.	DialGauge Data Members .....	2-79
Table 2-19.	ElapsedTime Data Members .....	2-81
Table 2-20.	Event Data Members .....	2-82
Table 2-21.	Expression Data Members .....	2-84
Table 2-22.	Flipflop Data Member .....	2-85
Table 2-23.	Gauge Data Members .....	2-87
Table 2-24.	Histogram Data Members .....	2-90
Table 2-25.	HyperTrend Data Members .....	2-99
Table 2-26.	Integral Data Members .....	2-103
Table 2-27.	Interpolate Data Members .....	2-107
Table 2-28.	Interval Data Members .....	2-108
Table 2-29.	Joystick Data Members .....	2-109
Table 2-30.	Junction Data Members.....	2-111
Table 2-31.	\$Keyboard Data Members.....	2-113
Table 2-32.	L3Pot Data Members .....	2-117
Table 2-33.	L3Pushbutton Data Members .....	2-122
Table 2-34.	L3Switch Data Members .....	2-125
Table 2-35.	L3TextEntry Data Members.....	2-127
Table 2-36.	LatchGate Data Members.....	2-128
Table 2-37.	Loader Data Members .....	2-131

Table 2-38.	Mailer Data Members .....	2-136
Table 2-39.	Maximum Data Members .....	2-137
Table 2-40.	Minimum Data Members .....	2-139
Table 2-41.	Monitor Data Members .....	2-141
Table 2-42.	Mouse Data Members .....	2-142
Table 2-43.	Multistate Data Members.....	2-144
Table 2-44.	Neutralzone Data Members .....	2-146
Table 2-45.	Numeric Format Data Members .....	2-147
Table 2-46.	OneShot Data Members .....	2-149
Table 2-47.	Pager Data Members .....	2-152
Table 2-48.	Panel Data Members .....	2-161
Table 2-49.	Pareto Data Members .....	2-168
Table 2-50.	PID Data Members .....	2-174
Table 2-51.	Pipe Data Members.....	2-176
Table 2-52.	Playwave Data Members .....	2-177
Table 2-53.	Pot Data Members.....	2-180
Table 2-54.	Pulse Data Members .....	2-183
Table 2-55.	PushButton Data Members .....	2-188
Table 2-56.	RadioButton Data Members .....	2-193
Table 2-57.	Recipe Data Members .....	2-199
Table 2-58.	Report Data Members .....	2-204
Table 2-59.	Run Data Members .....	2-210
Table 2-60.	Sample Data Members .....	2-211
Table 2-61.	SampleText Data Members.....	2-213
Table 2-62.	Scale Data Members .....	2-215
Table 2-63.	Sequencer Data Members .....	2-218
Table 2-64.	Sort Data Members .....	2-220
Table 2-65.	Spinner Data Members .....	2-222
Table 2-66.	Spreadsheet Data Members.....	2-226
Table 2-67.	SqlExec Data Members .....	2-228
Table 2-68.	Switch Data Members.....	2-236
Table 2-69.	\$System Data Members .....	2-241
Table 2-70.	TextEntry Data Members.....	2-244
Table 2-71.	TimeOfxxx Data Members .....	2-247
Table 2-72.	Trend Data Members .....	2-252
Table 2-73.	Waveform Data Members.....	2-254
Table 2-74.	XBarR Data Members .....	2-259
Table 2-75.	XChart Data Members .....	2-263
Table 2-76.	XYChart Data Members .....	2-267
Table 3-1.	Allen-Bradley DH+ Interface Memory Addresses .....	3-7
Table 3-2.	AB MicroDenotes which display of this object will appear on an HTML report.Logix Data Members.....	3-10
Table 3-3.	AB_PLC2 Data Members .....	3-13

Table 3-4.	AB_SLC500 Data Members .....	3-14
Table 3-5.	AB_PLC5 Data Members .....	3-17
Table 3-6.	AdvantechPCL Data Members .....	3-27
Table 3-7.	Lookout Applicom Object Classes and the Corresponding Protocols/Devices .....	3-29
Table 3-8.	Applicom Local Data Members .....	3-30
Table 3-9.	Applicom JBUS Data Members .....	3-30
Table 3-10.	Applicom April 1000 Data Members .....	3-32
Table 3-11.	Applicom Klockner-Moeller Data Members .....	3-32
Table 3-12.	Applicom Otic Fischer & Porter Data Members .....	3-33
Table 3-13.	Applicom Profibus DP Data Members .....	3-34
Table 3-14.	Applicom Profibus FMS Data Members .....	3-35
Table 3-15.	Applicom Profibus L2 Data Members .....	3-36
Table 3-16.	Applicom Siemens S5 H1 Data Members .....	3-38
Table 3-17.	Applicom SAIA SBus Data Members .....	3-40
Table 3-18.	Applicom Siemens S5 AS511 Data Members .....	3-41
Table 3-19.	Applicom Siemens S7 MPI Data Members .....	3-42
Table 3-20.	Applicom Siemens S7 PPI Data Members .....	3-44
Table 3-21.	Applicom Siemens H1 Data Members .....	3-46
Table 3-22.	Applicom Telemecanique Data Members .....	3-47
Table 3-23.	Aquatrol Data Members .....	3-56
Table 3-24.	ASCII Data Members .....	3-60
Table 3-25.	Data Types Allowed by ASCII .....	3-63
Table 3-26.	Cutler-Hammer Data Member Set .....	3-72
Table 3-27.	DeltaTau Data Members .....	3-76
Table 3-28.	DL205 and DL405 Data Members .....	3-80
Table 3-29.	DNP Data Members .....	3-84
Table 3-30.	Dynamic Data Members .....	3-90
Table 3-31.	Fatek Data Members .....	3-95
Table 3-32.	FisherROC Data Members .....	3-101
Table 3-33.	GE_Series90 Data Members .....	3-108
Table 3-34.	Hitachi Data Members (Address Ranges in Hexadecimal) .....	3-114
Table 3-35.	IPASCII Data Members .....	3-117
Table 3-36.	Data Types Allowed by IPASCII.....	3-120
Table 3-37.	Mitsubishi Data Members (A Series) .....	3-127
Table 3-38.	MitsubishiFX Data Members (FX Series) .....	3-128
Table 3-39.	Mitsubishi CLM Data Members.....	3-132
Table 3-40.	6-Digit Address Coding.....	3-142
Table 3-41.	Modbus Data Members .....	3-142
Table 3-42.	ModbusMOSCAD Data Members .....	3-146
Table 3-43.	Modbus Daniel Data Members.....	3-149
Table 3-44.	Modbus OmniFlow Data Members.....	3-153
Table 3-45.	ModbusSlave Data Members .....	3-157
Table 3-46.	NIDeviceNet Data Members .....	3-164

Table 3-47.	NIDeviceNetExplicit Messaging Data Members.....	3-166
Table 3-48.	National Instruments Fieldbus Data Members .....	3-170
Table 3-49.	National Instruments FieldPoint Data Members .....	3-175
Table 3-50.	Multiple Discrete Data Members .....	3-177
Table 3-51.	FieldPoint TB-10 Module Data Members .....	3-178
Table 3-52.	OPCClient Data Members .....	3-187
Table 3-53.	NIDAQDevice Data Members .....	3-190
Table 3-54.	National Instruments Data Acquisition Devices Supported by Lookout .....	3-192
Table 3-55.	NISCXI Device Data Members .....	3-195
Table 3-56.	Omron Data Members .....	3-201
Table 3-57.	OptoHostWords Data Members .....	3-207
Table 3-58.	OptoMistic Data Members .....	3-215
Table 3-59.	Optomux Data Members .....	3-221
Table 3-60.	Philips Data Members .....	3-226
Table 3-61.	Phoneducer Data Members .....	3-229
Table 3-62.	Profibus DP Data Members .....	3-233
Table 3-63.	ProfibusL2 Data Members .....	3-240
Table 3-64.	Reliance Data Members (all addresses are in octal) .....	3-244
Table 3-65.	RKC Data Member Group .....	3-247
Table 3-66.	Measured Value Group .....	3-248
Table 3-67.	Operation Mode Group .....	3-248
Table 3-68.	Memory Area and Set Value Group .....	3-249
Table 3-69.	Parameter Group 10 (Measured Input Parameters).....	3-249
Table 3-70.	Parameter Group 11 (Remote Setting Input Parameters) .....	3-249
Table 3-71.	Parameter Group 12 (Output Parameters).....	3-250
Table 3-72.	Parameter Group 13 (Auto-Tuning Bias Parameters).....	3-250
Table 3-73.	Parameter Group 14 (Alarm 1 Parameters) .....	3-250
Table 3-74.	Parameter Group 15 (Analog Output Parameters).....	3-251
Table 3-75.	Parameter Group 16 (Positioning, Proportioning, PID Action Parameters) .....	3-251
Table 3-76.	Parameter Group 17 (Bar Graph Parameter).....	3-251
Table 3-77.	Parameter Group 20 (Input Selection Parameters) .....	3-251
Table 3-78.	Parameter Group 21 (Setting Parameters) .....	3-252
Table 3-79.	Parameter Group 22 (Output Action Parameters).....	3-252
Table 3-80.	Parameter Group 23 (Alarm 2 Parameters) .....	3-252
Table 3-81.	Parameter Group 40 (Data Lock Parameters) .....	3-253
Table 3-82.	Lookout Data Members .....	3-253
Table 3-83.	S5_3964 Data Members .....	3-257
Table 3-84.	S5_AS511 Data Members .....	3-262
Table 3-85.	Scan-Data Data Members .....	3-267
Table 3-86.	Siemens S7_HMI Data Members .....	3-272
Table 3-87.	Siemens TI505 Data Members .....	3-278
Table 3-88.	Sixnet Data Members .....	3-285

Table 3-89.	SquareD Data Members .....	3-295
Table 3-90.	Tesco Data Members .....	3-299
Table 3-91.	Tiway Data Members .....	3-306
Table 3-92.	Toshiba M Series Data Members .....	3-313
Table 3-93.	Toshiba T Series Data Members .....	3-314
Table 3-94.	Wizdom Data Members .....	3-317

# About This Manual

---

This manual describes Lookout object classes, listed in alphabetical order, in two chapters.

## Conventions

---

The following conventions appear in this manual:

»

The » symbol leads you through nested menu items and dialog box options to a final action. The sequence **File»Page Setup»Options** directs you to pull down the **File** menu, select the **Page Setup** item, and select **Options** from the last dialog box.



This icon denotes a tip, which alerts you to advisory information.



This icon denotes a note, which alerts you to important information.



This icon denotes a caution, which advises you of precautions to take to avoid injury, data loss, or a system crash.

**bold**

Bold text denotes items that you must select or click on in the software, such as menu items and dialog box options. Bold text also denotes parameter names.

*italic*

Italic text denotes variables, emphasis, a cross reference, or an introduction to a key concept. This font also denotes text that is a placeholder for a word or value that you must supply.

monospace

Text in this font denotes text or characters that you should enter from the keyboard, sections of code, programming examples, and syntax examples. This font is also used for the proper names of disk drives, paths, directories, programs, subprograms, subroutines, device names, functions, operations, variables, filenames and extensions, and code excerpts.

**monospace bold**

Bold text in this font denotes the messages and responses that the computer automatically prints to the screen. This font also emphasizes lines of code that are different from the other examples.

*monospace italic*

Italic text in this font denotes text that is a placeholder for a word or value that you must supply.



## Related Documentation

---

The following documents contain information that you might find helpful as you read this manual:

- *Getting Started With Lookout*
- *Lookout Developer's Manual*
- *Lookout Operator's Manual*
- *Lookout Object Developer's Toolkit Reference*

---

# Introduction to the Lookout Object Class Reference

This manual describes Lookout object classes, listed in alphabetical order, in two chapters.

Chapter 2, *Lookout System Objects*, covers the Lookout System object classes, native to Lookout. You use objects made from these classes as controls and for data analysis and display.

Chapter 3, *Lookout Driver and Protocol Objects*, contains Lookout driver and protocol objects that you use to connect to PLCs, RTUs, and other hardware that is a part of your industrial automation and control system.

Input parameter syntax and data members are documented for each object class, along with a description of the functionality of each object class.



**Note** Lookout assists you in building graphical screen displays when possible. When you place a displayable object (like Pots or Switches) on a control panel, the appropriate **Display Parameter** dialog box appears, prompting you to select a display type. If the object is not displayable but supports an implicit signal (like Counters, LatchGates, and OneShots), Lookout inserts an expression on the control panel.

You can elect not to display an object or its signal by clicking on the **Cancel** button at any time. If you change your mind later, you can display the object or its signal using the **Insert»Displayable Object** or **Insert»Expression** commands, respectively. You can drag and drop an object or data member from the Object Explorer to a panel at any time.

Some object classes have neither a display member nor an implicit signal—instead they have multiple data members. If you want to display the result of a logical or numeric data member on a control panel, you can use the **Insert»Expression** command and choose the appropriate name and data member, or drag and drop the data member from the Lookout Object Explorer.

See the *Getting Started with Lookout* manual for more information on creating objects, modifying their databases, and linking them together.

---

## Lookout System Objects

This chapter describes Lookout System object classes, listed in alphabetical order. Input parameter syntax and data members are documented for each object class, along with a description of the functionality of each object class.

# Accumulator

Accumulator is a numeric totalizer. It samples the numeric **Input** any time the **Sample** value transitions from off to on, adding each new sample to the previous running total. It resets the totalized value to zero when **Reset** transitions from off to on.

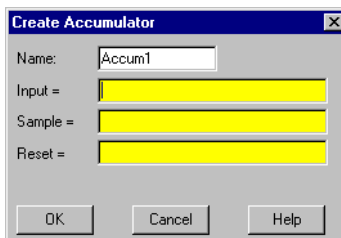

**Figure 2-1.** Accumulator Definition Parameters Dialog Box

**Input** is a numeric expression while **Sample** and **Reset** are logical expressions.

The following HyperTrend demonstrates the relationship between **Input**, **Sample**, and **Reset**.

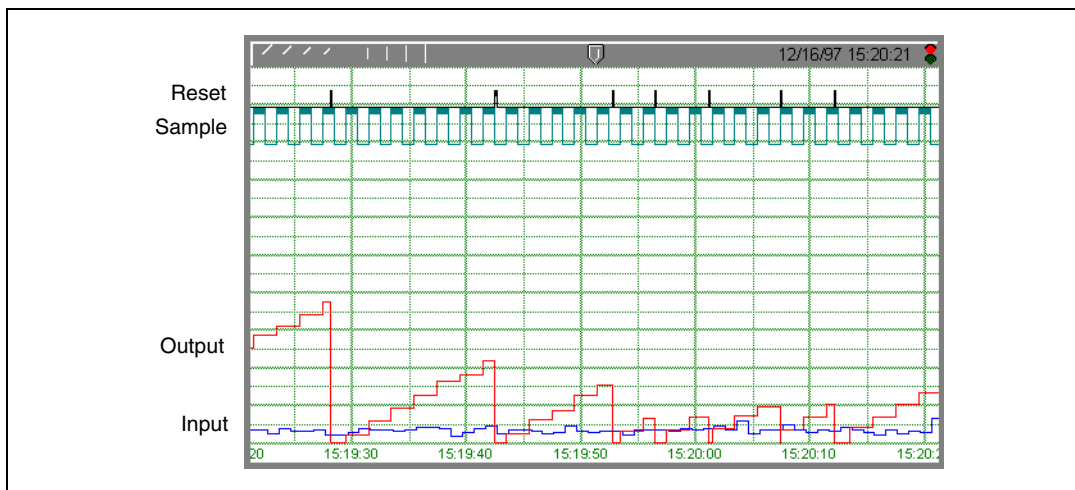

## Accumulator Data Members

**Table 2-1.** Accumulator Data Members

<b>Data Members</b>	<b>Type</b>	<b>Read</b>	<b>Write</b>	<b>Description</b>
(implicit)	numeric	yes	no	Current totalized value, totalized since the most recent Reset signal. Updated at the defined Sample rate.

**Comments** **Reset** could be a regular pulse interval created by a Pulse timer, as shown in the dialog box in Figure 2-1.

The Counter object class totalizes a number of logical events and the Integral object class totalizes rates. Use Accumulator to totalize numeric variables.

**Related Objects** *Average, Minimum, Maximum, Sample*

## ActiveX

---

Use ActiveX controls in Lookout through the ActiveX control object. This means you can use any of a number of widely available programming tools to create your own custom ActiveX control that performs special tasks unique to your needs, and then incorporate that control into your Lookout processes.

While you can use any properly made ActiveX control installed on your computer with the Lookout ActiveX object, Lookout has the following useful National Instruments ActiveX controls, most of which can also be used as indicators.

- **CWButton**—a collection of control panel pushbuttons and switches with special appearance, mode of operation, formatting, and animation options.
- **CWKnob**—a potentiometer type control that can appear as a knob or as several different varieties of a meter, incorporating a wide variety of functionality options.
- **CWMotor**—an on/off control/indicator that can appear on the front panel as several different types of motors, that includes a variety of appearances and function options.
- **CWNumEdit**—numeric entry control with a variety of functionality options and format settings.
- **CWPipe**—an on/off control/indicator that can appear as a variety of pipes on the front panel, that includes a wide variety of appearances and function options.
- **CWPump**—an on/off control/indicator that can appear on the front panel as a variety of pump types, that includes a range of appearance and function options.
- **CWSlide**—a potentiometer type control that can appear as a variety of sliders or as a tank or thermometer, with a wide variety of functionality options.
- **CWValve**—an on/off control/indicator that can appear on the front panel as several different types of valves, with a variety of appearance and function options.

- **CWVessel**—a potentiometer type control that can appear as a variety of tanks, bins, or hoppers, with a wide variety of functionality options
- **CWGraph**—a control in Lookout 4.5 because that is an integral part of the package containing the other controls. It is difficult to use this control in Lookout, so we recommend that you use the HyperTrend or the Lookout graphic objects instead of CWGraph.

The above controls are a part of National Instruments ComponentWorks collection of ActiveX controls. You can acquire other ComponentWorks special use controls separately through National Instruments.

## Creating a Lookout ActiveX Object

Creating an ActiveX object is similar to creating any other Lookout control object. There are a few aspects of creating an ActiveX control that are different, as explained in the following example.

The Lookout *ActiveX object* is an ActiveX container for Lookout that accepts an ActiveX control and allows it to function in a Lookout process, allowing the object to communicate with other Lookout objects and perform its own specific functions, as designed. The *ActiveX control* is a piece of software that meets the Microsoft ActiveX control specifications. It can be anything from a National Instruments ComponentWorks control to a special tool you create to conform to ActiveX standards. ActiveX controls are configured through properties, each control having its own set of properties.

***Lookout 4.5 does not support ActiveX methods and events.***



**Note** Unlike other Lookout objects, you can only have one display for each ActiveX object you create. If you attempt to place a second display on a control panel, Lookout displays an error message instead. This also means you can not <Shift-drag> an ActiveX display to copy it. However, you can <Ctrl-drag> an ActiveX control to make a new instance of it.

Complete the following steps to create an ActiveX object in Lookout.

1. Open the **Select Object Class** dialog box. Click the **ActiveX** tab. The following dialog box appears.

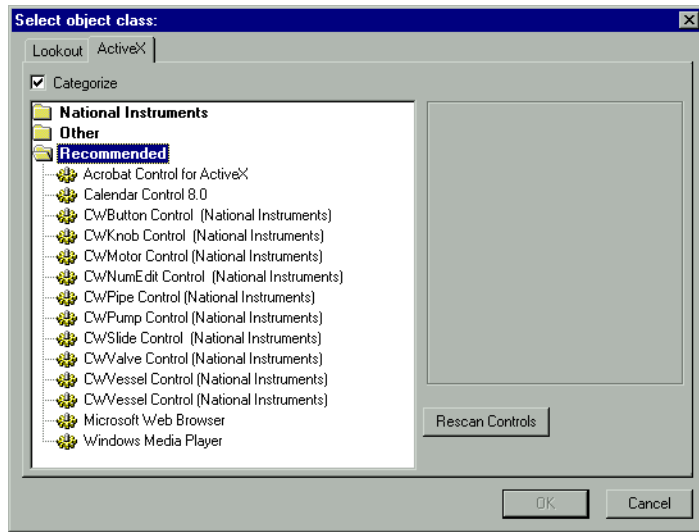

The contents of a complete list of ActiveX controls depends on what ActiveX controls are installed on your computer by various software packages. For example, Microsoft’s Calendar is widely distributed and will usually appear in the list of controls with other controls, including the National Instruments controls installed by Lookout 4.5 and any other National Instruments products.

To help you find the most useful controls for developing a Lookout processes, the ActiveX controls are categorized into three groups:

- **Recommended**—ActiveX controls created by National Instruments or other sources that have been tested with Lookout.
- **National Instruments Controls**—ActiveX controls created by National Instruments that are currently installed on your computer. Lookout may not completely support all of these controls.
- **Others**—ActiveX controls created by someone other than National Instruments that do not appear on the list of controls tested by National Instruments. Lookout may or may not support untested controls.



**Note** If you have recently installed an ActiveX control and it does not appear in the selection list, click the **Rescan Controls** button to look for new ActiveX registrations. If the control you are looking for still does not appear, re-install the control.



2. Select an ActiveX control. This example uses the CWButton control from National Instruments. Click on **OK**. The following dialog box appears.

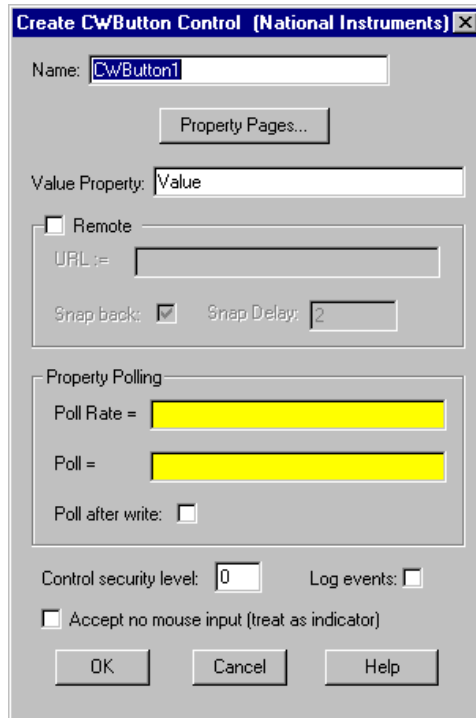

3. Notice that the default object name is a shortened version of the name of the selected ActiveX control with a number appended. Rename it with any name within the Lookout naming conventions.
4. Click the **Property Pages** button to access the dialog box used to configure the ActiveX control, as it will function for this Lookout ActiveX object. Refer to the [ActiveX Control Properties](#) section for more information about working with ActiveX control properties.
5. Check the **Value Property** field. It contains the word `value`. If the field is blank, you are using a custom-built ActiveX control.

Lookout control objects contain a `value` data member that is used when you need to make a connection to a control that has a remote source connection. This data member is also available in an ActiveX object if the ActiveX control has a property we can assign that data member to carry.

When you select which ActiveX control to use in your Lookout ActiveX object, Lookout checks to see if the ActiveX control has a property called `value`. If it does, Lookout makes that property the **Value Property**. If there is no property called `value`, Lookout leaves the **Value Property** field empty.

You can create an ActiveX object without setting a **Value Property**. If you do, then your completed object will not have the `value`, `reset`, or `resetValue` data members, because they will not have any ActiveX control properties to connect to.

In ActiveX terms, this is called the default property. It can be called anything, depending on the control. For ComponentWorks this property is called **Value**.

You can set virtually any property of an ActiveX control as the **Value Property**, but it is best to restrict your selection to properties that are readable, writable, and bindable, and that handle data in a form that you will find useful in your Lookout process.

You cannot browse ActiveX Control properties through the **Value Property** field, so you must know the name for the property you want to select if it is not named `Value`. Refer to the documentation for the ActiveX control you are using to determine the correct property name for the property you want to assign as the **Value Property**.

6. Select **Remote** if you want to make a remote source connection for this ActiveX object. Make the connection as you would with any other Lookout object that permits a remote source connection.
7. Activate **Snap back** if necessary. If you activate **Snap back**, you can then set **Snap Delay**.

Under ordinary circumstances, when a remoted Pot value is changed from a control panel, Lookout allows a given amount of time, in seconds to pass and if the remote value does not change to coincide with the newly selected value, the remoted Pot snaps back to the old value.

For most Lookout control objects, that time is set in the `Lookout.INI` file using the `SnapDelay` key. Because of the nature of ActiveX controls and possible added delay in response time, you can choose whether or not to enable **Snap back** for an ActiveX object, and to set the snap delay for each control (default = 2 seconds). These settings apply only to the ActiveX object in which they were made, and do not override the settings in the `Lookout.INI` file that cover the rest of the Lookout objects.

Refer to Appendix C, *Lookout INI file*, in the *Lookout Developer's Manual* for more information about .INI file setting used for other Lookout control objects.

8. Set **Property Polling**. One of the features of ActiveX control properties is whether or not they are bindable. A bindable property updates automatically, and a non-bindable property control is polled. Which properties are or are not bindable varies between ActiveX controls.

To make sure all the non-bindable properties of the ActiveX control refresh consistently, set a **Poll Rate** to refresh at regular intervals, set a **Poll trigger** (such as a pushbutton or a Lookout expression that polls under predetermined conditions), or select to **Poll after Write** (refreshes the properties after they're written to).

This is only necessary if you are reading the properties in Lookout. Polling is not necessary if you are not reading the values of properties in Lookout or are only reading properties that are bindable and automatically signal Lookout when they change.

9. Select **Accept no mouse input** to disable the user input to the control. This makes the control function as an indicator.
10. Click **OK** to accept the control.
11. Open the Object Explorer if it is not open already, and expand the object. The following figure shows an ActiveX object using the CWButton ActiveX control.

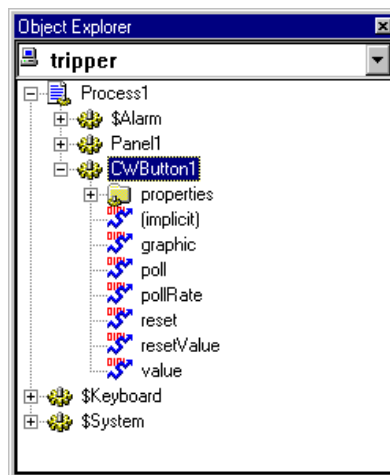

The new object contains data members for the ActiveX object and data members connected to the ActiveX control properties. These ActiveX control property data members are contained in a folder named `properties`. Refer to the ActiveX control documentation for more information about the properties of specific controls.



**Note** Only top-level properties are shown as data members in Lookout 4.5. Sub properties are not shown as data members. If necessary, you can access sub properties from the property pages.

12. Edit the database and make any connections necessary.
13. Configure security and event logging as you would with any other Lookout object. Remember that event logging only takes place for the property you designate as the Value Property when you configure your ActiveX object.



**Caution** Lookout security only works when your ActiveX object is using a windowless ActiveX control. Windowed controls bypass Lookout security. All of the National Instruments ActiveX controls are windowless controls that can be used with Lookout security. Refer to the documentation for any other ActiveX controls you use to see whether they are windowed or windowless controls. For the same reason, snap back is not guaranteed to work properly with windowed controls.

## ActiveX Control Properties

Click the **Property Pages** button in the create object dialog box for an ActiveX object to access the property pages for the ActiveX control you are using with that ActiveX object. A dialog box with many tabs appears, as shown in the following figure.





**Caution** While the National Instruments or ComponentWorks ActiveX control property sheets allow you to alter bindings (like Data Socket), you should consider this an advanced activity and avoid making such changes unless you understand ActiveX controls in general and the particular control you want to change bindings in.

## ActiveX Verbs

Right-click the ActiveX display on the panel to access the ActiveX Verb for that control, as shown in the following figure.

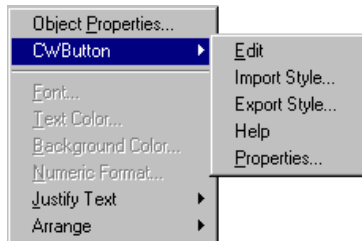

Most often you will be able to get to the property pages from the **Verbs** menu. If the property pages are not available from the verbs menu, select **Object Properties** and click the **Property Pages** button in the ActiveX object dialog box.



**Tip** Detailed documentation for individual National Instruments ActiveX controls is accessible through the **Help** button on the Property pages.

## ActiveX Object Data Members

Data Member	Type	Read	Write	Description
graphic	numeric	yes	no	Data member used to designate which display of this control you want to appear on an HTML report. In the case of the ActiveX object, only one display is available for this purpose.
poll	logical	yes	yes	A transition to true initiates a poll of any properties being read.

poll rate	numeric	yes	yes	Time interval for polling. Enter a time using standard Lookout 00:00:00.0 format.
reset (optional)	logical	yes	yes	While this value equals TRUE, the control will be set to the value in resetValue.
resetValue (optional)	polymorphic	yes	yes	Sets the value a control will take when the reset data member is TRUE.
value (optional)	polymorphic	yes	yes	The current value of the control's value property. If you have removed this control, then value is the current value of the position source.

# Aggregate

---

The Aggregate object is a way for you to create a collection of Lookout objects, already connected and configured, and use that collection multiple times as an element in your processes.

Create an aggregate by creating a Lookout process and saving the process as an *aggregate definition file*, choosing which of the object parameters and data members to expose when aggregate is used in another process. Then use that aggregate definition in other processes by creating an aggregate object that uses your aggregate definition as its source.

If you need to change the aggregate object, you can update the aggregate definition process at any time. The next time you open the process using that aggregate object, any changes to the definition process will be present in the aggregate object.

Follow these useful rules and principles when you use aggregate objects.

- An aggregate object must reference a Lookout process as a definition. When you select the Lookout process file (.14p) as the definition process for your aggregate object, the usual Lookout rules about path and Lookout path relativity apply. In order for your aggregate object to function properly, the aggregate definition process must be present and available in the location the aggregate object references to find it.
- The aggregate definition processes can use both Lookout system objects and Lookout driver and protocol objects.
- You can create multiple aggregate objects in any given single process using the same aggregate definition process.
- You can create nested aggregate objects. You can make an aggregate object using a definition file that itself contains one or more aggregate objects.
- An aggregate object contributes to your Lookout I/O count as the individual elements of the aggregate object definition would if they were incorporated into your Lookout process individually.
- If you change and save the definition process for an aggregate object, the aggregate object will reflect those changes the next time the process containing the aggregate object is loaded and run. This includes any changes you make to individual objects, in connections, and in any definition configuration options you change.

- You can choose which of the data members in an aggregate definition process will be available for use from an Aggregate object. You can expose the data members from your definition process through an aggregate object in several different ways:
  - All data members in the definition process are available through the aggregate object.
  - Only data members read from or written to in the definition process are available through the aggregate object.
  - Individually selected data members from the definition process are available through the aggregate object.
  - No access to any data members in the definition process permitted. In this case the aggregate object usually functions as a display only.
- Most Lookout objects have basic parameters that you configure when you create the object. You can change some of the parameters programmatically and some you can not. Some of these parameters may need to be customized for each different aggregate object you create from a given definition process. You can make object parameters available for configuration in an aggregate object, but special rules apply. Refer to the [Creating an Aggregate Definition Process](#) section for more information about how to prepare a definition process for use in an aggregate object.
- You can use any Lookout process as a definition for an Aggregate object, but if you do so without saving that process as an aggregate definition, you will not be able to take advantage of pre-configuring the aggregate object to make using the object easier and more convenient. For this reason we recommend saving the definition processes as aggregates before using them to create an aggregate object.



**Note** You can create an aggregate object without specifying a definition file or by specifying an invalid file. An object will not function without a valid definition, however. You may find this convenient at certain times in development, debugging, or deployment of your processes, but check to make sure the aggregate object is using a valid definition process file if for some reason it is not working.



## Creating an Aggregate Definition Process

You can use any Lookout process as an aggregate definition. Once you have the process running, save the process as an aggregate definition by selecting **File»Save as Aggregate**. When you save a process as an aggregate definition, you can configure what data members and object parameters will be available for use when you use that definition for an aggregate object.

An aggregate object does not have any display components. However, any panels you create in your aggregate definition process are available through your aggregate object. If you want an aggregate display or displays, use panels when creating the aggregate definition process. You can also create an aggregate definition process with no panel and not have a display.



**Note** You can not drag an object from inside an aggregate to make a display. You can insert an expression or remote a control to an aggregate data member on a panel. You can not use the display element of objects in the aggregate, itself.



**Tip** To make your application using aggregate objects easy to deploy, save all of your aggregate definition processes in a directory inside the `LOOKOUT` directory. Then when you create an Aggregate object, using the **Browse** button to select the Aggregate definition process will automatically make the path relative to the Lookout directory.

When building a definition process, remember that the collection of objects and connections between them in the definition process can *not* be changed through the Aggregate object. What you save is what you will get.

## Object Parameters in an Aggregate Definition Process

Lookout objects have parameters that configure their basic properties. Some parameters can only be set in the create object dialog box. Some parameters accept variables as their input so that you can change the parameters programmatically and some parameters only accept a constant. Most are not accessible through data members. You can expose any object parameter to configure when creating an aggregate object, *but you can not change that configuration programmatically*. This is also true in the case of parameters that ordinarily would accept a variable as an input.

In the case of constant parameters, you may find that some need a different setting in each individual aggregate object use.

For example, you may have a driver that requires a phone number, a serial port setting, or an IP address, to communicate with the device it is supposed to drive. To use this driver in an aggregate, you must be able to change such settings for each object made. The solution is to expose the parameter when saving the process as an aggregate definition.

When creating a definition process, enter the value for the parameter to expose as you would in any other Lookout process, to run and test the process before saving it as an aggregate. When saving the process as an aggregate definition, using the steps in [Saving a Process as an Aggregate Definition](#), you can expose the parameter for use in an aggregate object. The value set for the parameter when the aggregate object is created overrides the setting made in the aggregate definition process.

In the case of parameters that accept either a constant or a variable, there is no problem using a constant when creating the object and exposing the parameter for aggregate use the same way as for a fixed parameter. Use a constant for that parameter when you make an aggregate object using that definition process.

If you need an object parameter to have a variable input in the definition process, connect the appropriate Lookout control to that parameter when creating the object. When you create an aggregate object using that aggregate definition, you can manipulate the variable parameter by connecting to the control from the host process. For example, to adjust the period for a Waveform object, create a Pot object in the definition process, put that control on the panel, and connect it to the **Period** parameter to change the poll rate. Operate the Pot through an Aggregate object by accessing the control panel or programmatically, using the pot's `Value` data member.

## Naming and Numbering Lookout Object Parameters

Lookout object parameters appear with numbers only and not with names. In most cases the numbered parameters correspond to the named options configured in the **Create Object** dialog box, but there are also hidden parameters used for compatibility with earlier versions of Lookout and Lookout objects. Additionally, the number of a parameter does not always correlate with the location of that parameter on the create object dialog box.

Refer to Appendix A, *Object Class Parameters*, to work around this difficulty. The following table is a sample of the parameter list.

**Table 2-2.** Modbus Slave Object Parameter List

Parameter	Name	Type	Description
1	Address	NumCnst	Slave address (1 to 255)
2	Serial port	TxtCnst	Serial port (such as “COM2”)
3	Data rate	NumCnst	Baud rate; default is 9600
4	Parity	TxtCnst	Parity (text); default is “none” (“odd”, “even”, “mark”, “pace”)
5	Data bits	NumCnst	Data bits; default is 8 (not accessible through the create object dialog box)
6	Stop bits	NumCnst	Stop bits; default is 1 (1.5, 2)

The parameter number corresponds to the number of the parameter as it appears in the Connection Browser, and to the order in which parameters appear in a Lookout source file (.lks).

The **Name** is the name of the parameter as it appears in the **Create Object** dialog box for that object. The data type may be logical, numeric, or text, and a constant or a variable. When you expose a parameter that accepts a variable input in an aggregate object, you can only assign a fixed value to it.

Refer to Appendix A, *Object Class Parameters* for a complete description of each parameter.

## Saving a Process as an Aggregate Definition

After finishing the process you intend to use as an aggregate definition, save the process as an aggregate definition. There are potentially two phases of this saving process: exposing data members and exposing object parameters.

### Exposing Data Members in an Aggregate Definition Process

Data members are the most commonly required elements of an aggregate definition process. Complete the following steps to expose Lookout data members when saving a process as an aggregate.

1. Select **File»Save As Aggregate**. The **Define Aggregate Data Members** dialog box appears, as shown in the figure below. This example shows a partially expanded view of the process about to be saved.

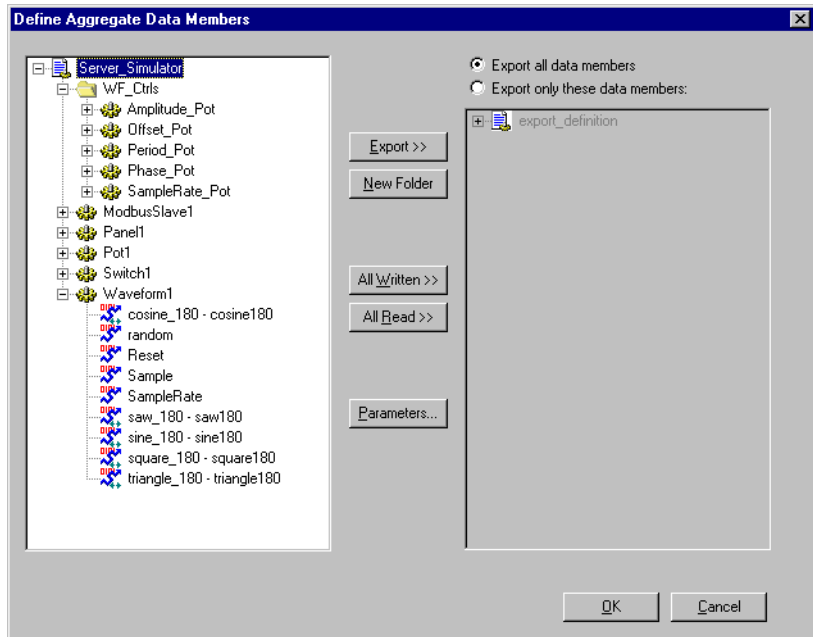

2. Save your process as an aggregate definition with the **Export all data members** option selected, and no individual object parameters exposed, by clicking **OK**. All of the data members belonging to all of the objects in this process will then be available when you create an aggregate object using this as a definition process.



**Note** You can select any file name when you save your process as an aggregate definition. In this way you can keep your original process without any of the aggregate options configured and save variations of the process to use as aggregate definitions in another process. You can also re-save a process you have saved as an aggregate definition under the same or a new file name, changing the data member and parameter configurations.

3. Select **Export only these data members** to limit the data members exposed when you create an aggregate object. When this option is selected, only the data members visible in the right window are exposed when you make an aggregate object from this aggregate definition.

4. Click the **All Written** or **All Read** buttons to expose all the data members being written to or read from in your process. You can remove any unwanted data members manually, if necessary.
5. Delete any unwanted data members by selecting them in the right window and pressing the <Delete> key.
6. Select any unwritten or unread data member in the left window as shown in the following figure, and click the **Export** button to expose the data member in the aggregate.

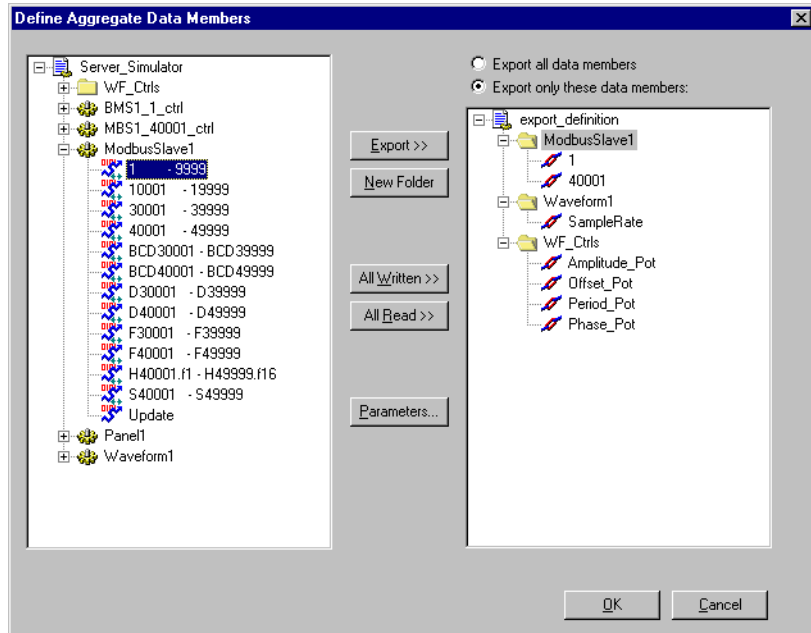

**Note** When you expose an individual data member manually, it appears in the folder that is selected in the right window. Make sure the appropriate folder is selected in the right window before exporting your data member. You can not at this time rearrange data members after they have been exported, but you can delete and re-export them into the location you prefer. If you want to group data members for convenience, create new folders using the **New Folder** button.

7. If the data member representation you select represents a range, the **Select Data Member to Export** dialog box appears, as shown in the following figure.

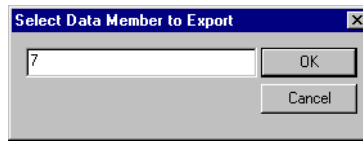

8. Select the data member you want to export from the range and click **OK**.
9. Repeat the process until you have added all the individual data members you want to add.



**Note** Like any other task on a computer, you can lose considerable work if your system crashes or you experience an interruption in power while working. If you are manually exposing a large number of data members in an aggregate definition, save regularly by clicking **OK**. Continue the process of configuring your aggregate definition by selecting **File»Save As Aggregate** and resuming configuration where you left off before saving.

10. If you do not need to expose any object parameters in your aggregate objects, finish saving your process as an aggregate definition by clicking **OK**. If you do need to expose parameters, proceed to the steps in the [Exposing Parameters in an Aggregate Definition Process](#) section below.



**Tip** You can password-protect the Aggregate definition as you can any Lookout process by selecting **Protect file from editing with your account name/password**. Remember that your account must have a password to use this feature. Developers who have an administrator account with no password set will have to set a password for their user account in order to password protect their definition process.

## Exposing Parameters in an Aggregate Definition Process

You may need to expose certain object parameters, such as phone numbers, IP addresses, and COM ports from within aggregate objects. Select the parameters to expose when saving the process as an aggregate definition.

1. After you have exposed the data members you want available and saved the process, if necessary, select parameters to expose by clicking the **Parameters** button in the **Define Aggregate Data Members** dialog box. The **Define Aggregate Parameters** dialog box appears, as shown in the following figure.

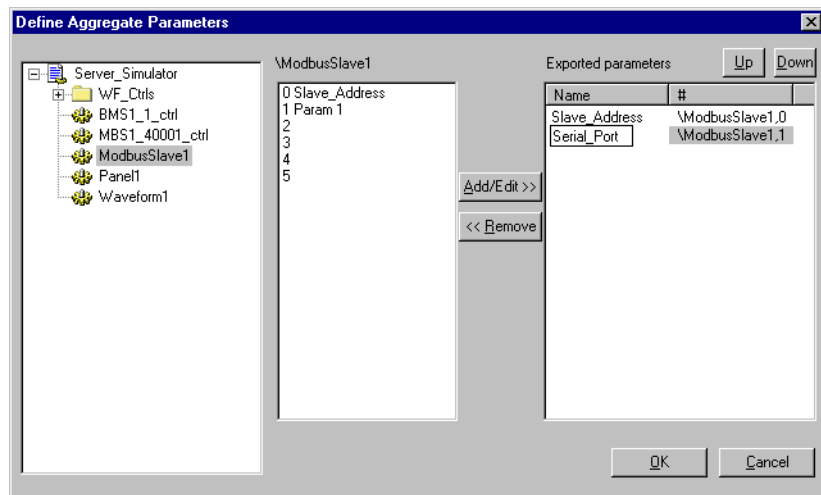

2. Select the object to expose parameters from in the left window of the dialog box. A list of the parameters available appears in the center window.

As discussed in the *Naming and Numbering Lookout Object Parameters* section, the parameters initially appear only as numbers. Assign names to the parameters that will appear when you create an aggregate object later on.

3. Select the parameter you want to expose in your aggregate object in the center window and click the **Add/Edit** button. Enter the name for that parameter in the **Exported Parameters** field. Change the name by selecting it in that field, or by selecting it in the field in the center of the dialog box and clicking **Add/Edit**.
4. Repeat the process until you have exposed all the parameters you need to expose.

5. Click **OK**.
6. This returns you to the **Define Aggregate Data Members** dialog box. If there are no other data members to export, complete saving your process as an aggregate definition by clicking **OK**.

## Creating and Configuring an Aggregate Object

Once you have saved a process to be used as a definition process, you can create multiple aggregate objects from that definition. To create an aggregate object, use the following instructions.

1. Select **Object»Create** from the Lookout menu or right-click in the Object Explorer on the process you want to put an aggregate object in, select **New Object**, then select **Aggregate** from the list of object classes. If you have your selection list categorized, you will find the aggregate in the **Control** category. The **Create Aggregate** dialog box appears, as shown in the following figure.

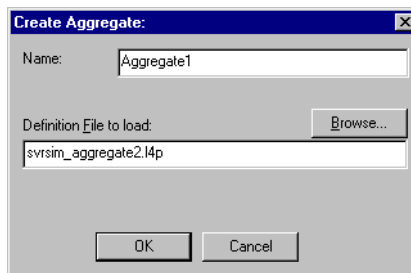

2. The aggregate has only one parameter of its own: the definition process to use. Enter the name of the file for the Lookout process saved as an aggregate in previous steps. Click the **Browse** button to locate the file.



**Note** You must have the .i4p file for the definition process available for an aggregate object to work. Store this file in the `Lookout` directory and access the file using a relative path. If necessary you can make multiple copies of the definition process file if you have host processes running from different directories on your computer. However, using a path within the `Lookout` directory when you create an aggregate object is a better strategy.



- Once you have set the path to the definition process, click **OK**. If you did not expose any parameters when you saved the definition process as an aggregate, this completes the task of creating an aggregate object. If you have exposed parameters to configure, the **Assign Parameter Values** dialog box appears, as shown in the following figure.

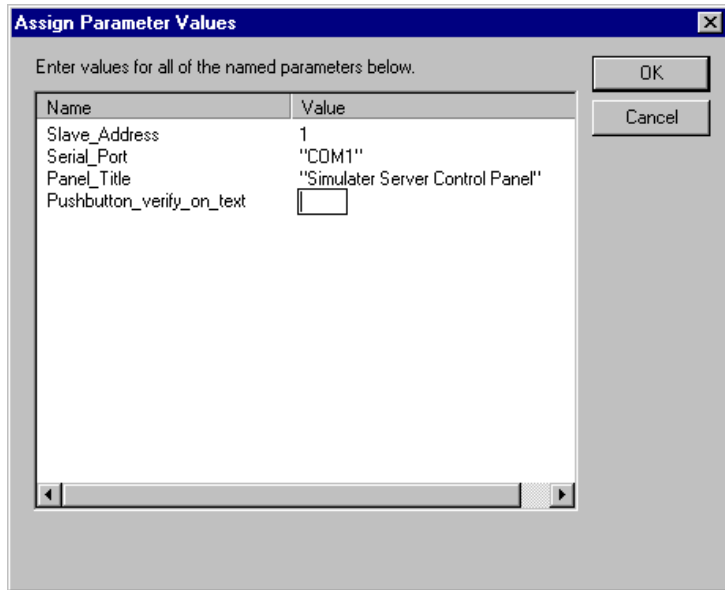

- The parameters configured to be available in the aggregate object when you saved the definition process are listed at the left side of the field. Click anywhere on a line to enter the value for the parameter that is on that line.  
  
The allowable values for the parameters are documented in Appendix A, *Object Class Parameters*.
- When you finish entering the values for the parameters, click **OK** to complete the creation of the Aggregate object.

## Making Connections and Editing the Database for Aggregate Objects

Make connections to the exposed data members and configure them in the database as you would with any other Lookout object.

# Alarm

Alarm is a flexible and powerful object class you use to create various logical- and numeric-triggered alarms that are displayed in the alarm window.



**Note** You should first read about the Lookout alarm system in Chapter 9, *Alarms and Events*, in the *Lookout Developer's Manual* to aid you in designing the most efficient alarming scheme for your application.

The screenshot shows the 'Create Alarm' dialog box with the following settings:

- Name: LogicalAlarm
- Alarm\_area: Plant
- Message: "Relief valve failed to open after 30 seconds"
- Condition: PLC1.reliefVlv AND DelayOnTimer
- Logical alarm (selected)
- Priority (1-10): 8
- Wave file: c:\
- Numeric alarm (unselected)
- Buttons: OK, Cancel, Help

**Figure 2-2.** Typical Settings for a Logical Style Alarm

There are two basic alarm types: Logical and Numeric. **When Logical alarm** is selected, Lookout prompts you to enter a logical expression in the **Condition** field. It then uses the logical **Condition** to trigger and reset the alarm. If the alarm **Condition** is true, the alarm is active, and if the condition is false, the alarm goes inactive. You can also connect an audio **Wave file** to individual logical alarms. Refer to the [Playwave](#) section for more information about using audio Wave files in Lookout.

Lookout queues alarm .wav files, with up to 100 files in the queue. Each alarm .wav file plays completely before the next file plays. If more than 100 alarms fill the queue, new alarms cancel the currently playing files and begin playing instead.

When you pick the **Numeric** alarm selection, the name of the Condition field changes to **Signal**. This prompts you to enter a numeric expression in the field against which your various alarm setpoints are measured. **Hi-Hi**, **Hi**, **Lo**, and **Lo-Lo** are all numeric expressions. **Rate of change** generates an alarm when the signal is actively changing by the set amount for the period of time between any two **Sample** pulses. The **Unit time** setting determines the time units for the rate of change.

The screenshot shows the 'Create Alarm' dialog box with the following settings:

- Name:** Alarm1
- Alarm area:** (empty)
- Message =** (empty)
- Signal =** (empty)
- Logical alarm:** (unchecked)
- Numeric alarm:** (checked)
  - Priority (1-10):** 4
  - Wave file:** (empty)
  - Hi-Hi level =** HiHiSetpoint
  - Hi level =** (empty)
  - Lo level =** (empty)
  - Lo-Lo level =** LoLoSetpoint
  - Rate of change =** 2.5
  - Unit time:** 00:01:00.0 (Example: 1:00 for per minute)
  - Sample =** Pulse (true, 0.0:1.0, 0.0)

**Figure 2-3.** Typical Settings for a Numeric Style Alarm

**Alarm area** specifies the group name associated with the alarm object. All previously defined groups appear in the list box and may be selected with the mouse.

**Priority** ranges from 1 to 10 where 10 is the most important.

**Message** is a text expression whose result is displayed in the alarm window when this object generates an alarm. If alarm style is numeric, the relevant alarm trigger prefixes your message (for example, HiHi level: *Alarm message*). Refer to Chapter 9, *Alarms and Events*, in the *Lookout Developer's Manual* for more information about alarms.

## Alarm Data Members

**Table 2-3.** Alarm Data Members

Data Members	Type	Read	Write	Description
active	logical	yes	no	Result of logical alarm status. True if alarm is active and false if alarm is inactive.
hi	logical	yes	no	Result of numeric alarm hi data member status.
hihi	logical	yes	no	Result of numeric alarm hihi data member status.
lo	logical	yes	no	Result of numeric alarm lo data member status.
lolo	logical	yes	no	Result of numeric alarm lolo data member status.
rate	logical	yes	no	Result of numeric alarm rate data member status.

**Comments** A common alarm condition is caused by a measured value going out of an acceptable range. For example, a storage tank whose level is too low or too high can generate several alarms: Hihi: Tank level is out of range, or Lo: Tank level is out of range. If you use a numeric style alarm to trigger the alarm and if the tank level fluctuates or “jitters” around the alarm level settings, a new alarm record is generated in the alarm window each time the tank level fluctuates above or below the level settings. To alleviate this condition, you could use the Neutralzone object to filter out minor tank fluctuations.



**Note** Alarms can also be defined through parameter settings on object data members. Many times, this is the most efficient method of defining and creating alarm conditions. Refer to the *Database-Generated Alarms* section of Chapter 9, *Alarms and Events*, in the *Lookout Developer’s Manual*, and the *Editing Object Databases* section of Chapter 4, *Using Lookout*, in the *Getting Started with Lookout* manual for more information about creating alarm conditions..

# \$Alarm

\$Alarm is a global object. It makes available global alarm data such as the number of currently active alarms.

You can use \$Alarm data members just like other data members. By inserting an expression you can display the number of active alarms in any particular group. Or, by connecting a pushbutton to an acknowledge data member, operators can acknowledge alarms through pushbutton selection.

Assume, for example, that you want to create a pushbutton that acknowledges all alarms. First create a pushbutton object. Next, use the **Object»Edit Connections** command to connect the pushbutton (Pb1) to the .ack data member of \$Alarm. Such a connection is shown in the following illustration.

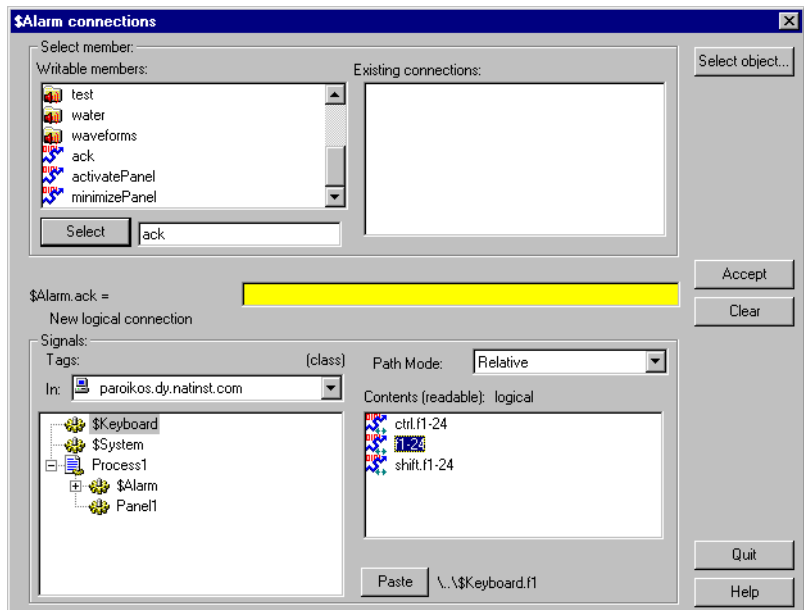

**Figure 2-4.** Edit Connections Dialog Box for using \$Alarm

The expression (Pb1) acknowledges all active alarms any time the pushbutton is depressed. You could make similar connections to acknowledge individual alarm areas.

You can define new alarm areas through Alarm objects and by modifying object database parameters. As you create each new alarm area, Lookout adds new readable and writable data members to the \$Alarm object. \$Alarm data members are described in the following table.

## \$Alarm Data Members

**Table 2-4.** \$Alarm Data Members

<b>Data Member</b>	<b>Type</b>	<b>Read</b>	<b>Write</b>	<b>Description</b>
ack	logical	no	yes	Upon transition from FALSE to TRUE, acknowledges all alarms.
Ackselected	logical	no	yes	Upon transition from FALSE to TRUE, acknowledges all selected alarms.
ActivatePanel	logical	no	yes	Calls Alarm Window upon transition from FALSE to TRUE, making it visible on the screen.
Active	numeric	yes	no	Total number of currently active alarms (that is, alarm conditions that still exist).
Groupname	text	yes	no	Alarm area name associated with the most recent alarm.
<i>Groupname.ack</i>	logical	no	yes	Upon transition from FALSE to TRUE, acknowledges all alarms within the specified group.
<i>Groupname.active</i>	numeric	yes	no	Number of currently active alarms within the specified group.
<i>Groupname.unacked</i>	numeric	yes	no	Number of unacknowledged alarms within the specified group.
Message	text	yes	no	Text of the message of the most recent alarm.
MinimizePanel	logical	no	yes	Closes Alarm Window upon transition from FALSE to TRUE, changing it to an icon.
Priority	numeric	yes	no	Alarm priority associated with the most recent alarm.

**Table 2-4.** \$Alarm Data Members (Continued)

<b>Data Member</b>	<b>Type</b>	<b>Read</b>	<b>Write</b>	<b>Description</b>
Priority01.active – Priority10.active	numeric	yes	no	Number of currently active alarms of the specified priority.
Priority01.unacked – Priority10.unacked	numeric	yes	no	Number of unacknowledged alarms of the specified priority.
Silence	logical	no	yes	Turns off alarm sounds when set to TRUE.
Name	text	yes	no	Object name associated with the most recent alarm.
Unacked	numeric	yes	no	Total number of unacknowledged alarms (that is, alarm conditions that have not yet been acknowledged).
Update	logical	yes	no	Pulses high every time there is a new alarm.

**Comments** Groupname in the preceding table represents the name of any specified alarm area. The \$Alarm object contains an .active, .unacked, and .ack data member for every alarm area.

## Using \$Alarm with Other Objects

Every time a new alarm appears in Lookout, \$Alarm.Message, \$Alarm.Name, \$Alarm.Groupname, and \$Alarm.Priority are updated with the appropriate information for the new alarm. Then \$Alarm.Update pulses high to alert you that those four data members contain fresh values.

These data members can serve many purposes, but they are specifically designed to work with the Pager object class. In a typical application, you could use \$Alarm.Update to initiate a page, possibly including the other four data members in the text of the page. With this system you can also filter which alarms you want to page, and which alarms the pager ignores.

# Alternator

Alternator is an object class Lookout uses to control a series of devices with various commands. Typically this means rotating the usage of the devices at specified times.

You configure the Alternator using the parameters in the **New Alternator** dialog box. You use the Alternator with the data members, as discussed in the Using the Alternator section.

Operating Mode determines the way an Alternator object orders devices for use. Select **Least Recently Used** to have Lookout select the device which has been off the longest as the device to start next. Select **Sequential** to use the devices in their connection order. Use sequential mode if you want to mimic the behavior of traditional hardware alternators. Select **Total Run Time** to use devices in order of their total time of use (using the ElapsedTime data member). The Alternator will use the device with the least total run time as the next to be started.

**Devices** determines the maximum number of devices that can be controlled by the Alternator.

**Maximum run time** is the maximum amount of time that any one device is allowed to run continuously. This function can be disabled by entering 0.



**Delay between device** starts is the minimum amount of time between device starts that are initiated by the Alternator object. This function can be disabled by entering 0.

**Device failure alarm priority** determines the priority level of alarms generated by the Alternator. This defaults to 5.

**Device response time** is the amount of time the Alternator waits for a response from a device before activating an alarm. This function can be disabled for individual devices by not connecting anything to the Response data member.

**Device name** is a string describing the type of device that is being controlled by the Alternator. This is used to create the alarm messages and is also the name of the group to which the alarms belong.

**Timer update** specifies the resolution of the timers used by the Alternator to decide which devices to turn on and off. This also specifies how often the Alternator updates the ElapsedTime and RunTime data members.

When a device fails, Lookout removes that device from the sequence. Check **Retry Device after Alarm Condition** to have Lookout keep trying the device even when an alarm is active for that device. Deselecting this option keeps the device from coming on, even after it has been replaced or repaired. To get the device back on line, set the HOA option to Auto. (If the HOA setting is already on Auto, you can move the HOA control off Auto and then return it.)

## Using the Alternator

You configure the Alternator with the parameters in the **New Alternator** dialog box. You use the Alternator with the data members, as discussed in the following sections.

## Connecting the Alternator

Connect the DeviceRequest data members to the drivers controlling your devices. Notice that when you connect the DeviceRequest data member to anything, the DeviceConnect data member goes high. This connection is the only one required for the Alternator to consider your device connected. The RunTime, ElapsedTime, DeviceConnect, and DeviceOn data members can be connected to or not connected, depending on whether you want that information.

The Command data member is the essential writable data member to connect to. The connection to Command can be any numeric expression, but a RadioButton or a Pot object is probably most convenient, especially for testing and demonstration purposes. Command only accepts values in the integer range from zero to the number of device connections specified as a parameter.

Connect the Response data members to a response bit from each device. If no connection is made to Response, the Alternator does not require any response from the device.

You do not have to make connection to the Advance, Reset, and HOAmode data members unless you want their functionality. Advance and Reset typically are connected to Pushbuttons, and HOAmode typically connects to a RadioButton or a Pot object. The HOAmode data member only accepts values in the integer range from one to three. Refer to the [Hand-Off-Auto Modes](#) section for more information about this data member.

## Command and Advance

The Command data member determines the number of devices that the Alternator is to have running at one time. When you send the Alternator its first command, it requests a corresponding number of devices to turn on. The DeviceRequest data member for each of these devices goes high to signify this. When the devices respond that they are in fact on (through the Response data member, if it is connected) the Alternator recognizes that the device is on and the DeviceOn data member goes high.

Conversely, if the Command data member specifies that devices are to be turned off, the DeviceRequest data members for the corresponding number of devices goes low. The devices should then respond accordingly using the Response data member.

When you give the Alternator a numeric command, it takes into account the number of devices currently running, and makes its requests accordingly. Because of this, it is important to know how the Alternator counts the number of devices running. Devices running as a result of a Hand command from the HOAmode data member are not counted. All other running devices (including those with active alarms) are counted.

When the Alternator is asked to turn on a new device, it chooses the device according to the rules of the operating mode you selected in the New Alternator dialog box.

The Advance command turns on one device and turns off another device.

## Maximum Run Time and Delay Operation

The Maximum run time parameter specifies how long any one device can be running. Each device has its own timer to ensure that this is enforced. When one of these timers informs the Alternator that its device has been on for the maximum allowed time, the Alternator executes a command identical to the Advance command. Notice that there are two cases where the maximum time limit is not enforced strictly. One of them is when you have turned on a device via the HOAmode data member. The other is when it conflicts with the operation of the Delay between device starts feature.

Delay between device starts is specified as a parameter, and limits how often the Alternator can turn on devices. An example of the operation of the Delay between device starts would be beginning with a new Alternator that has none of the devices on. You issue a command using the Command data member of 3. If the delay feature is in use, the Alternator sends three ON requests separated by the amount of time specified by Delay between device starts.

## Hand-Off-Auto Modes

The HOAmode data member gives you direct control over each device.

When the HOAmode data member is in Auto mode (as it is by default if you never connect anything to this data member) the device is subject to the commands of the Alternator. Its DeviceConnect data member will be high to signify that the Alternator recognizes it.

In Hand mode, the device is disconnected from the Alternator and is sent an on request. So Hand mode is essentially an on state. In Off mode the device is disconnected and requested off. In these two modes, the Alternator does not recognize or request anything of these devices. If you select Auto mode again, the device is reconnected to the Alternator, and operates as determined by the Alternator.

The integer value of this numeric data member corresponds to an operating mode as shown in the following table

**Table 2-5.** HOA Modes

HOA Mode	Integer
Hand	1
Off	2
Auto	3

## Elapsed Time, Run Time, and Reset

The ElapsedTime data member keeps track of how long a particular device has been on since its last reset (or since it was created). As with most Lookout measurements of time, the value of this data member is expressed in days. Right-click on any display of this data and select Numeric format to choose a convenient time scale format for display.

The RunTime data member keeps track of how long a particular device has been on continuously. As with most Lookout measurements of time, the value of this data member is expressed in days. Right-click on any display of this data and select Numeric format to choose a convenient time scale format for display.

The Reset data member is used to reset ElapsedTime.

## Alternator Data Members

**Table 2-6.** Alternator Data Members

Data Member	Type	Read	Write	Description
Advance	logical	no	yes	Turns on the next device in the sequence and turns off the last device in the sequence.
Command	numeric	no	yes	Specifies how many devices the Alternator is to have running.
DeviceConnect1 - DeviceConnect100	logical	yes	no	States whether device is in the active sequence considered by the Alternator.
DeviceOn1 - DeviceOn100	logical	yes	no	Confirmation of the actual device state.
DeviceRequest1 - DeviceRequest100	logical	yes	no	Output to whatever drives the device.

**Table 2-6.** Alternator Data Members

<b>Data Member</b>	<b>Type</b>	<b>Read</b>	<b>Write</b>	<b>Description</b>
DeviceStatus 1 - DeviceStatus100	numeric	yes	no	(Sequential mode only.) Returns the priority of the indicated device in your Alternator sequence.  While you can connect to this data member in any Alternator mode, this data member is only meaningful when used in sequential mode.
ElapsedTime1 - ElapsedTime100	numeric	yes	no	Elapsed time device has been on since last reset.
HOAmode1 - HOAmode100	numeric	no	yes	States whether device is in Hand, Off, or Auto mode (returns number value for Pot object or RadioButton).
Lag1 - Lag99	numeric	yes	no	(Sequential mode only.) Numbers the devices beginning with the first device to be switched on after the after the LeadSelect device is turned on. Lag1 is the first device to be turned on in a sequence based on the current state of the devices.  While you can connect to this data member in any Alternator mode, this data member is only meaningful when used in sequential mode.

**Table 2-6.** Alternator Data Members

<b>Data Member</b>	<b>Type</b>	<b>Read</b>	<b>Write</b>	<b>Description</b>
LeadSheet	numeric	yes	yes	(Sequential mode only.) Specifies the start of the sequence. This is a 1 based data member. When set to 0, LeadSelect has no effect.  While you can connect to this data member in any Alternator mode, this data member is only meaningful when used in sequential mode.
Reset1 - Reset100	logical	no	yes	Used to reset the ElapsedTime data member.
Response1 - Response100	logical	no	yes	Response bit from device.
RunTime1 - RunTime100	numeric	yes	no	Elapsed time device has been on continuously.

## Alternator Status Messages

### Not responding to on request

A device that was sent an ON request via the DeviceRequest data member did not respond that it had in fact turned on. How the Alternator responds to this condition depends on the setting you choose for the Retry Device after Alarm Condition parameter in the New Alternator dialog box. If you enable that option, the Alternator attempts to turn the device in question on when its turn comes, and the alarm remains active until the device responds properly to an Alternator command.

If you disable this option, the Alternator will not attempt to turn the device on until you change the HOA setting to Auto, or cycle the HOA setting from Auto to another setting and then back to Auto.

### Not responding to off request

A device that was sent an OFF request via the DeviceRequest data member did not respond that it had in fact turned off. How the Alternator responds to this condition depends on the setting you choose for the Retry Device after Alarm Condition parameter in the New Alternator dialog box. If you enable that option, the Alternator attempts to turn the device in question on

when its turn comes, and the alarm remains active until the device responds properly to an Alternator command.

If you disable this option, the Alternator will not attempt to turn the device on until you change the HOA setting to Auto, or cycle the HOA setting from Auto to another setting and then back to Auto.

### **Turned on unexpectedly**

A device that was previously off and that the Alternator expected to remain off turned on without reason. How the Alternator responds to this condition depends on the setting you choose for the Retry Device after Alarm Condition parameter in the New Alternator dialog box. If you enable that option, the Alternator attempts to turn the device in question on when its turn comes, and the alarm remains active until the device responds properly to an Alternator command.

If you disable this option, the Alternator will not attempt to turn the device on until you change the HOA setting to Auto, or cycle the HOA setting from Auto to another setting and then back to Auto.

### **Turned off unexpectedly**

A device that was previously on and that the Alternator expected to remain on turned off without reason. How the Alternator responds to this condition depends on the setting you choose for the Retry Device after Alarm Condition parameter in the New Alternator dialog box. If you enable that option, the Alternator attempts to turn the device in question on when its turn comes, and the alarm remains active until the device responds properly to an Alternator command.

If you disable this option, the Alternator will not attempt to turn the device on until you change the HOA setting to Auto, or cycle the HOA setting from Auto to another setting and then back to Auto.

### **Not responding to HOA command**

A device did not respond properly to a command from the HOA mode data member. How the Alternator responds to this condition depends on the setting you choose for the Retry Device after Alarm Condition parameter in the New Alternator dialog box. If you enable that option, the Alternator attempts to turn the device in question on when its turn comes, and the alarm remains active until the device responds properly to an Alternator command.

If you disable this option, the Alternator will not attempt to turn the device on until you change the HOA setting to Auto, or cycle the HOA setting from Auto to another setting and then back to Auto.

# Animator

The Animator object class provides full graphical animation including horizontal and vertical motion, dynamic resizing and visibility, dynamic symbol sequencing and programmable color changes.

When you first create an animator object, the **Select graphic** dialog box appears.

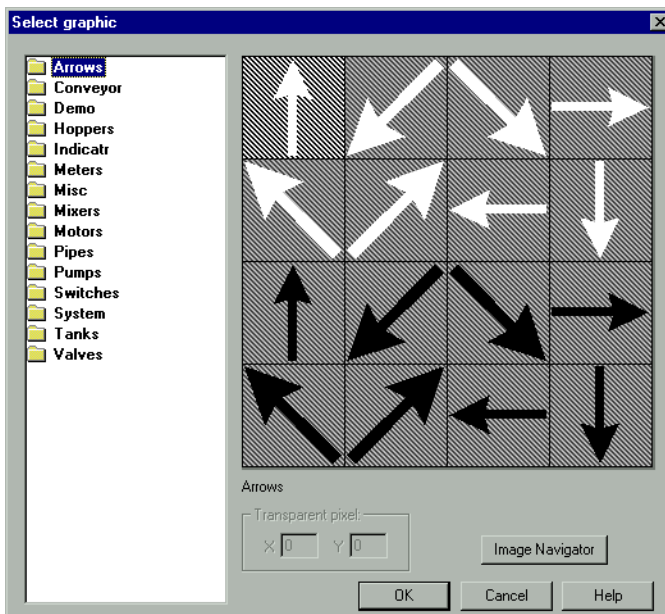

**Figure 2-5.** Select Graphic Dialog Box

Select the graphic you want to animate. To animate colors, you must select a Windows Metafile (.wmf). A moving animation must have the series of images you want to animate arranged in a single bitmap so that each cell of the animation can be defined by a grid of rows and columns.



## Animations

To create a moving animation, select the Animation name.

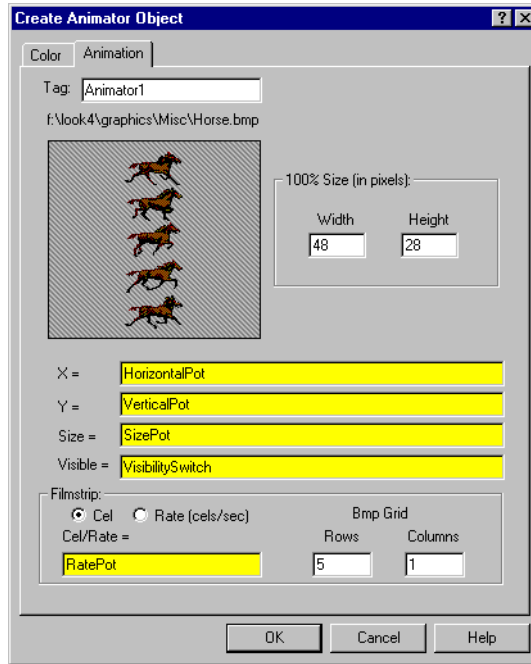

**Figure 2-6.** Animator Definition Parameters Dialog Box, Animation Tab

The graphic file you select determines what images appear on the screen. You delineate the images in a bitmap graphic by dividing it into a grid of **Rows** and **Columns**. In the preceding illustration, the single column is 48 pixels **Wide** and each row is 28 pixels **High**. Conceivably, the grid *could* consist of 32,000 cells. 100 cells would be more practical.

Each grid cell is a filmstrip image. Internally, the Animator assigns a cell number to each image. It normally plays the filmstrip by progressing from left to right and top to bottom, from the lowest cell number to the highest cell number.

The **Rate (cells/sec)** selection you use to specify a frequency at which the Animator progresses from one cell image to the next. The rate value can be positive or negative and can range from 0.0000005 (one frame every 23.148 days) to 100 frames per second.

If the rate value is negative, the Animator plays the filmstrip backwards, starting at the last cell.

You can use the **Cell** selection in the definition dialog box to identify a particular cell number to display. For example, you might use this selection to display a specific image when a PLC register is equal to a particular value. This is similar to the multistate object, but can provide many more states, depending on the number of cells in the bitmap.

The **X** and **Y** parameters specify the horizontal and vertical position of the image, respectively. These numeric parameters range from 0 to 100, and together provide the X-Y position of the image as a percent of the Animator dimension on a control panel.

**Size** is a numeric parameter that ranges from 0 to 100 percent, where 100 percent is the full size of a single cell as specified by **W** and **H**.

**Visible** is a logical parameter that causes the image to appear when it goes true and disappear when it goes false.

## Color Animation

To create color changes programmatically, select the **Color** tab.

With this option, you can set the color map on a `.wmf` graphic using a series of five logical conditions and a default state. If no condition is true, the default state (or color map) is imposed.

You can choose a custom color map by clicking on the color sample associated with each logical condition. You can then select any color from the palette available on your computer.

Select the **Show Original Colors** box if you want the original color map of the .wmf file to be imposed for that condition.

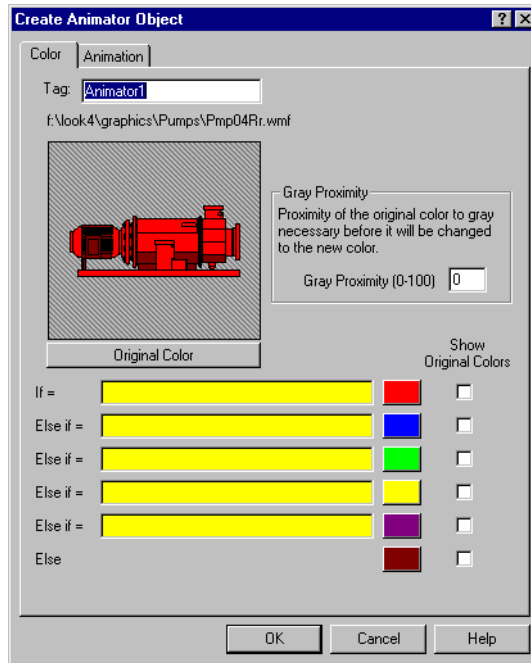

**Figure 2-7.** Animator Definition Parameters Dialog Box, Color Tab

**Gray Proximity** determines the color saturation point at which the selected color replaces an original color. When this parameter is set to 0, most colors change. When this parameter is set to 100, most colors will not change. You can test the effects of this setting by putting your cursor over the color button and observing the change in the graphic displayed in the dialog box window.

Notice that the if and else if statements are evaluated in sequence. If several conditional expressions are true at once, Multistate displays the graphic associated with the first true expression.

For instance, if your **If** parameters use less-than comparisons, such as `PumpSpeed<50`, the following **Else if** parameter must have a larger comparison value, such as `PumpSpeed<75`. If you use a smaller comparison value, such as `PumpSpeed<25`, the color change will not take place. In other words, the comparison values must be used from smallest to largest.

In the same way, if you are using greater-than comparisons, such as `PumpSpeed>50`, you must list your comparison values from largest to smallest, so that the next **Else If** parameter would have to be something like `PumpSpeed>25`.

Put **If** parameters using equality, such as `PumpSpeed=50`, before parameters using inequalities.

A few minutes experimentation should help you understand the interactions of the color choice conditions.

## Animator Data Members

**Table 2-7.** Animator Data Members

Data Member	Type	Read	Write	Description
none	—	—	—	Animator objects do not have data members
graphic1-graphicN	numeric	yes	no	Denotes which display of this object will appear on an HTML report. Only one display is available for the ActiveX object.

**Comments** Consider using an Integral object instead of a Counter/Pulse combination when trying to achieve smooth animation.

**Related Objects** *DialGauge, Gauge, Multistate, Pipe, Spinner*

# Average

Average actively calculates the average value of **Data** over time. Average is only active when the **Enable** expression is true and resets to zero when the **Reset** expression transitions from off to on. Average also maintains an array of up to 35 previous averaged values. If **Enable** is left blank, the object always actively calculates the average.

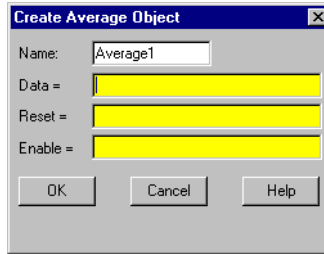

**Figure 2-8.** Average Definition Parameters Dialog Box

**Data** is a numeric expression while **Reset** and **Enable** are logical expressions.

## Average Data Members

**Table 2-8.** Average Data Members

Data Members	Type	Read	Write	Description
(implicit)	numeric	yes	no	Current average calculated since the most recent Reset signal. Updated approximately once per second.
1 – 35	numeric	yes	no	Previous average values. Signal 1 is the most recent prior average since the Reset signal went high.
DataReset	logical	no	yes	Upon transition from FALSE to TRUE, resets to zero all data members—including the current average and all previous averages.

**Comments** The **Reset** expression could be a regular pulse interval created by a TimeOfxxxx timer, so that the pulse is synchronized to the top of the hour or day. For example, if you want to calculate the daily average flow rate, use the output signal from a TimeOfDay timer or a daily Spreadsheet object to reset the average calculation at the beginning of each day. If you want to calculate the average flow rate only when a pump is running, use the input signal from the pump motor relay in the **Enable** parameter.

**Related Objects** [Minimum](#), [Maximum](#), [Sample](#)

# Counter

Counter counts the number of times that the **Count** expression transitions from off to on. The digital display shows the number of pulses counted so far, and is updated approximately once per second—however, it can receive and count multiple pulses within a given second. The counter can count to just under 4,503,600,000,000 or 142,710 years worth of pulses at one pulse per second. When the **Reset** expression transitions from off to on, the counter resets to zero.

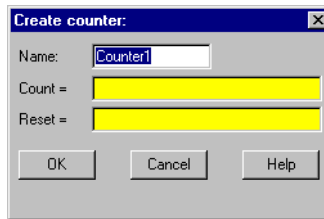

**Figure 2-9.** Counter Definition Parameters Dialog Box

Both **Count** and **Reset** are logical expressions.

## Counter Data Members

**Table 2-9.** Counter Data Members

Data Member	Type	Read	Write	Description
(implicit)	numeric	yes	no	numeric total of pulse count

**Comments** You should not use Counters to count external pulse signals that cycle more often than about once per second. For higher counting speeds, use the accumulator capabilities built into your PLC.

**Related Objects** [Accumulator](#), [Integral](#)

# DataSocket

The DataSocket is a National Instruments method of transferring data between different software applications. Use the Lookout DataSocket object as a DataSocket client to connect to any DataSocket server running on a computer accessible on your network.

You must create a separate DataSocket object for each DataSocket server item you intend to access. Unlike most Lookout objects the DataSocket can read from and write to DataSocket server arrays using a special syntax in the data members. Refer to the [Accessing DataSocket Arrays](#) section for more information about this feature of the object.



**Note** You must connect to an active DataSocket server for the DataSocket object to work. Because of its ability to communicate over a network, Lookout does not ship with a DataSocket server. You can use the DataSocket object to access data from LabVIEW, BridgeVIEW, Measurement Studio, or other National Instruments applications running on your network, especially if those applications are using data in arrays.

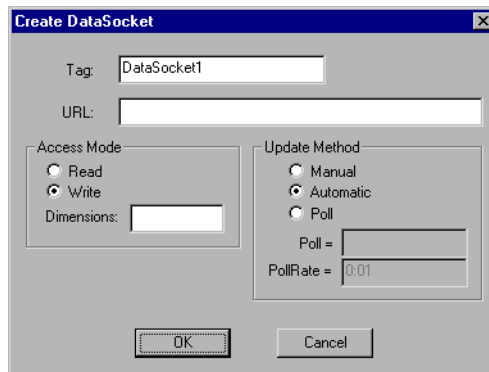

**Access Mode** specifies whether the DataSocket object is reading or writing to the DataSocket server. If the server data is in the form of an array, you must set the array dimensions in the **Dimensions** field to write to the array.

**Update Method** specifies how Lookout updates information being published by the DataSocket server. If you select **Manual**, Lookout updates data when you trigger the `Update` data member. With **Automatic** updates, Lookout automatically watches for data to change and updates it when a change occurs. Selecting **Poll** lets you choose a triggered poll or set a poll rate of your own to update the data.



**Poll** is a logical expression. When this expression changes from FALSE to TRUE, Lookout polls the device. Use a simple expression like the signal from a pushbutton, or a complex algorithm.

**PollRate** is a numeric expression that determines how often to poll the device. Lookout polls the device at the specified time interval. Normally, this is a simple time constant such as 0:01 (one second). Refer to the *Numeric Data Members* section of Chapter 2, *How Lookout Works*, in the *Getting Started with Lookout* manual for information about entering time constants.



**Note** The DataSocket object does not work unless you connect it to the server. Use a Switch object connected to the Connect data member to activate the DataSocket object.

## Accessing DataSocket Arrays

Lookout does not use arrays for handling data in an HMI, but many data sources do use arrays. If you need to read from or write to a DataSocket server item that is an array, the DataSocket permits you to use multiple data members, one for each element in the array.

### Configuring the DataSocket Object to Write to an Array

If you are writing to an array item, configure the object by selecting the **Write** option in the **Access Mode** section of the **Create DataSocket** dialog box. This enables the **Dimensions** field, where you enter the dimension of the array item.

If the array item is a one dimensional array, enter the number of elements in the **Dimensions** field. If the array is multi-dimensional, use a colon (:) to denote the elements from the rows and succeeding layers. The following table shows examples of how to define various arrays.

Array Size	Entry in the Dimensions Field
1-Dimensional array with 17 elements	17
2-Dimensional array with 10 elements in 20 rows	10:20
3-Dimensional array with 12 levels of 15 elements in 32 rows	15:32:12

You do not need to define the dimensions of an array to read data from with the DataSocket object.

## Configuring DataSocket Object Data Members to Access an Array

To access an array element, add an array index element to the generic **data.num**, **data.logical**, or **data.text** data members. In this way you can access any or all of the elements in the array you are trying to access.

Add the index numbers in object connections or in Lookout yellow expression fields either as a panel display expression or in variables.

You can also create alias data members with index elements.

As when configuring the DataSocket object to write to an array, use numbers and the colon (:) to serve as the index for the data you are reading from or writing to the array. The syntax for data members is *DataSocketName*.data:*N*:*N*.num where *DataSocketName* is the object name and *N* represents index numbers, as shown in the following table.

Indexed Data Member	Array element
<code>DataSocketName.data:3.num</code>	accesses element 3 in a one-dimensional array of numeric data.
<code>DataSocketName.data:3.logical</code>	accesses element 3 in a one-dimensional array of logical data
<code>DataSocketName.data:10:5.txt</code>	accesses element 10 in row 5 of a two-dimensional array of text data
<code>DataSocketName.data:4:6:10.num</code>	accesses element 4 in row 6 of level 10 of a three-dimensional array of numeric data.

## DataSocket Data Members

**Table 2-10.** DataSocket Data Members

<b>Data Member</b>	<b>Type</b>	<b>Read</b>	<b>Write</b>	<b>Description</b>
AccessMode	text	yes	no	Reports whether your DataSocket object is updating manually, automatically, or by polling, and whether it is set to read or write.
CommFail	logical	yes	no	Object-generated signal that is on if, for whatever reason, Lookout cannot communicate with the device.
Connect	logical	no	yes	When TRUE, connects the DataSocket object to the selected server. When FALSE, disconnects the DataSocket object from the server.
data.logical	logical	yes	yes	Use this data member if the DataSocket server item you are connecting to is a logical value.
data.num	numeric	yes	yes	Use this data member if the DataSocket server item you are connecting to is a numeric value.
data.txt	text	yes	yes	Use this data member if the DataSocket server item you are connecting to is a text (string) value.
DataType	text	yes	no	Returns the data type for the DataSocket server item you are connected to. This information includes the dimensions of an array, which you may find helpful in setting up your data members to access array data.
LastError	numeric	yes	no	Displays the last error code transmitted by the DataSocket server.
LastMessage	text	yes	no	Displays the last message transmitted by the DataSocket server, which may be a status message, error message, or other notification.

**Table 2-10.** DataSocket Data Members

<b>Data Member</b>	<b>Type</b>	<b>Read</b>	<b>Write</b>	<b>Description</b>
OffHook	logical	no	yes	When TRUE, this flag instructs the Scan-Data object to retain exclusive use of its assigned communication port.
Poll	logical	no	yes	When this value transitions from FALSE to TRUE, Lookout polls the device.
PollRate	numeric	no	yes	Lookout expression that determines the device polling frequency.
Status	text	yes	no	Displays whether or not your DataSocket object is connected to or disconnected from the server. This data member will also notify you if there is a connection error.
Update	logical	yes	no	Object-generated signal that pulses low each time it polls the device.
UR	text	yes	no	Displays the DSTP URL you are using to connect to the DataSocket server.

## DataSocket Status Messages

DataSocket errors are reported in the **LastError** data member, with explanatory strings reported in the **LastMessage** data member.

# DataTable

DataTables are used in the following applications:

- Multiplexing various data sources into a single display template.
- Importing or exporting large quantities of data to other applications using DDE. (Unlike the DdeTable, the DataTable provides bidirectional DDE communications. Refer to the [DdeTable](#) section for more information about using the Dde Table.)
- Networking multiple Lookout nodes Refer to Chapter 4, *Networking*, in the *Lookout Developer's Manual* for more information about using networking with Lookout.

A DataTable contains a matrix of rows and columns, much like a spreadsheet. Each column is represented by a letter (A – IV). Each row is represented by a number (1 – 1,000). Letter-number combinations represent intersections of rows and columns. Such intersections are called cells. Any given cell contains a value. A cell value can be numeric, logical, or textual.



**Note** DataTables are advanced tools that require a mastery of Lookout object databases. Make sure you understand editing, connecting to, and using object databases and aliases before creating a DataTable object. Refer to Chapter 4, *Using Lookout*, and Chapter 5, *Developer Tour*, in the *Getting Started with Lookout* manual for more information about object databases.

The following dialog box appears when you create a DataTable.

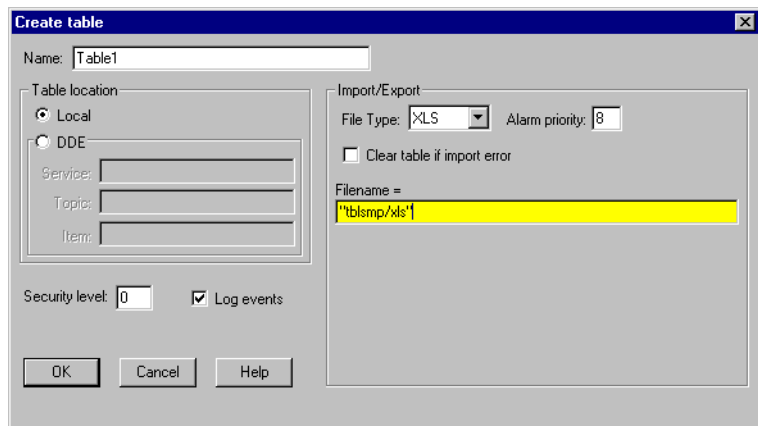

**Figure 2-10.** DataTable Definition Parameters Dialog Box

Specify **DDE** parameters if you want to use the DataTable to exchange large quantities of data from an external source (such as Excel) continuously, with both Lookout and the other program running. Refer to Chapter 5, *Dynamic Data Exchange*, in the *Lookout Developer's Manual* for more information about DDE connections to other programs.

Specify **Local** if you are using the DataTable to import or export data from Lookout into or out of a static file. Also specify **Local** if you are using the DataTable to multiplex various signals into a single display or graphic template.

To exchange data with another DataTable running in another Lookout process, you can use ordinary Lookout connections.

The export and import data members control the transfer of data between Lookout and a Microsoft Excel spreadsheet. The spreadsheet filename must be entered in the **Import/Export** section of the **Create table** dialog box.



**Note** The data table import and export data members only work with Microsoft Excel Version 4 at this time. This feature does not work with Excel Version 5 or greater.

Instead of entering a file name in the **Import/Export** dialog box, you can enter a Lookout expression in the **Filename** field. You can then import and export different files using a switch setting, a text entry box, or some other expression input. If something goes wrong with the transfer of data, including data corruption, Lookout reports an alarm.

Click on the **Clear table if import error** checkbox to clear the DataTable before importing either from a spreadsheet or an ODBC database. This only affects what happens if there is an error during the import. If there are no errors during the import, the imported data always replaces the old data in the table. However, if the checkbox is selected, the DataTable is always cleared before starting an import, so that, if an error occurs, the DataTable is left empty. If the checkbox is not checked and an error occurs, the old data is left in the table.

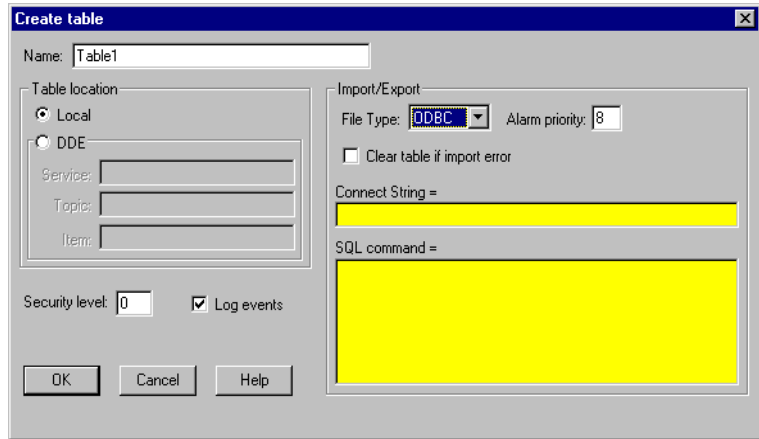

**Figure 2-11.** DataTable Definition Parameters Dialog Box; Import from ODBC Database

The **Connect String=** field specifies the DataSource Name (DSN) as well as any other parameters needed by the ODBC driver to make the connection to your chosen data source.

The **SQL command=** field is where you enter the SQL string you want to pass to the ODBC driver. Refer to the [SqlExec](#) section for more information about using SQL queries in Lookout.

## Multiplexing Displays and Graphics

You can use DataTables to multiplex signals into a single control panel, used as a template. For instance, assume you have nine identical pump stations. At each site you have a single PLC monitoring the pressure, flow rate, and status of two pumps. You are also controlling an analog output with an operator setpoint from Lookout. Instead of developing nine identical control panels in Lookout, you can build just one panel and multiplex the signals from the nine sites into a single set of graphics.

The following figure is a graphical representation of the connections for a possible DataTable.

	A	B	C	D	E	F
1	Site1	PLC1.press	PLC1.flow		PLC1.pmp1	PLC1.pmp2
2	Site2	PLC2.press	PLC2.flow		PLC2.pmp1	PLC2.pmp2
3	Site3	PLC3.press	PLC3.flow		PLC3.pmp1	PLC3.pmp2
4	Site4	PLC4.press	PLC4.flow		PLC4.pmp1	PLC4.pmp2
5	Site5	PLC5.press	PLC5.flow		PLC5.pmp1	PLC5.pmp2
6	Site6	PLC6.press	PLC6.flow		PLC6.pmp1	PLC6.pmp2
7	Site7	PLC7.press	PLC7.flow		PLC7.pmp1	PLC7.pmp2
8	Site8	PLC8.press	PLC8.flow		PLC8.pmp1	PLC8.pmp2
9	Site9	PLC9.press	PLC9.flow		PLC9.pmp1	PLC9.pmp2

**Figure 2-12.** Graphical Representation of a DataTable Showing Connections



**Note** At this time there is no actual view in Lookout for you to see this table. It is a representation, not a screen capture of a Lookout dialog box or display element.

Each row of the table is connected to the site name, the data you want to keep track of from the PLC at that site, and a place for the operator setpoint data for that site.

Notice the names of the nine PLCs (PLC1, PLC2...). Each value has an alias (press, flow, pmp1, pmp2). Each cell represents a connection made from that PLC output to the that cell of the DataTable.

The open column D represents the connection of a single Pot object called Setpoint to the column—not to individual cells. This way Lookout only changes the value of a cell in column D when that particular row has been made active. You connect the individual cells in column D (D1 through D9) to the correct holding registers (outputs) on the respective PLCs. For example, Table1.D1 would be connected to the appropriate data member of PLC1 – Table1.D2 to the appropriate data member of PLC2, and so on. In other words, when you intend to multiplex signals to a panel through a data table connect inputs from a PLC or RTU to individual cells. Connect operator setpoints (outputs) to columns.



# DataTable Example

To practice using a DataTable, you can create a PLC simulator as shown in the following illustration. You can use a separate control panel for each PLC output simulator, or place all the objects you make on one panel.

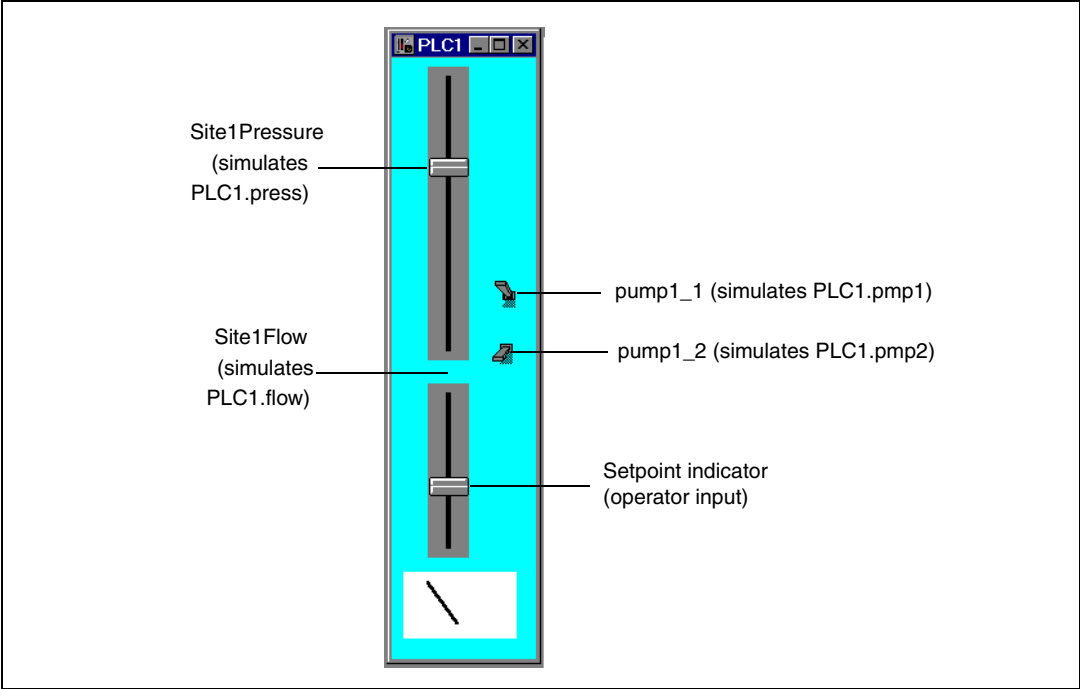

Use two slider pots as your pressure and flow outputs, and two switches as the on/off indicators for pumps one and two. You can use the dial gauge at the bottom to check the operator input, `Setpoint`. Instead of connecting the cells of your data table to PLC outputs, you connect directly to the Lookout objects, named after the outputs for clarity.

You should create at least three sets of PLC input/output simulators. The following example refers to the 9 PLCs mentioned in the [Multiplexing Displays and Graphics](#) section, but you can explore using a data table using 2 or 3 simulators.

Connect specific DataTable cells from the D column to the Setpoint indicator for each PLC simulator.

After you have built your simulators, open a new Control Panel to use as your display and create a DataTable. You will create the rest of the display in a later step.



When it first appears, the DataTable contains the number 0. This indicates the contents of cell A1. You can increase the size of the display window, but you cannot show the entire array of data in the table. You can view the contents of any cell in column A by clicking on the window when you are in run mode. Selecting the contents of that cell activates that row of the data table.

Enter text expressions into the cells of column A to act as your table index. For example, enter the string "Site 1" as the connection to your DataTable A1.txt data member. Connect the outputs of your PLC simulators to the cells in the B, C, E, and F columns shown in the following figure. You will connect an operator input to the entire column D, and then later connect individual cells in the D column to your PLC simulators.

	A	B	C	D	E	F
1	Site 1	Site1Pressure	Site1Flow		pump1_1	pump1_2
2	Site 2	Site2Pressure	Site2Flow		pump2_1	pump2_2
3	Site 3	Site3Pressure	Site3Flow		pump3_1	pump3_2
4	Site 4	Site4Pressure	Site4Flow		pump4_1	pump4_2
5	Site 5	Site5Pressure	Site5Flow		pump5_1	pump5_2
6	Site 6	Site6Pressure	Site6Flow		pump6_1	pump6_2
7	Site 7	Site7Pressure	Site7Flow		pump7_1	pump7_2
8	Site 8	Site8Pressure	Site8Flow		pump8_1	pump8_2
9	Site 9	Site9Pressure	Site9Flow		pump9_1	pump9_2

## Connecting Signals to DataTables

To connect a value to a particular cell or column within a DataTable, use the **Object»Edit Connections...** command. Select the specific data member of the DataTable to be written, and identify the data member of the source object.

### Connecting to Cells

The value from Site1Pressure is numeric. To write the value of Site1Pressure into cell B1, connect the simulated output to B1—not B1.logical or B1.txt. The **Edit connection** dialog box is shown in the following illustration.

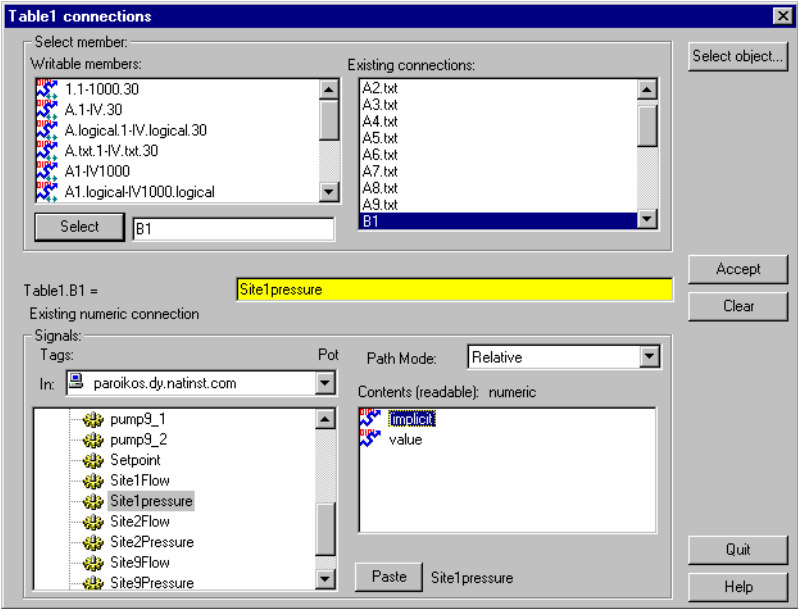
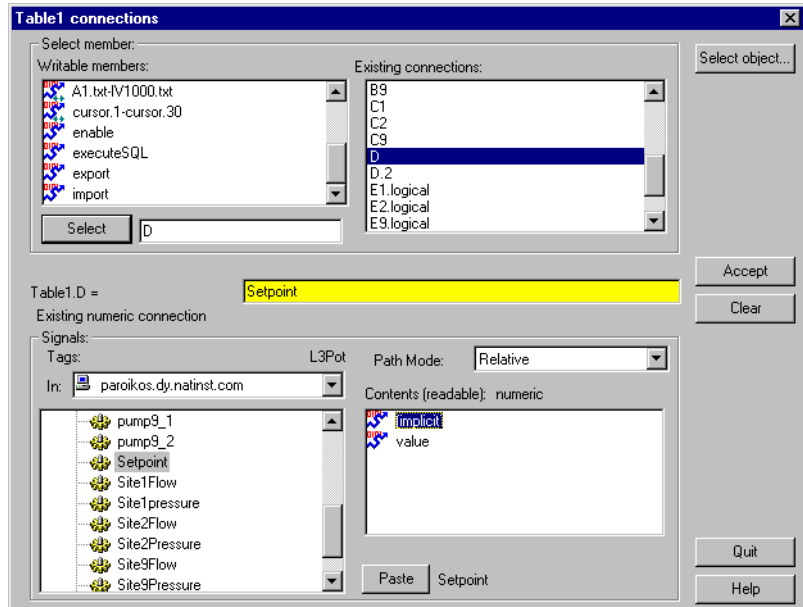

Figure 2-13. Edit Connections Dialog Box

After you establish a connection to a cell, the value within the cell changes any time the expression changes. Any time the value of Site1Pressure changes, the value within cell B1 changes.

## Connecting to Columns

To connect the value of the `Setpoint` potentiometer to column D, select `D`—not `D.logical` or `D.txt`—as shown in the following illustration. As with the previous value, you use `D` because you are using a numerical value. There is no number following the `D` because you are connecting to a column, not a cell.



**Figure 2-14.** Edit Connections Dialog Box

Once a connection to a column is established, the value within the cell *at the currently selected row* changes when the expression changes. So, if you activate row 4 and change the value of `Setpoint` changes, the value within cell `D4` changes. No other cells are affected until you move the cursor to activate another row and the operator adjusts the pot.

## Reading a Cell Value Back to a Lookout Object

When you connect the display panel potentiometer called `Setpoint` to `Table1.D`, you should configure your pot with the appropriate **Remote** parameter to ensure that it automatically adjusts to track the value in any cell (within the specified column) when the cursor moves to a new row.

**Revise potentiometer:**

Name: Pot1

Minimum: 0

Maximum: 100

Resolution: 1

Position source

Local

Remote

URL := \\parikos\tablesamp\Table1.D

DDE

Service: \_\_\_\_\_

Topic: \_\_\_\_\_

Item: \_\_\_\_\_

Control security level: 0  Log events

OK Cancel Help

## The Display Panel

Now that your DataTable (called `Table1`) is complete, you can return to your display panel (where you placed the DataTable object initially) and begin to build a single control panel that allows you to multiplex the data from your PLCs. A sample panel is shown in the following illustration.

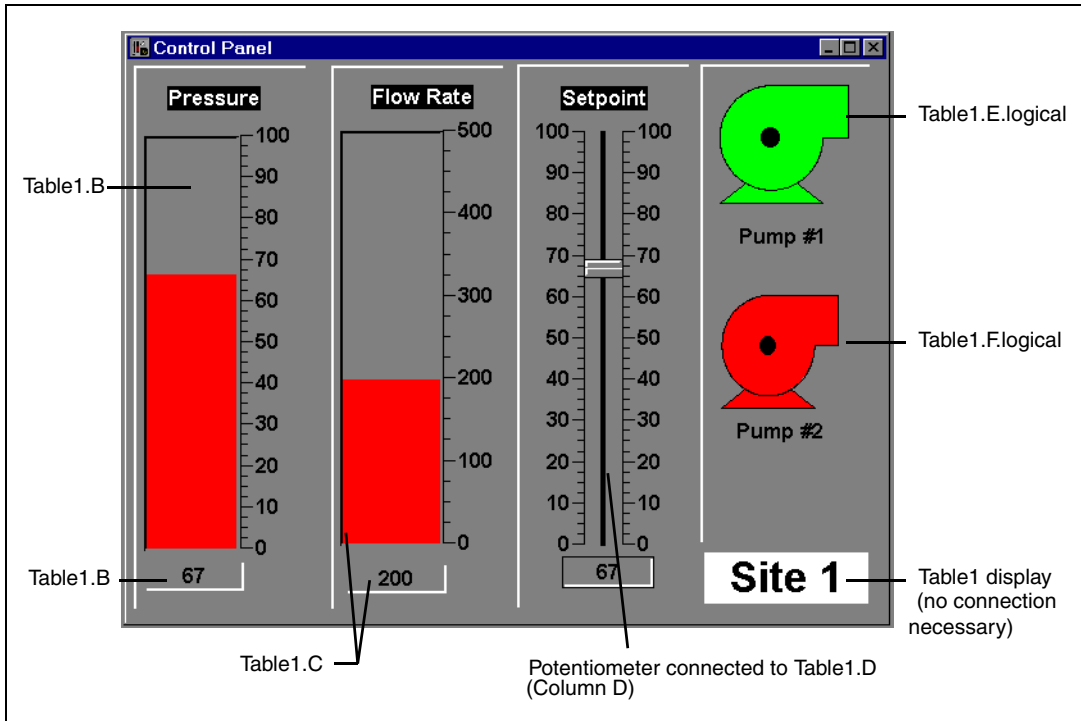

Instead of using expressions that reference the actual values from your driver objects to display values, use the column names from `Table1`. For instance, the bar graph and numeric readout for Pressure both represent the expression `Table1.B`. The actual value for `Table1.B` depends on the what row is currently active in the DataTable. In the illustration row 1 is active, so all the expressions return the value in their respective columns at row 4. The callouts in the picture indicate how the control panel was developed. All are Lookout expressions except the Pot and the DataTable, which are displayable objects.

## Operating Your Multiplexed Panel

The plate in bottom right corner of the control panel is the DataTable object (Table1). To view a different site with the control panel (that is, to activate a different row, thereby selecting a different PLC), click on Table1 and the following dialog box should appear.

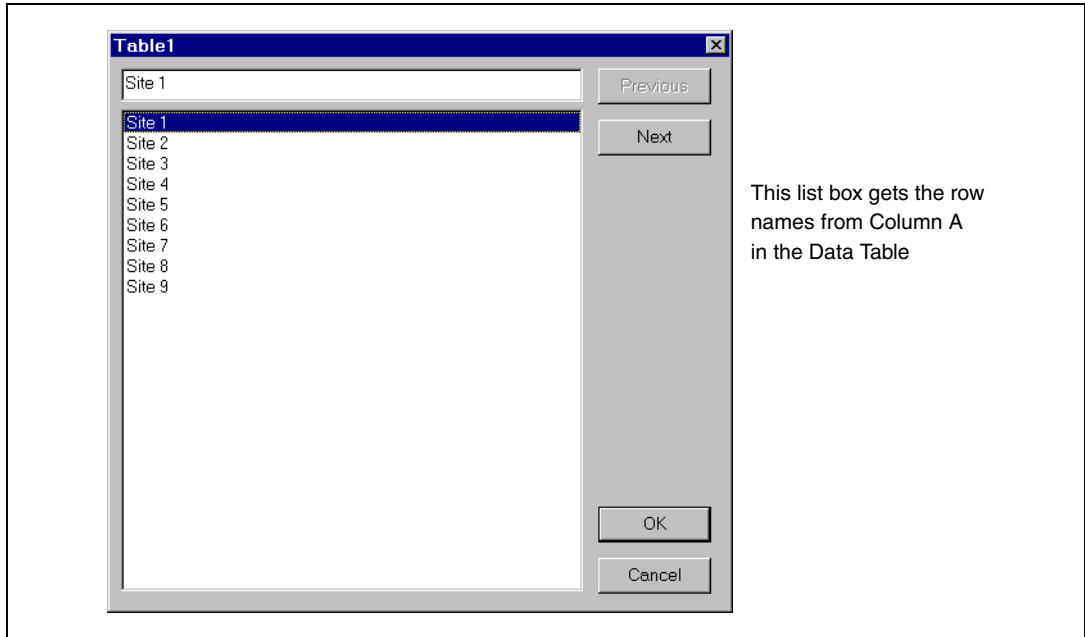

By selecting a site, you connect your control panel to the PLC at that site. This is referred to as moving the cursor to that row.

## DataTable Cursors

The cursor is a DataTable pointer that you can move from row to row to activate the values in the cells of that row. There are several methods for controlling the location of the cursor:

- Connect a numeric expression to the `cursor` data member. A typical example would be to connect a potentiometer (minimum = 1, maximum = the number of rows in table, resolution = 1) to the cursor.
- Connect logical expressions to appropriate row numbers. A typical example would be to create a pushbutton for every row and then connect them to their respective row numbers.

- Use the display (list box) built into the DataTable object. A typical example was described previously where you connected text values to cells in column A and then displayed the table as a plate.

The following example provides a graphical representation of a DataTable (called Table1) showing typical values within its many cells. You can create a multiplex effect in Lookout by referencing column names and then selecting the row with the information you want to use. If you reference column names (instead of individual cells), the DataTable outputs only the values within the currently selected row. If you reference individual cells, the DataTable outputs the current value within the cell—no matter where the cursor is.

	A	B	C	D	E	F
1	Site 1	67.8	540	56	0	1
2	Site 2	77.9	460	43	0	1
3	Site 3	57.3	480	78	0	1
4	Site 4	57.8	410	51	1	1
5	Site 5	51.8	560	92	1	0
6	Site 6	88.3	490	40	0	1
7	Site 7	79.4	530	63	1	0
8	Site 8	92.1	520	71	1	0
9	Site 9	59.9	550	62	0	1

<b>Outputs =</b>	<b>Site2</b>	<b>77.9</b>	<b>460</b>	<b>78</b>	<b>0</b>	<b>1</b>
------------------	--------------	-------------	------------	-----------	----------	----------

Figure 2-15. DataTable with Cursor at Row 2 and Corresponding Outputs



The value of cell B2 is currently 77.9. Therefore, the `Table1.B` data member is also 77.9. If you move the cursor to row 9, the value of `Table1.B` changes to 59.9, as shown.

	A	B	C	D	E	F
1	Site 1	67.8	540	56	0	1
2	Site 2	77.9	460	43	0	1
3	Site 3	57.3	480	78	0	1
4	Site 4	57.8	410	51	1	1
5	Site 5	51.8	560	92	1	0
6	Site 6	88.3	490	40	0	1
7	Site 7	79.4	530	63	1	0
8	Site 8	92.1	520	71	1	0
9	Site 9	59.9	550	62	0	1

<b>Outputs =</b>	<b>Site9</b>	<b>59.9</b>	<b>550</b>	<b>62</b>	<b>0</b>	<b>1</b>
------------------	--------------	-------------	------------	-----------	----------	----------

**Figure 2-16.** DataTable with Cursor at Row 9 and Corresponding Outputs

## Using Multiple Cursors

The previous description assumes you are using just one cursor. But a DataTable can have up to 64 cursors. Multiple cursors allow you to select multiple rows at the same time. When using multiple cursors, you also use multiple names for each column. For a given column, each name is associated with a given cursor. If you are using two cursors in the previous example (`cursor` and `cursor.2`), you can reference the column name of a given column as follows.

**Table 2-11.** Column Names

	A	B	C	D	E	F
cursor	A.txt	B	C	D	E.logical	F.logical
cursor.2	A.txt.2	B.2	C.2	D.2	E.logical.2	F.logical.2

Earlier, when you were using just one cursor, you connected the value of a potentiometer called `Setpoint` to column D. Subsequently the value of `Setpoint` was written to the cell at the row selected by the cursor. But when there are multiple cursors, you have to select which cursor you are writing to. Thus, depending on how you want your table to work, you might connect the potentiometer to both `Table1.D` and `Table1.D.2`.

## DataTable Data Members

Table 2-12. DataTable Data Members

Data Members	Type	Read	Write	Description
executeSQL	logical	no	yes	Imports data from an ODBC database into the DataTable when value goes high, using the connect string and SQL command you enter in the Create/modify DataTable dialog box.
(implicit)	DdeTable	no	no	Not displayable in Lookout, but it can be referenced by a DDE link from another application.
1.1–1000.64	logical	no	yes	Specifies row (1, 2, 3, ...1000) or specifies row.cursor (for example, 24.2 is the selector for row 24, cursor 2). Upon transition from false to true, the specified cursor moves to specified row.
A.1–IV.64	numeric	yes	yes	<p>Specifies column names (for example, A, B, C...IV) or specifies column names and associated cursor numbers (such as, A.1, B.1, A.2, B.2, and so on.)</p> <p><i>Read</i>—returns a numeric value from the cell specified by the column and currently selected row of the indicated cursor.</p> <p><i>Write</i>—writes a numeric value into the cell specified by the column and currently selected row of the indicated cursor.</p>

**Table 2-12.** DataTable Data Members (Continued)

Data Members	Type	Read	Write	Description
A.logical.1 – IV.logical.64	logical	yes	yes	<p>Specifies column names (for example, A.logical, B.logical, C.logical, ...IV.logical) or specifies column names and associated cursor numbers (such as, A.logical.1, B.logical.1, A.logical.2, B.logical.2, and so on.)</p> <p><i>Read</i>—returns a logical value from the cell specified by the column and currently selected row of the indicated cursor.</p> <p><i>Write</i>—writes a logical value into the cell specified by the column and currently selected row of the indicated cursor.</p>
A.txt.1 – IV.txt.64	text	yes	yes	<p>Specifies column names (for example, A.txt, B.txt, C.txt, ...IV.txt) or specifies column names and associated cursor numbers (such as, A.txt.1, B.txt.1, A.txt.2, B.txt.2, and so on.)</p> <p><i>Read</i>—returns a text value from the cell specified by the column and currently selected row of the indicated cursor.</p> <p><i>Write</i>—writes a text value into the cell specified by the column and currently selected row of the indicated cursor.</p>
A1 – IV10000	numeric	yes	yes	Specified cell interpreted as numeric value
A1.logical – IV10000.logical	logical	yes	yes	Specified cell interpreted as logical value
A1.txt –IV10000.txt	text	yes	yes	Specified cell interpreted as text value

**Table 2-12.** DataTable Data Members (Continued)

<b>Data Members</b>	<b>Type</b>	<b>Read</b>	<b>Write</b>	<b>Description</b>
Cursor.1 – Cursor.64	numeric	yes	yes	Specifies the currently selected row of the indicated cursor.
enable	logical	yes	yes	If TRUE (the default), enables DDE. If FALSE, disables DDE. The default value is on. The input is ignored for non-DDE TextEntry objects.
export	logical	no	yes	When this input transitions from false to true, the Lookout data table is exported to the designated spreadsheet file.
import	logical	no	yes	When this input transitions from false to true, the Lookout data table imports data from the designated spreadsheet.
mdcursor	numeric	yes	yes	Updates a cell or a row in a data table without an event from Lookout. For example, with the ordinary cursor, changing rows only updates those cells where the connected value has changed. If you use <b>mdcursor</b> , all cells update when the cursor changes.
Modified	logical	yes	no	Pulses TRUE when any cell value in the DataTable changes.
Update	logical	yes	no	Pulses each time the cursor changes rows. Often used to “call up” a control panel.

**Related Objects** [DdeTable](#), [DdeLink](#)

# DdeLink

DdeLink creates a unidirectional Dynamic Data Exchange (DDE) link to another application. The other application could be running on the same computer or on another computer over a network. DdeLink objects provide an easy way to *import* remote values into Lookout. Refer to Chapter 5, *Dynamic Data Exchange*, in the *Lookout Developer's Manual* for more information about DDE. For each DdeLink object you define, Lookout creates a separate link to the other application. If you need to import large quantities of data, you should use the DdeTable or DataTable object. Refer to the *DdeTable* section and the *DataSocket* section for more information about using these objects.

## DdeLinks on Same Computer

If you are importing values from another application running on the same computer, your DDE parameters will look similar to the ones in the following illustration.

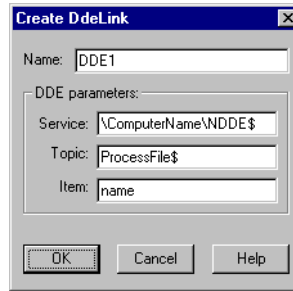

**Figure 2-17.** DdeLink Definition Parameters Dialog Box (Same Computer)

**Service** specifies the application name, **Topic** specifies the file, and **Item** points to the individual value (r1c1 refers to the cell at row1, column1. Unfortunately, Excel does not support the more convenient A1 cell references with DDE).

## DdeLinks to Remote Computer

If you are importing values from another application running on a remote computer, your DDE parameters will look similar to the ones in the following illustration.



**Figure 2-18.** DdeLink Definition Parameters Dialog Box (Remote Computer)

Notice the differences in the **Service**, **Topic**, and **Item** parameters. The backslashes (\\) and dollar signs (\$) are standard requirements for making network connections in Microsoft Windows. `ComputerName` specifies the network name of the computer you are connecting to. If you are connecting to a value in another Lookout application, `ProcessFile` is the Lookout file name running on the remote computer, and `Name` refers to the name you are linking to.

## DdeLink Data Members

**Table 2-13.** DdeLink Data Members

Data Members	Type	Read	Write	Description
(implicit)	numeric	yes	no	DDE link interpreted as numeric value.
enable	logical	yes	yes	If TRUE (the default), enables DDE. If FALSE, disables DDE. This input is ignored for non-DDE TextEntry objects.
hot	logical	yes	no	Status of DDE link.
logical	logical	yes	no	DDE link interpreted as logical value.
txt	text	yes	no	DDE link interpreted as text value.

**Related Objects** [DdeTable](#), [DataSocket](#)

# DdeTable

DdeTable creates a unidirectional Dynamic Data Exchange (DDE) link to another application. The other application could be running on the same computer or on another computer over a network. Refer to Chapter 5, *Dynamic Data Exchange*, in the *Lookout Developer's Manual* for more information about DDE. You can use DdeTable to *import* large quantities of data from other applications. The table format is much more efficient at transferring data than the Link format because a table can contain hundreds or even thousands of data points that all share a single link. On the other hand, the link format can only transfer a single value per link—and every link requires a certain amount of CPU overhead. If you are only importing a relatively small amount of data, you may find the DdeLink technique easier to implement.

## DdeTable on Same Computer

If you are importing values from another application running on the same computer, your DDE parameters will look similar to the ones in the following figure.



**Figure 2-19.** DdeTable Definition Parameters Dialog Box (Same Computer)

**Service** specifies the application name, **Topic** typically specifies the file, and **Item** specifies the particular data item name.

The following example shows an Excel spreadsheet with the highlighted range named Data.

	Data		Pressures	
	A	B	C	D
1	Pressures	Temps	Flows	Times
2	99	574.9	12	1:23:04
3	11	442	21	0:30:13
4	98.51	602.4	34	0:57:45
5				
6	Ammonia	Chlorine	Alum	Status
7	0.076	1.34	27.87	ON

You can now display any value in the range Data with this Lookout DdeTable object.

Select **Insert»Expression...** and then choose the DdeTable data member corresponding to the Excel spreadsheet cell containing the value you want to display. Make sure that the type of data member you select matches the type data in the spreadsheet cell.

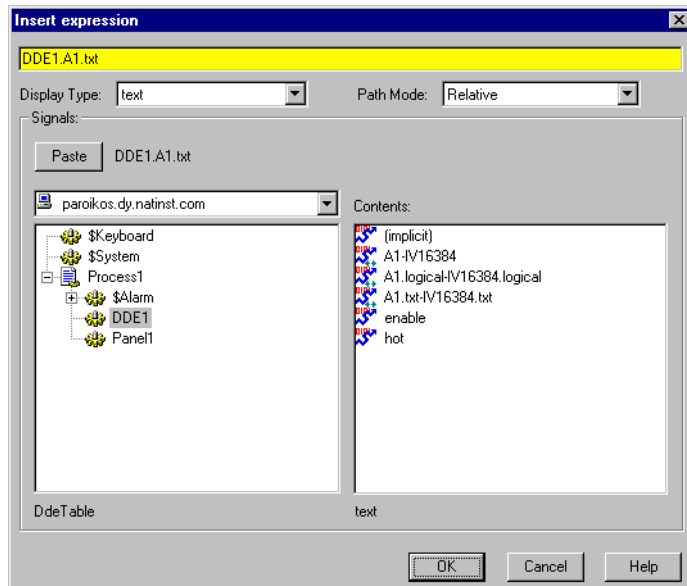
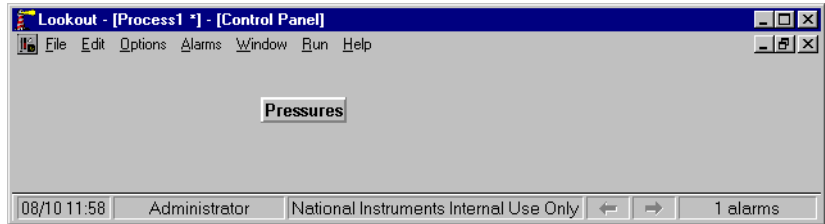

Figure 2-20. Inserting a DdeTable Expression



Notice the reference for the displayed item in the Lookout status bar.



## DdeTable to Remote Computer

Using the DdeTable object over a network is somewhat different from the previous example.

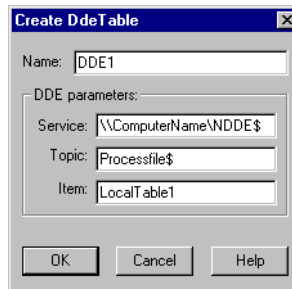

**Figure 2-21.** DdeTable Definition Parameters Dialog Box (Remote Computer)

Notice the differences in the **Service**, **Topic**, and **Item** parameters. The backslashes (\\) and dollar signs (\$) are standard requirements for making network connections in Windows. `ComputerName` specifies the network name of the computer you are connecting to. If you are connecting to a DdeTable or DataTable in another Lookout application, `ProcessFile` is the Lookout file name running on the remote computer, and `LocalTable1` refers to the DdeTable or DataTable object you are linking to.

## DDETable Data Members

**Table 2-14.** DdeTable Data Members

<b>Data Members</b>	<b>Type</b>	<b>Read</b>	<b>Write</b>	<b>Description</b>
(implicit)	numeric	yes	no	Cell A1 interpreted as a numeric value
A1 – IV16384	numeric	yes	no	Specified cell interpreted as a numeric value
A1.logical – IV16384.logical	logical	yes	no	Specified cell interpreted as a logical value
A1.txt – IV16384.txt	text	yes	no	Specified cell interpreted as a text value
enable	logical	yes	yes	If TRUE (the default), enables DDE. If FALSE, disables DDE. This input is ignored for non-DDE TextEntry objects.
hot	logical	yes	no	Status of DDE link

**Related Objects** [DataSocket](#), [DdeLink](#)

# DelayOff

DelayOff is an adjustable delay timer. When **On/off signal** transitions to off, the **Timer delay** begins to count down. At the end of the delay countdown, the output signal turns off. **On/off signal** must remain off during the time delay period for the output signal to turn off. The output immediately turns on when the **On/off signal** turns on.

**Timer delay** can range from 0.0 seconds to several years, and the effective resolution is 0.1 seconds over the entire range. The timer display digitally shows the time delay remaining, and is updated approximately once per second. If the **On/off signal** is high, the timer display shows `on`. If the **Timer delay** period has expired, the display shows `off`.

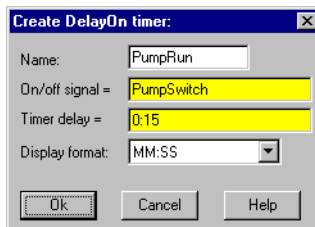

Figure 2-22. DelayOff Definition Parameters Dialog Box

The **On/off signal** is a logical expression while **Timer delay** is a numeric expression. Normally, this is a simple time constant such as 0:20—twenty seconds. Refer to the *Numeric Data Members* section of Chapter 2, *How Lookout Works*, in the *Getting Started with Lookout* manual for information about entering time constants.

## DelayOff Data Members

Table 2-15. DelayOff Data Members

Data Member	Type	Read	Write	Description
(implicit)	logical	yes	no	Logical timer value

**Comments** The DelayOff timer can prevent a pump from short-cycling.

**Related Objects** [DelayOn](#), [Interval](#), [OneShot](#), [Pot](#), [TextEntry](#)

# DelayOn

DelayOn is an adjustable delay timer. When **On/off signal** transitions to on, the **Timer delay** begins to count down. At the end of the delay countdown, the output signal turns on. **On/off signal** must remain on during the time delay period for the output signal to turn on. The output immediately turns off when the **On/off signal** turns off.

**Timer delay** can range from 0.0 seconds to several years, and the effective resolution is 0.1 seconds over the entire range. The timer display digitally shows the time delay remaining and is updated approximately once per second. The timer display shows `off` when the **On/off signal** is low. If the **Timer delay** period has expired, the display shows `on`.

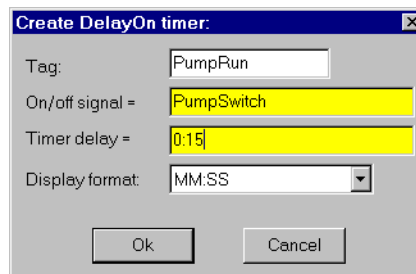

**Figure 2-23.** DelayOn Definition Parameters Dialog Box

The **On/off signal** is a logical expression while **Timer delay** is a numeric expression. Normally, this is a simple time constant such as 0:20—twenty seconds. Refer to the *Numeric Data Members* section of Chapter 2, *How Lookout Works*, in the *Getting Started with Lookout* manual for more information about entering time constants.

## DelayOn Data Members

**Table 2-16.** DelayOn Data Members

Data Member	Type	Read	Write	Description
(implicit)	logical	yes	no	Logical timer value

**Comments** The DelayOn timer can be used to prevent pumps from cycling too often, to allow one operation to complete before another begins, or to require a condition to exist for a period of time before an alarm is activated.

**Related Objects** [DelayOff](#), [Interval](#), [OneShot](#), [Pot](#), [TextEntry](#)

# Derivative

Derivative can also be called a rate of change object—it calculates the rate of change of the incoming numeric input signal. You can use this class to calculate the rate at which a tank is filling or draining, or to convert a changing totalized flow value into a flow rate. The output units are in Input Units/Time Unit.

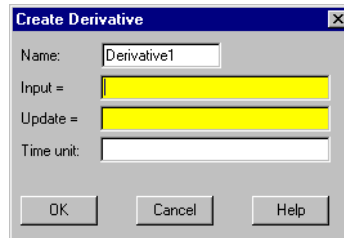

**Figure 2-24.** Derivative Definition Parameters Dialog Box

The previous example calculates the rate of change in the water level of a tank. Lookout polls the RTU connected to the tank level transmitter every 5 minutes, so this example uses the RTU update data member as the Update pulse for the Derivative object. Tanklevel is in feet and Time unit is 1 minute, so the output result is in feet per minute.

**Input** is the numeric expression you are monitoring for rate of change.

**Update** can be a logical expression or numeric constant. If you specify **Update** as a numeric constant, it creates an internal pulse timer with a pulse period of the specified time and a pulse duration of zero. Refer to the *Numeric Data Members* section of Chapter 2, *How Lookout Works*, in the *Getting Started with Lookout* manual for more information about entering time constants. If you specify **Update** as a logical variable, the variable should pulse at the frequency you want to use.

The **Update** expression triggers the calculation of a new rate-of-change based on the **Input** value at the prior **Update**, and the current **Input** value. The current **Input** value is then stored as the prior **Input** value for the next calculation. The **Update** period should be greater than the refresh rate of the incoming signal; or if the Input is generated directly by external I/O, the update data member generated by the PLC object should be used. If the **Update** period is less than the **Input** refresh rate, the rate of change calculation fluctuates erratically between zero and a high value.

**Time unit** is a numeric expression used as the basis for unit time on the Input signal. For instance, if the rate of change should be in feet per minute, the Input signal would be feet, and **Time unit** would be one minute (entered as 1:00). Typically the **Time unit** is one second (0:01), one minute (1:00), one hour (1:00:00), or one day (1:00:00:00). However, you can specify any unit, such as 5:23 (a rate of change in Input units per five minutes and 23 seconds).

## Derivative Data Members

**Table 2-17.** Derivative Data Members

Data Member	Type	Read	Write	Description
(implicit)	numeric	yes	no	Rate of change

**Comments** Derivative performs the inverse function of Integral—you can theoretically run a signal through an Integral object and then a Derivative object (or vice versa) and you would end up with the original signal. (Discretization of the time calculations by the computer may cause the final and original signals to differ somewhat).

It is important to consider the resolution of the process variable measured by the PLC when determining the Update period for this object. For instance, if a pressure transmitter connected to a PLC only has a resolution of 0.5 psi and you want to measure rates down to 1 psi/minute, the Update pulse must be greater than 30 seconds even if the PLC is polled once per second (i.e.,  $0.5 \text{ psi}/1 \text{ psi/min.} = 30 \text{ sec.}$ ). For this application, the Update pulse should probably be about two minutes.

**Related Objects** [Integral](#)

# DialGauge

The DialGauge object class displays a numeric signal as a sweeping needle on an analog gauge or dial.

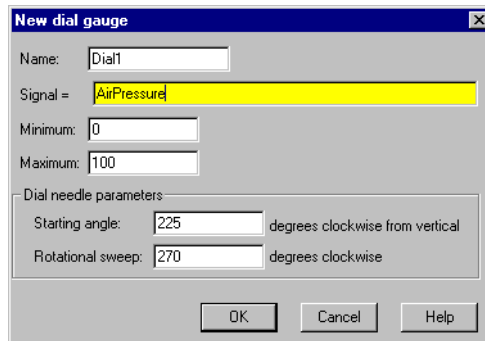

**Figure 2-25.** DialGauge Definition Parameters Dialog Box

**Signal** is a numeric expression.

**Starting angle** indicates the position of the needle when the **Signal** is at its **Minimum** value. As shown here, you specify the starting needle position by counting the degrees clockwise from vertical.

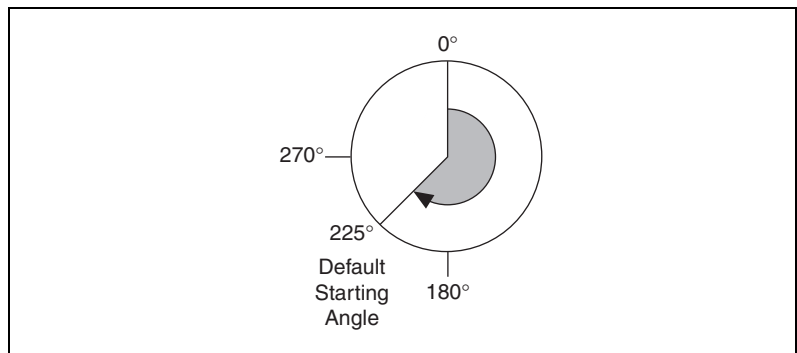

**Rotational sweep** specifies the number of degrees clockwise that the needle will rotate as the **Signal** approaches the **Maximum** value. As shown in the diagram here, you count the **Rotational sweep** in degrees clockwise from the **Starting angle**.

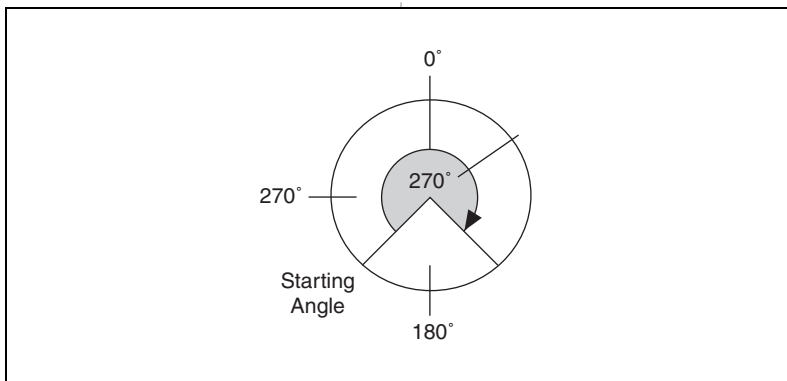

When you place a DialGauge on a panel, the Display dial gauge dialog box appears, as shown in the following figure.

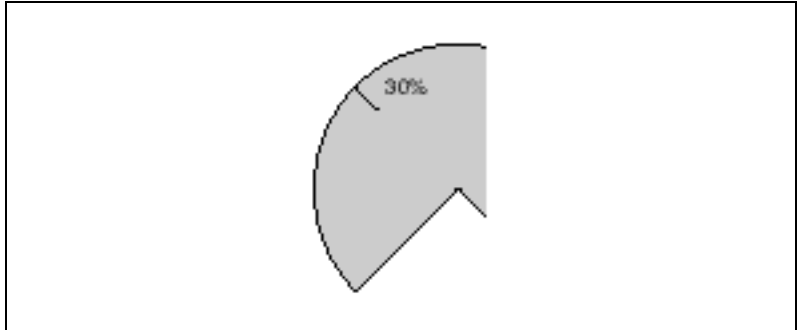

**Figure 2-26.** DialGauge Display Parameters Dialog Box

**Needle thickness** defines how wide your needle will be. Thickness can range from one pixel (hairline) to 10 pixels wide.

**Needle length** specifies the length of the needle as a percent of the radius. At 30 percent, for example, only the outer tip of the needle is visible—you cannot see the part of the needle closest to the origin. At 100 percent, the needle extends the full radius of the circle.





## DialGauge Data Members

**Table 2-18.** DialGauge Data Members

Data Members	Type	Read	Write	Description
(implicit)	numeric	yes	no	Current value of signal parameter
graphic1-graphicN	numeric	yes	no	Denotes which display of this object will appear on an HTML report. Only one display is available for the ActiveX object.

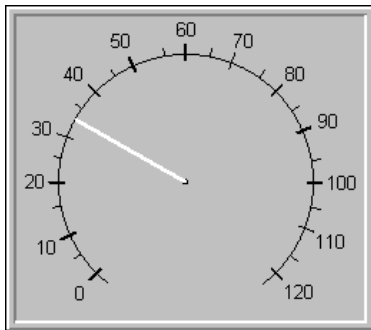

**Comments** The DialGauge object class only displays a needle. You may wish to enhance it with a corresponding scale or dial face as shown. You can create a scale or dial face by importing one from a graphics package. Refer to the *Creating Custom Graphics* section of Chapter 2, *Graphics*, in the *Lookout Developer's Manual* for more information about creating graphics in Lookout.



**Note** If you choose to import a scale or dial face from an external package, you should use a bitmap instead of a metafile. This makes the display refresh cleaner when the needle changes position.

**Related Objects** [\(expression\)](#), [Gauge](#)

# ElapsedTime

ElapsedTime is an elapsed time meter or “hour meter” that totals the amount of time the **Enable** expression is on. If **Enable** is the logical constant ON, the meter reflects the time since the process was started. If a **Reset** expression is specified, the meter resets to zero the moment **Reset** transitions from off to on. The display always shows the elapsed time, and is updated approximately once per second.

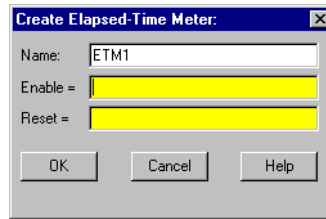

Figure 2-27. ElapsedTime Definition Parameters Dialog Box

## ElapsedTime Data Members

Table 2-19. ElapsedTime Data Members

Data Member	Type	Read	Write	Description
(implicit)	numeric	yes	no	Total elapsed time—updated once per second, while meter is running

**Comments** ElapsedTime meters are used primarily to record the amount of time that individual pieces of equipment have been running. It is also straightforward to set up an alarm that sounds when a particular device has been operating for a certain time and needs routine servicing. The plant operator could then perform the service and reset the ElapsedTime meter with a pushbutton.

ElapsedTime can also record the amount of time a particular device is operated each day and you can record the resulting time to a daily Spreadsheet which you can then use to automatically reset the meter after the data is permanently recorded.

# Event

Event is a flexible and powerful object class you can use to define event messages that are triggered based on a user-defined logical expression. Lookout logs such events to the Citadel database and you can subsequently print and archive them. Refer to Chapter 7, *Logging Data and Events*, in the *Lookout Developer's Manual* for more information about logging events.

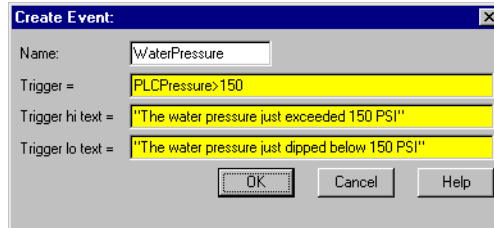

**Figure 2-28.** Typical Settings for an Event

When the result of the **Trigger** logical expression transitions from FALSE to TRUE, it logs the result of the **Trigger hi text** expression as an event in the EVENT.DAT file. When the results of the **Trigger** expression transitions from TRUE to FALSE, it logs the results of the **Trigger lo text** expression as an event.

## Event Data Members

**Table 2-20.** Event Data Members

Data Member	Type	Read	Write	Description
none	—	—	—	Event objects do not have data members

**Comments** For each event logged, Lookout records the date and time, the name of the user currently logged on, and the expression text.

Although event messages are shown for both **Trigger hi text** and **Trigger lo text**, you do not have to include text in both fields.

## (expression)

Named expressions, shown as (expression)s, are flexible, powerful real-time calculators. They create and calculate the result of spreadsheet-style formulas that include a mixture of constants and signals from other objects. There are over fifty built-in functions that you use in expressions, including logical, mathematical, statistical, text and trigonometric functions. Refer to Chapter 1, *Expressions*, in the *Lookout Developer's Manual* for more information about expressions and expression functions.

Named expressions can be short and simple, or extremely complex with several signal inputs, function calls, and multiple levels of parentheses. A single expression may incorporate text, logical, and numeric calculations. The variable type returned by the outermost function or operator in the expression determines the signal type generated by the expression.

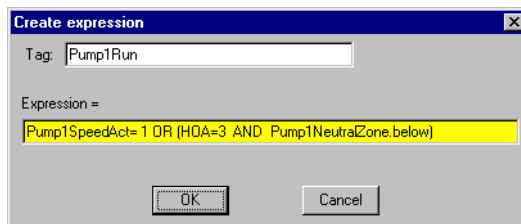

**Figure 2-29.** Create Expression Dialog Box



**Note** You typically use (expression) objects when you need to define a unique condition that is used multiple times throughout your application.

When you define an (expression) object (as opposed to inserting an intrinsic expression), you create a unique name for your expression and can therefore reference the output signal generated from the expression in other expressions or objects. Instead of defining the same expression in many places, you create it one time and use its name any time you need this expression.



**Note** The expression may not express a **condition**.

**Table 2-21.** Expression Data Members

<b>Data Member</b>	<b>Type</b>	<b>Read</b>	<b>Write</b>	<b>Description</b>
(implicit)	numeric, logical, or text	yes	no	Value of expression. The variable type returned by the outermost function or operator in the expression determines the signal type generated by the expression.

# Flipflop

Flipflop changes its logical output signal from on to off, or from off to on when the **Input** signal goes high. The output signal does not change when the signal goes low. **Input** is a logical expression.

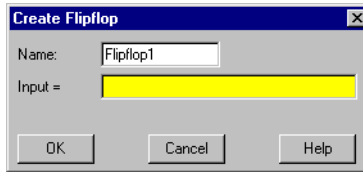

Figure 2-30. Flipflop Definition Parameters Dialog Box

## Flipflop Data Member

Table 2-22. Flipflop Data Member

Data Member	Type	Read	Write	Description
(implicit)	logical	yes	no	Current state

**Comments** Flipflop can be used to alternate the operation of two pumps, or when connected to a pushbutton, provides a pushbutton on/off control device.

**Related Objects** [LatchGate](#)

# Gauge

Gauge displays the **Signal** expression in digital or bar graph format. Gauge display parameters change depending on the values of the **Conditional expressions**. Gauge determines which colors to display based on the order and current status of your conditional expressions. For instance, if several conditional expressions are true at once, Gauge displays the color associated with the first true expression.

You can use the **Transparent** background style with numeric expressions and gauges displayed as bar graphs. This means you can have bar graphs with transparent backgrounds.

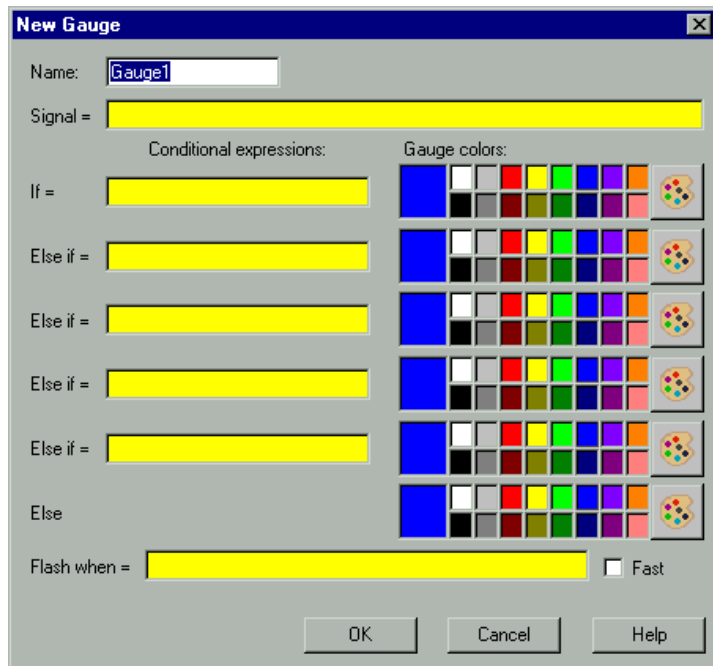

**Figure 2-31.** Gauge Definition Parameters Dialog Box



**Conditional expressions** and **Flash when** are logical expressions while **Signal** is a numeric expression. The **Fast** option instructs the Gauge to flash faster when enabled than when disabled.

## Gauge Data Members

**Table 2-23.** Gauge Data Members

<b>Data Member</b>	<b>Type</b>	<b>Read</b>	<b>Write</b>	<b>Description</b>
(implicit)	numeric	yes	no	Numeric value of Gauge
graphic1-graphicN	numeric	yes	no	Denotes which display of this object will appear on an HTML report. Only one display is available for the ActiveX object.

**Comments** You should use a Gauge object when you need a bar graph or digital display to change colors and/or flash upon certain conditions. If you do not need either of these capabilities, you should display a bar graph or digital value with the **Insert»Expression** command.

# Histogram

The Histogram object class is one of the Lookout Statistical Process Control (SPC) tools and can play an important role in a Total Quality Management (TQM) program. This object class displays the distribution and/or relative distribution of a signal value. It shows the central tendency and variability of the sampled data. It also calculates process capability ratio (PCR), PCR confidence interval, mean, variance and standard deviation.

Figure 2-32. Histogram Definition Parameters Dialog Box

**Sampled signal** identifies the value that you are statistically monitoring. Histogram reads and categorizes the **Sampled signal** any time **Sample trigger** transitions from off to on.

You can either **Categorize** all samples since **Reset** last transitioned from off to on, or you can **Categorize** a sliding window of the most recent 2 – 1000 samples.

**Bin Settings** define the **Number** of desired categories. The difference between **Minimum** and **Maximum** determines the width of each bin or category.

The settings for the following Histogram graph call for eight bins. Because the difference between **Minimum** and **Maximum** is 80 and because there are eight bins, each class interval has a range of 10 ( $80/8 \text{ bins} = 10$ ). So  $\text{bin}_1$  contains sample values ranging from zero to less than 10;  $\text{bin}_2$  contains sample values ranging from 10 to less than 20, and so on.

This object always allocates two more bins than you request. These bins are used for accumulating samples less than the **Minimum** and greater than the **Maximum**. The lower bin is always data member  $f_0$ . The upper bin is  $f_{n+1}$ , where  $n = \text{Number in Bin Settings}$ .

In the following example,  $\text{Bin}_0$  (data member  $f_0$ ) contains all sample values less than **Minimum** and  $\text{bin}_9$  contains all sample values greater than or equal to **Maximum**.

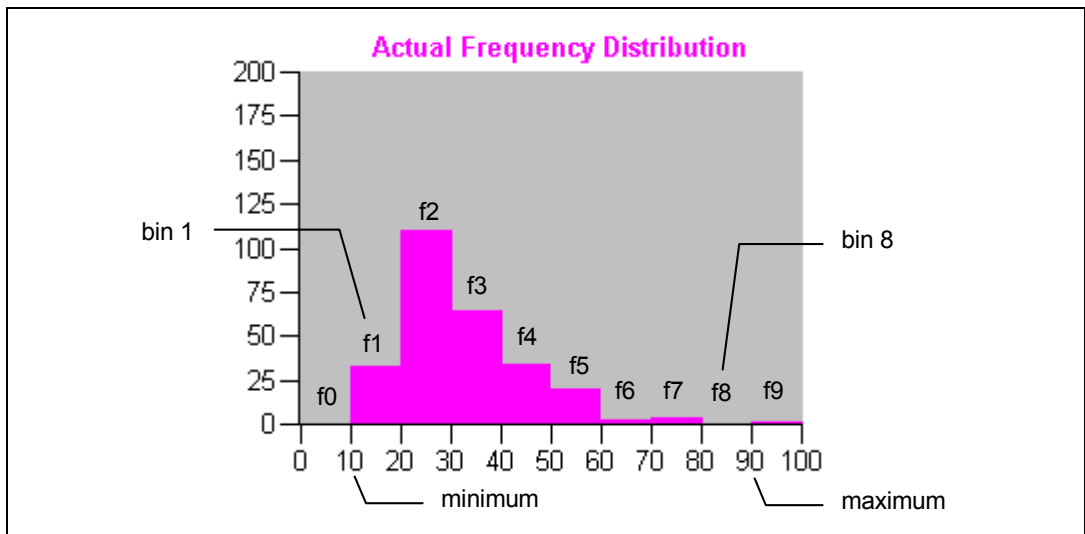

**Figure 2-33.** Graph from Inserting Ten Numeric Expression Barcharts (Data Members  $f_0$  through  $f_9$  as Shown) and Two Scales

**LSL** and **USL** identify the lower and upper specification limits. These limits generally define the range of acceptable sample values. Histogram uses **LSL** and **USL** to calculate the process capability ratios (**PCR** and **PCR<sub>k</sub>**).

The **Confidence level** expresses the degree of certainty or probability that the actual value of **PCR** (the process capability ratio) falls within the confidence interval (that is, between **PCRL** and **PCR<sub>U</sub>**). A typical value is 95 percent. The lower the confidence level, the tighter the interval.



**Note** Histogram does not have a display parameters dialog box. However, you can easily display the results of its output signals by referencing them in expressions.

## Histogram Data Members

**Table 2-24.** Histogram Data Members

Data Member	Type	Read	Write	Description
f0 – f201	numeric	yes	no	Frequency of sampled signal values falling within the identified bin
LSL	numeric	yes	no	Lower specification limit
mean	numeric	yes	no	Average of sampled values, where $\bar{x} = \frac{\sum_{i=1}^n x_i}{n}$
PCR	numeric	yes	no	Process capability ratio measuring the uniformity or variability of the sampled signal using upper and lower specification limits. This ratio measures <i>potential</i> capability. If standard deviation = 0, PCR = 0. Otherwise $PCR = \frac{USL - LSL}{6\sigma}$
PCRk	numeric	yes	no	One-sided process capability ratio for an off-center process. This ratio takes process centering into account, measuring <i>actual</i> capability. $PCR_k = \min\left(\frac{\bar{x} - LSL}{3\sigma}, \frac{USL - \bar{x}}{3\sigma}\right)$
PCRL	numeric	yes	no	Lower limit of the confidence interval
PCRU	numeric	yes	no	Upper limit of the confidence interval
rf0 – rf201	numeric	yes	no	Relative frequency (percent) of sampled signal values falling within the identified bin

**Table 2-24.** Histogram Data Members (Continued)

<b>Data Member</b>	<b>Type</b>	<b>Read</b>	<b>Write</b>	<b>Description</b>
samples	numeric	yes	no	Number of sampled signal values
sdev	numeric	yes	no	Sample standard deviation, where $\sigma = \sqrt{\frac{\sum_{i=1}^n (x_i - \bar{x})^2}{n-1}}$
USL	numeric	yes	no	Upper specification limit
variance	numeric	yes	no	Sample variance, where $\sigma^2 = \frac{\sum_{i=1}^n (x_i - \bar{x})^2}{n-1}$

**Comments** The confidence interval is the range of values determined by the limits PCRL and PCRU.

**Related Objects** [Average](#), [Maximum](#), [Minimum](#), [Sample](#), [XBarR](#)

**Related Functions** Avg, Max, Min, Stdev, Stdevp, Sum, Var, Varp  
Refer to Chapter 1, *Expressions*, of the *Lookout Developer's Manual* for more information about these functions.

# HyperTrend

---

A HyperTrend object displays a trend graph on a control panel. It plots any number of logical and numeric trend lines.

HyperTrends provide instant access to both real-time and historical data in a single graph. For each plot line, they combine both real-time and historical data into a seamless, contiguous trace of data. Refer to the *Citadel Historical Database* section of Chapter 7, *Logging Data and Events*, in the *Lookout Developer's Manual* for more information about transmitting data.

In earlier versions of Lookout, creating a trend line in a HyperTrend object automatically logged the requested data to the database.

In Lookout 4 and later, you must select the Log to historical database option in the Edit Database dialog box for any data you want to display in a HyperTrend object before you can display the data. This is because logging must be configured in a Lookout Server process, while trending is typically done in a separate Lookout client process.

You can log information by connecting to a symbolic link, but only if the data source the symbolic link represents has had the Log to historical database option selected.

You can pan and zoom both the X axis and the Y axis in the HyperTrend plot, enabling dynamic adjustment of the vertical and horizontal resolutions of each plot line on the graph. Using this feature, you can, for example, zoom into a particular area of focus on the trend.

The graph scrolls from right to left, plotting current, real-time signals at the right end of the graph.

The icon in the upper left of the display accesses a menu you can use to change the group of traces being plotted, activate the cursor, and start or stop scrolling. The arrow-shaped buttons make it easy for you to scroll the trend graph forward and back in time. It provides instant access to data that has scrolled off the left end of the graph (that is, historical data stored in the Citadel database).

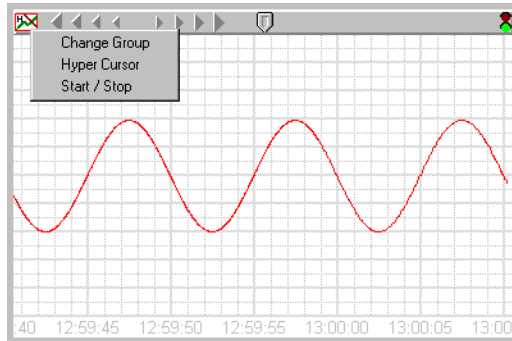

The button bar includes scroll arrows, a cursor button, date, time, and a stop and go light. Use the scroll arrows to move back and forth through time—the bigger the arrow button you select, the further the trend jumps in time. The scroll arrows also function much like a horizontal slider. Click on them and slide the mouse left and right while holding down the mouse button. The further you slide the cursor from dead center, the faster the trend scrolls in that direction.

Use the date and time indicators to choose a specific month, day, year, hour, minute, or second. If you click on the lower part of the hour, for example, it jumps back in time by one hour.

If you click on the upper part of the hour, it jumps ahead by one hour.



It works the same way for month, day, year, minute and second.

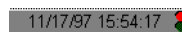

The stop & go light on the button bar is either red or green. If the light is green, it indicates the far right edge of the trend window displays the current time.

When you scroll back in time or if you click on the light when it is green, it changes to red, indicating that the trend is temporarily frozen in time. The date and time appears in the button bar indicating the exact time at the far right edge of the trend window. As you scroll back and forth through time, the data and time changes accordingly.

If you click on the light when it is red, the trend jumps back to current time and starts scrolling while plotting real-time values.



**Note** The Citadel database continues to log data no matter what state the HyperTrend is in. You do not lose any data when it is in "historical" mode (that is, when the HyperTrend is not scrolling in real-time).

When you click on the cursor button, a vertical cursor bar appears in the center of the graph along with an associated cursor dialog box. The dialog box indicates the value of each trend line at the current location of the cursor. As you drag the cursor bar left and right on the trend graph, the values in the pop-up change to reflect the new cursor location.

You can select how the trend line values are shown by choosing a format through the cursor control menu.

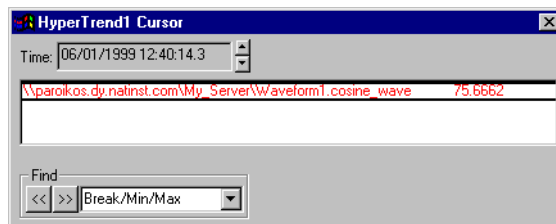

**Figure 2-34.** HyperTrend Cursor Dialog Box

**Time** indicates the current location of the cursor bar. The increment and decrement buttons beside the field move the cursor left and right in the trend graph. Choose the size of the incremental move by clicking on the desired portion of the date/time. The hour portion is selected in the previous example, so each time you click on the increment or decrement button, the cursor bar jumps ahead or back by an hour. It works the same way for any portion of the date and time.

Use the **Find** combo box to search for a break in the trend line, a signal peak or valley, or a specific value. For example, you can find the last instance in which a process control limit value was exceeded. To find the last time a trend line crossed a specific value, choose the desired trend line by clicking on it in the list box, select **Value** in the **Find** combo box, enter the desired value, and click on the scroll back button.



To create a hypertrend object, choose **Object»Create** or right-click on a process in the object explorer and select **New Object**. Select **HyperTrend**. The following dialog box appears.

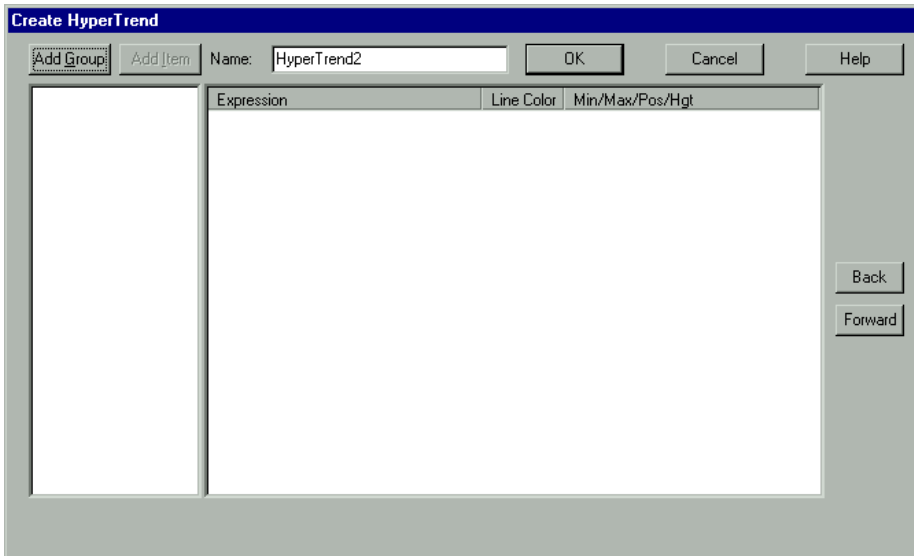

First you must create a group of trends. Double-click on the **AddGroup** button. The following dialog box appears.

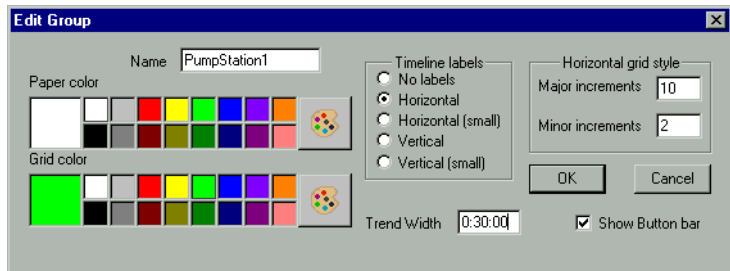

Configuring the group sets the appearance of the HyperTrend object when it displays traces from that group. You can set different paper and grid colors for different groups to help operators distinguish between them.

Give your group a name that clearly identifies it. Be sure to set the **Trend Width** for the period of time you want under observation for that group. Graphs may have a default width, or time span, of anywhere from two seconds to four years. The default **Trend Width** in the example dialog box indicates a time span of 1:00:00 or one hour. Refer the *Numeric Data*

*Members* section of Chapter 2, *How Lookout Works*, of the *Getting Started with Lookout* manual for more information about entering time constants. After creating the HyperTrend object, you can make the trend width adjustable by connecting a numeric signal to the TrendWidth data member.

**Major increments** specifies the number of heavy horizontal grid lines on a trend graph. This value is independent of the range of any trend expressions.

**Minor increments** specifies the number of light horizontal grid lines between the major increment grid lines on a trend graph. This value is independent of the range of any trend expressions.

After you create a group, you must add individual items. Right-click on the group you want to add a trace to. Select **Add Item** (or click on the **Add Item** button). The following dialog box appears.

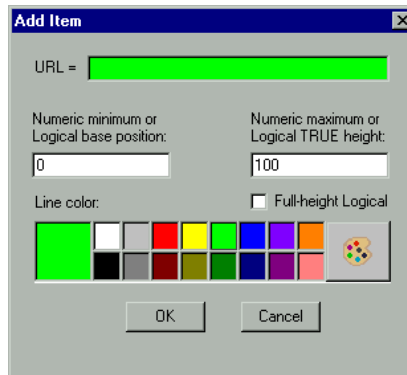

Right-clicking in the URL field displays the object selection dialog box covering all the registered computers running Lookout on your network. Select the computer and process generating the value you want to display on your HyperTrend chart. Refer to the URLs section for more information on this type of Lookout connection.

**Minimum** and **Maximum** set the scale for the trace on your display. If you are charting a logical data member, position and height set the base display line and the height of the trace from that point when your signal goes TRUE. **Minimum** is the bottom of the graph while **Maximum** is the top of the graph, regardless of the range of the expression. These settings create an imaginary vertical scale and affect each expression independently.

For example, take two numeric expressions, both of which range from 0 to 50. Set the **Minimum** and **Maximum** to 0 and 100 on the first expression,

and  $-50$  and  $50$  on the second. The first expression plots in the bottom half of the chart while the second expression plots in the top half of the chart, even though they both fluctuate between  $0$  and  $50$ .

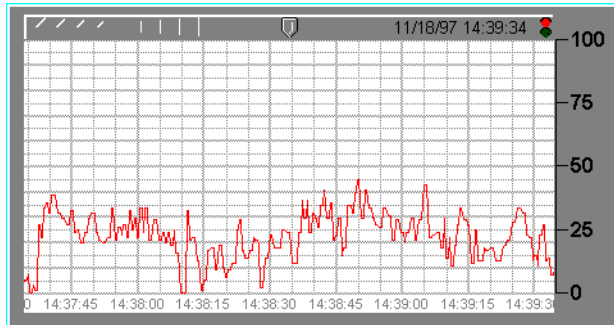

This figure shows the imaginary scale of the first expression (where min. =  $0$  and max. =  $100$ ). Because the expression ranges from  $0$  to  $50$ , it is plotted in the bottom half of the graph.

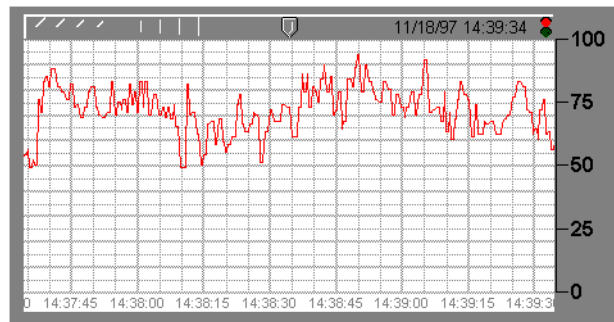

This figure shows the imaginary scale of the second expression (where min. =  $-50$  and max. =  $50$ ). Because the expression ranges from  $0$  to  $50$ , it is plotted in the top half of the graph.

When both expressions are entered on a single trend graph, you get the following effect. Notice the custom scales at either end of the graph.

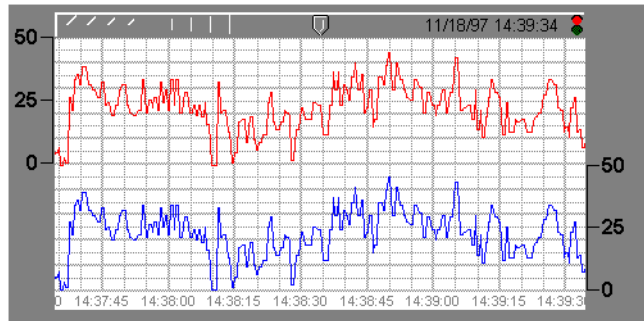

If you select Logical for the expression type, the minimum and maximum settings changes to **Position** and **Height**. These two values now represent a number between 0% and 100%, and determine the baseline location of the trend line and its unit height when the expression goes TRUE. Check the **Full-height Logical** option to plot logical data as a full-height bar on a chart.

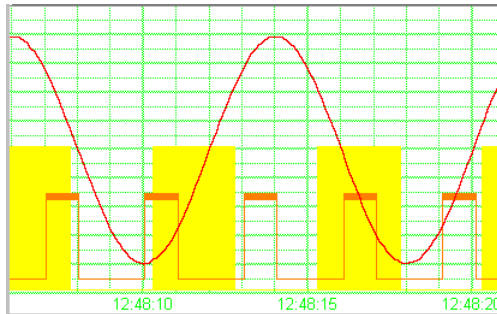

The front-to-back order that trend one is displayed can be important, as shown in the previous figure where the full-height logical trace is behind the sine wave and the single line logical trace. The item listed at the top of the Hypertrend property box is always furthest back in the display. Move items behind or in front on the display by selecting the item and clicking the **Back** or **Forward** button. Use **Insert>Scale** to label the values being charted according to your minimum and maximum settings.



**Tip** Hypertrend objects access data from the Citadel database. Think of them as windows into your historical database. Refer to Chapter 5, *Developer Tour* in the *Getting Started with Lookout* manual, and Chapter 7, *Logging Data and Events*, in the *Lookout*

*Developer's Manual*, for more information about specifying a point to be logged to the Citadel database. Use the Trend object to display data you do not want to log to the disk.

HyperTrends are updated as quickly as once per second, depending on screen resolution, the size of the graph, and the trend width setting. Computers with slow display adapters may slow down considerably when you display a large trend graph. On slower computers with slow display cards (no graphics coprocessor), consider limiting the size of your HyperTrends to less than one fourth the screen size.

If you make a HyperTrend object too small, you may crowd the cursor marker (shown in the following illustration) out of the HyperTrend control bar. If your HyperTrend is not wide enough to display the HyperCursor marker, the HyperCursor will not function. To fix this problem, resize your HyperTrend object.

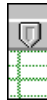

## HyperTrend Data Members

**Table 2-25.** HyperTrend Data Members

Data Members	Type	Read	Write	Description
ActiveGroup	numeric	yes	yes	Sets which of the HyperTrend trace groups is active.
Enable1– Enable 999	logical	yes	yes	When TRUE, the identified trend line is visible. When FALSE, the trend line hidden. The default value is TRUE. Trend lines are identified by the group number followed by the item number, so Enable1.2 would refer to item 2 in group 1.
graphic1-graphicN	numeric	yes	no	Denotes which display of this object will appear on an HTML report. Only one display is available for the ActiveX object.

**Table 2-25.** HyperTrend Data Members (Continued)

<b>Data Members</b>	<b>Type</b>	<b>Read</b>	<b>Write</b>	<b>Description</b>
Height1 – Height999	numeric	yes	yes	Specifies the amplitude or height of the identified trend line (distance from baseline) when the logical expression goes TRUE. Height should be between 2 and (100 minus position). Trend lines are identified by the group number followed by the item number, so Height1.2 would refer to item 2 in group 1.
HidelfOff1.1- HidelfOff999.999	logical	yes	yes	Affects only logical signals being charted on the HyperTrend. When TRUE, the logical signal does not show up on the trace when OFF. This results in logical items being charted only when TRUE, or ON.
Max1 – Max999	numeric	yes	yes	Specifies the top of the graph for the identified numeric trend line (the value of the trended line when it is at 100 percent of the Y axis). Trend lines are identified by the group number followed by the item number, so Max1.2 would refer to item 2 in group 1.
Min1 – Min999	numeric	yes	yes	Specifies the bottom of the graph for the identified numeric trend line (the value of the trended line when it is at zero percent of the Y axis). Trend lines are identified by the group number followed by the item number, so Min1.2 would refer to item 2 in group 1.

**Table 2-25.** HyperTrend Data Members (Continued)

<b>Data Members</b>	<b>Type</b>	<b>Read</b>	<b>Write</b>	<b>Description</b>
Pos1 – Pos999	numeric	yes	yes	Specifies the baseline location of the identified logical trend line. Baseline position should range should be 1–98. (pos1 is associated with trend line 1) Trend lines are identified by the group number followed by the item number, so Pos1.2 would refer to item 2 in group 1.
TrendWidth	numeric	yes	yes	Specifies the span of time that the X axis covers.
UseButtonBar	logical	yes	yes	When TRUE, the HyperTrend button bar becomes visible on the control panel. When FALSE, it is invisible. The default value is TRUE.
Visible	logical	yes	yes	When TRUE, the HyperTrend becomes visible on the control panel. When FALSE, it is invisible. The default value is TRUE.

## Converting Lookout 3.xx HyperTrends to Lookout 4 and Greater

If you convert a process created in a version of Lookout earlier than 4.0 which contains a HyperTrend object that is displaying a complex expression, Lookout automatically creates a named (expression) for the converted HyperTrend to chart. To maintain your legacy HyperTrend objects you must use or replace these (expression) objects.

# Integral

Integral is a totalizer—it totals the numeric **Input** signal. This class is typically used to total a measured flow rate.

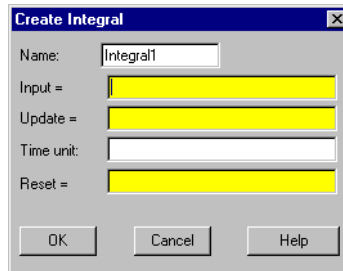

**Figure 2-35.** Integral Definition Parameters Dialog Box

**Input** is the numeric expression that you want to totalize or integrate.

**Update** can be a logical expression or numeric constant. If you specify **Update** as a numeric constant, it creates an internal Pulse timer with a pulse period of the specified time and a pulse duration of zero. Refer to the *Numeric Data Members* section of Chapter 2, *How Lookout Works*, of the *Getting Started with Lookout* manual for information about entering time constants. If you specify **Update** as a logical variable, the variable should pulse at the desired frequency.

The **Update** expression extrapolates an interim total based on the current total and the most recent Input value. The interim total is then sent out as the output. The total is calculated using the trapezoidal numeric integration technique, and the total is corrected any time the incoming signal is refreshed.

**Time unit** is a numeric expression used as the basis for unit time on the Input signal. For instance, if the Input rate is in units of gallons per minute, the Time unit should be entered as one minute (1:00) so the totalized flow is in gallons. Typically the Time unit is one second (0:01), one minute (1:00), one hour (1:00:00), or one day (1:00:00:00). However, you can specify any unit, such as 5:23 (a rate of change in Input units per five minutes and 23 seconds).

**Reset** is a logical expression that resets the totalizer value to zero upon transition from OFF to ON.





**Note** Integral does not have a display parameters dialog box. You can easily display the result of the Integral output signal by referencing its data member in an expression.

## Integral Data Members

**Table 2-26.** Integral Data Members

Data Member	Type	Read	Write	Description
(implicit)	numeric	yes	no	Totalized value

**Comments** The **Update** pulse forces the calculated total to continue changing between Input signal updates. For example, if a remote RTU that is monitoring a flow rate is polled every ten minutes, the **Update** pulse could be set at five seconds so the operator can watch the totalized flow continue to change on the screen as an extrapolated value. The corrected totalized value is calculated any time the **Input** signal refreshes—in this case, every ten minutes.

If totalized values are logged to a spreadsheet on a daily basis, for example, and the total should be reset at the end of every day, use the update pulse generated by the Spreadsheet object to reset the total—this guarantees that the total is recorded before the totalizer is reset. The example on the previous page totalizes the hourly flow for permanent data logging by a spreadsheet object named HourlySheet. Notice that the spreadsheet update pulse `HourlySheet.logged` is used to reset the totalizer.

**Related Objects** [Accumulator](#), [Counter](#), [Derivative](#)

# Interpolate

The Interpolate object class performs a linear interpolation between a set of X,Y coordinate pairs to determine a corresponding output for any given input. A single Interpolate object can have up to 1,000 coordinate pairs. Although this object class can be used for any calculation requiring linear interpolation, it is especially useful for tank strapping applications.

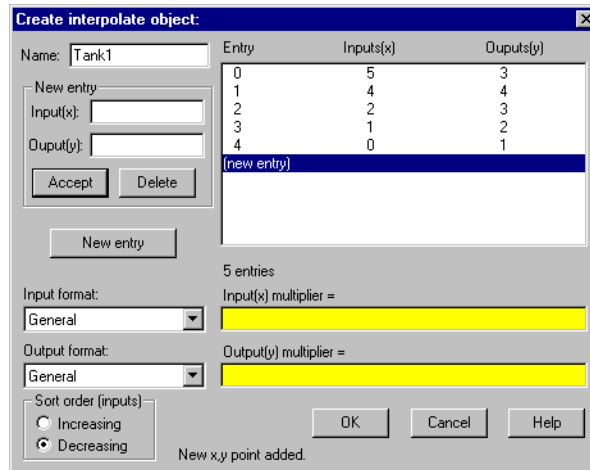

**Figure 2-36.** Interpolate Definition Parameters Dialog Box

The following diagram visually depicts the basic functionality of the Interpolate object, and the set of coordinate pairs as entered.

Based on this graphical representation of the object, you can readily see how different X inputs give corresponding Y outputs. Also notice that an X input of 5.5 yields a Y output of 2.5—even though the last coordinate pair was (5,3). Lookout uses straight line extrapolation at both end points with a slope determined by the last two coordinate pairs.

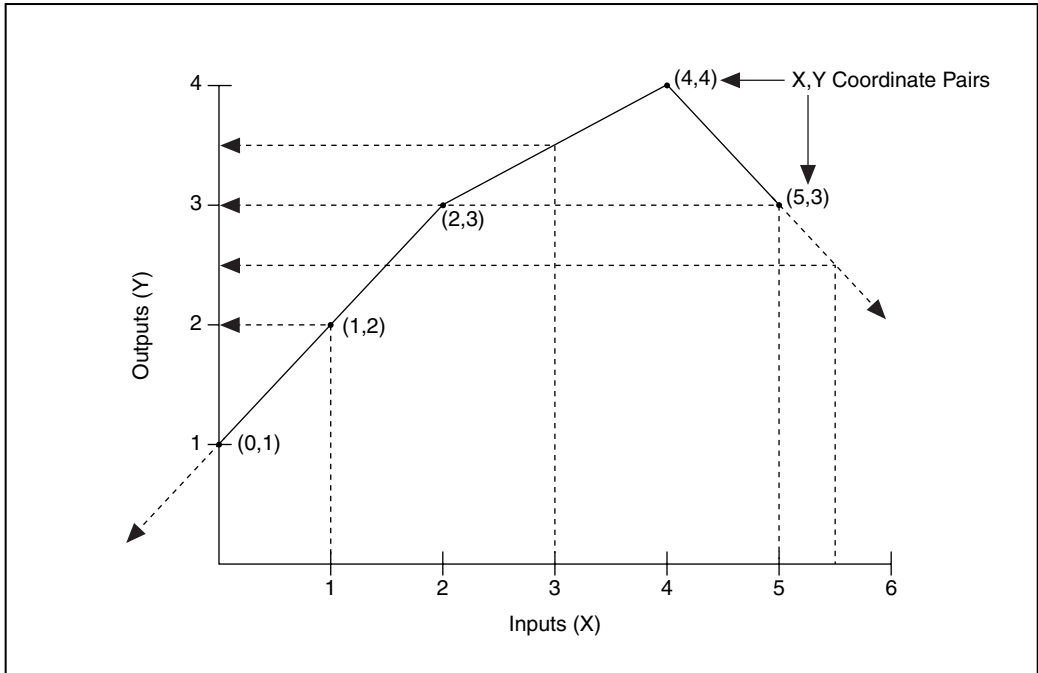

The **New entry** parameter fields enable adding, modifying and deleting **Input(x)** and **Output(y)** coordinate pairs. **Input(x)** and **Output(y)** are numeric parameters.

**Input format** and **Output format** define the of the **Input(x)** and **Output(y)** coordinate pairs displayed in the definition dialog box.

**Sort order (inputs)** specifies whether the dialog box lists X,Y coordinate pairs in **Increasing** or **Decreasing** order. The sort order has no bearing on output calculations or the values of the readable data members.

The **Input(x) multiplier** and the **Output(y) multiplier** are numeric expressions. These two parameters are useful for the more advanced calculations often found in tank strapping applications. They can be used for such things as temperature, pressure, density, and product correction factors. As their names imply, Lookout multiplies the corresponding Input/Output by the respective multiplier. If you specify an **Input(x) multiplier**, the object multiplies the input by the appropriate multiplier *before* calculating an interpolated output. If you specify an **Output(y) multiplier**, the object multiplies an interim output by the appropriate multiplier *before* calculating the final output value.

Step through a simple example using the preceding diagram to clarify this concept. Use an **Input(x) multiplier** of 1.5, and a **Output(y) multiplier** of 2. Assume the variable input is currently 2. The object first multiplies 2 by 1.5 to produce 3. It then uses the coordinate pairs to find the appropriate output value for an input of 3. As you can see, the interim output would be 3.5. Because you specified an output multiplier, it must first multiply 3.5 by 2 to give a final output of 7.

Situations may arise where you want multiple inputs going through a single Interpolate object, giving multiple respective outputs. Instead of creating an Interpolate object for each input, Lookout can connect multiple inputs to a single object and read their corresponding outputs. The inputs are writable data members (X0 – X999). For each input, there is a corresponding readable output (Y0 – Y999 respectively). The following diagram shows a numeric signal called TankLevel connected to an input, X0.

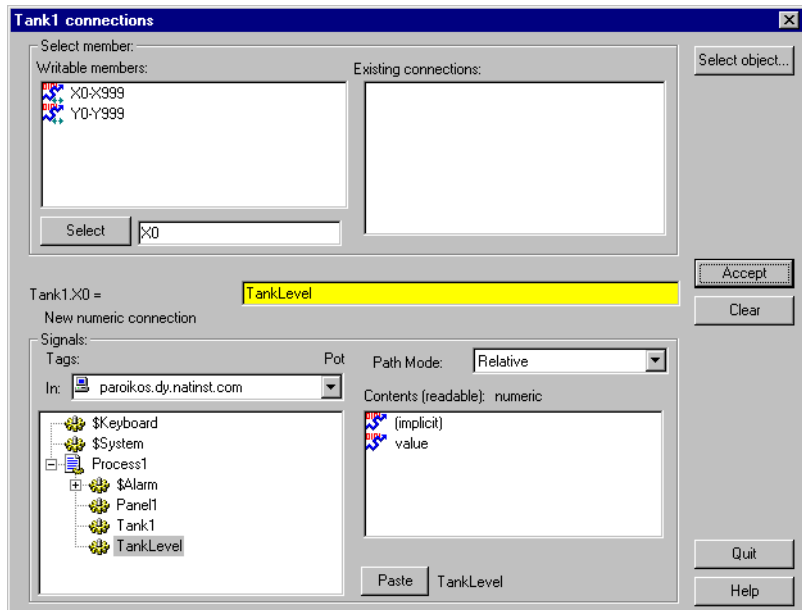

The Interpolate object now multiplies the X0 input by the **Input(x) multiplier**, find the two coordinate pair parameters that X0 falls between, interpolate, and multiply the interim output by the **Output(y) multiplier**, then send the resulting value to the Y0 readable data member.



**Note** The Interpolate object class does not have a display parameters dialog box. However, you can easily display the result of its output signals by referencing its data members in expressions.

## Interpolate Data Members

**Table 2-27.** Interpolate Data Members

Data Members	Type	Read	Write	Description
X0 – X999	numeric	yes	yes	Input value
Y0 – Y999	numeric	yes	yes	Output value. For a given input, $X_n$ , the object outputs the result of the interpolation as a corresponding $Y_n$ value.

**Comments** If you want to interpolate another input using the same coordinate pair parameters and multipliers (that is, the same Interpolate object), connect to another input like X23, and read its corresponding output, Y23.

Because  $X_n$  and  $Y_n$  data members are both readable and writable, the object can also act as a bi-directional interpolator. For example, you can connect a numeric signal to a  $Y_n$  data member, and read the corresponding interpolated  $X_n$  data member. A real-world example of this could be a typical tank strapping problem. Normally, you would use a tank level as an input to X0, and read the interpolated output Y0 as the corresponding tank volume. Hence you begin with a level and end up with a volume. However, you might also be monitoring the volume and would like to use that value to calculate a corresponding level. In that case, you might want the Interpolate object to be bi-directional, which it is. If Y0 ever changes, the object *divides* Y0 by the **Output(y) multiplier**, interpolate between the two closest **Output(y)** parameters, calculate a corresponding input value based on the two closest **Input(x)** parameters, divide it by the **Input(x) multiplier**, and send the resulting value to the X0 data member.

# Interval

Interval is an adjustable delay timer. When **On/off signal** transitions to on, its output turns on and the **Timer delay** begins to count down. At the end of the delay countdown, the output signal turns OFF. If **On/off signal** is dropped at any time, the output signal turns OFF, and the timer is reset.

**Timer delay** can range from 0.0 seconds to several years, and the effective resolution is 0.1 seconds over the entire range. The timer display digitally shows the time delay remaining. It is updated approximately once per second. If the **On/off signal** is low, or the time delay period has expired, the timer display shows OFF.

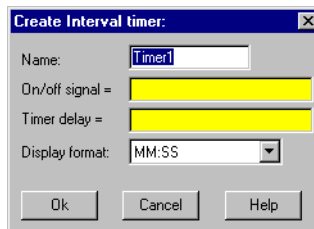

**Figure 2-37.** Interval Definition Parameters Dialog Box

The **On/off signal** is a logical expression while **Timer delay** is a numeric expression. Normally, this is a simple time constant such as 0:20 (twenty seconds). Refer to the *Numeric Data Members* section of Chapter 2, *How Lookout Works*, of the *Getting Started with Lookout* manual for more information about entering time constant.

## Interval Data Members

**Table 2-28.** Interval Data Members

Data Member	Type	Read	Write	Description
(implicit)	logical	yes	no	Logical timer value

**Comments** The Interval timer can be used to enforce a maximum run time for a pump.

**Related Objects** [DelayOff](#), [DelayOn](#), [OneShot](#), [Pot](#), [TextEntry](#)

# Joystick

Use the Joystick object to enable a joystick connected to your computer to control your Lookout processes. Create a joystick object using the following dialog box.

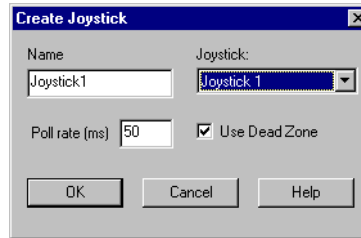

Select from up to 16 different joysticks connected to your computer. Set the **Poll rate** to determine how rapidly your joystick values are updated. Select **Use Dead Zone** to expands the range for the neutral position of the joystick. This range is called the dead zone. The joystick driver returns a constant value for all positions in the dead zone.

The joystick X and Y axis positions are reported as 32,500 when the joystick is in the neutral position. When the joystick is at the extreme left or extreme upper position, the axis position are reported as 65,000. When the joystick is in the extreme right or lower positions, the axis reports as 0.

For the Z axis and the fourth, fifth, and sixth axis, the numeric value ranges are the same as for the X and Y axis, but the control orientation -- left rudder, for instance, depends on the input device. Calibrate your joystick input carefully before using this object.

## Joystick Data Members

**Table 2-29.** Joystick Data Members

Data Member	Type	Read	Write	Description
Btn1 - Btn32	logical	yes	no	Returns status of the selected joystick button.
Connected	logical	yes	no	TRUE when joystick is connected to computer and active; FALSE if joystick cannot be detected.

**Table 2-29.** Joystick Data Members (Continued)

<b>Data Member</b>	<b>Type</b>	<b>Read</b>	<b>Write</b>	<b>Description</b>
ID	numeric	yes	no	Reports joystick number that you set in the create object dialog box.
NumButtons	numeric	yes	no	Set this to reflect the number of buttons the joystick has.
PollRate	numeric	yes	yes	Lookout expression that determines the device polling frequency.
POVPos	numeric	yes	no	Point Of View position that returns number which you can convert into a point-of-view angle.
RPos	numeric	yes	no	Current position of the rudder or fourth joystick axis.
UPos	numeric	yes	no	Current fifth axis position.
VPos	numeric	yes	no	Current sixth axis position.
XPos	numeric	yes	no	Current X-coordinate.
YPos	numeric	yes	no	Current Y-coordinate.
ZPos	numeric	yes	no	Current Z-coordinate.



# Junction

Junction receives up to nine numeric values, each of which could be the result of a complex numeric expression. It outputs the value of the last **Additional input** that changed (event driven). Notice, however, that it will not output a value until the **Initializing input** has changed. After that, any change in any input is immediately output.

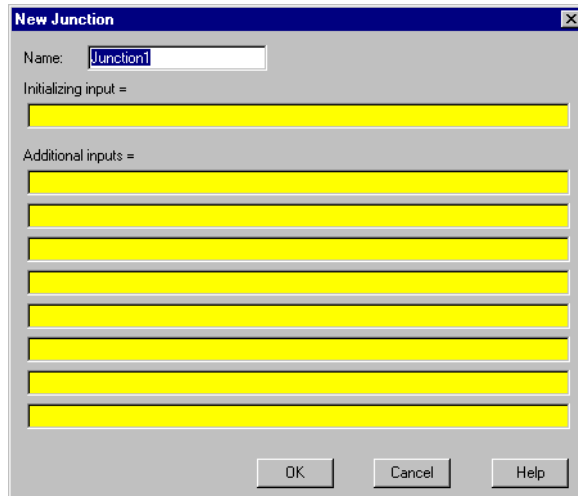

Figure 2-38. Junction Definition Parameters Dialog Box

## Junction Data Members

Table 2-30. Junction Data Members

Data Member	Type	Read	Write	Description
(implicit)	numeric	yes	no	The value of the input that most recently changed

**Comments** Junction is a unique class that should be used only in rare circumstances.

# \$Keyboard

\$Keyboard is a global object. Its data members represent the keyboard function keys. Unlike other object classes in which you can create several objects of the same class, you cannot create or delete \$Keyboard objects, but you can use the one supplied.

You can use the \$Keyboard global object to perform such functions as calling a particular control panel, activating a batch sequence, or acknowledging alarms by pressing a key.

Think of \$Keyboard data members (which represent function keys on the keyboard) as Lookout pushbuttons. Just as you can connect a pushbutton to the activate data member of a panel, you can also connect a \$Keyboard data member to the activate data member of a panel. Such a connection is shown in the following illustration.

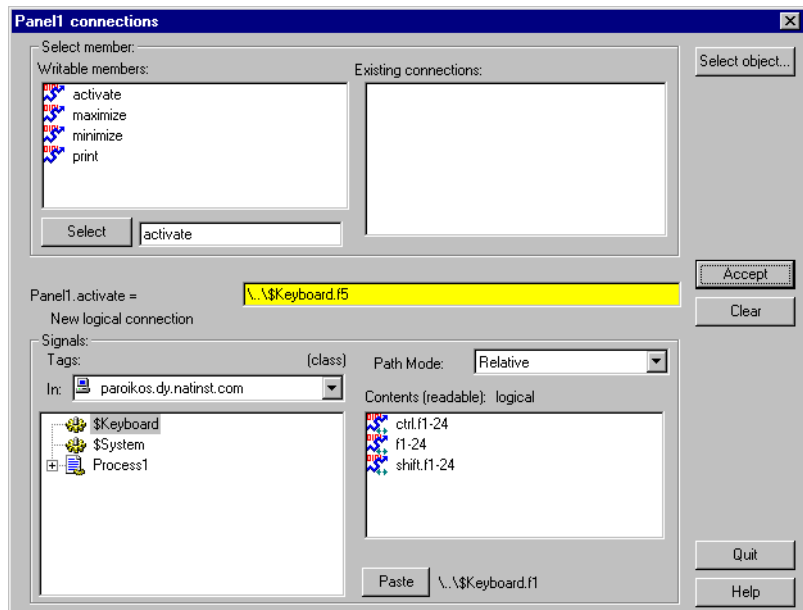

**Figure 2-39.** Edit Connections Dialog Box

The logical expression, `$Keyboard.F1` calls up Panel1 any time a user presses the F1 key on the keyboard. Similar connections could be made to other panels. You can easily connect a different panel to each function key.

Just as easily, you can connect a function key to a batch process trigger. When the key is pressed, (that is, when the `$Keyboard` data member goes TRUE) the batch is activated—reading batch ingredients from a recipe object, opening and closing valves, starting mixers, bottling finished material, and so on.

You might also connect a function key to `$Alarm.ack`. This would enable users to acknowledge alarms through a single keystroke.

## \$Keyboard Data Members

`$Keyboard` has 72 readable data members. Each data member represents a unique key sequence, described in the following table.

**Table 2-31.** \$Keyboard Data Members

Data Member	Type	Read	Write	Description
Ctrl-F1 - Ctrl-F24	logical	yes	no	Each of these 24 data members represent a function key, F1 – F24—when pressed in conjunction with the Ctrl key. A given data member returns logical TRUE when the Ctrl key and function key are pressed together and FALSE when the keys are released.
F1 - F24	logical	yes	no	Each of these 24 data members represent a function key, F1 – F24. A given data member returns a logical TRUE when its associated function key is pressed and FALSE when the key is released.
Shift-F1 - Shift-F24	logical	yes	no	Each of these 24 data members represent a function key, F1 – F24—when pressed in conjunction with the Shift key. A given data member returns logical TRUE when the Shift key and function key are pressed together and FALSE when the keys are released.

**Comments** \$Keyboard function keys are global in nature. Any time F1 is pressed, the `$keyboard.F1` signal goes TRUE—regardless of what panel the user is looking at. If you want a function key to be unique from one control panel to the next, use the Panel object class function key data member. Refer to the [Panel](#) object class definition for more information.

**Related Objects** [L3Pushbutton](#), [Pushbutton](#)

# L3Pot



**Note** L3 objects are for backward compatibility when using Lookout versions previous to Lookout 4.0.

L3Pot is a potentiometer that you use to change numeric setpoint values. You can display pots on a control panel as a knob, vertical slider, horizontal slider, increment/decrement pushbuttons, or digital entry. You can also use pots as multiple-position switches.

If you change the background color of a panel and add a Pot object displayed as a slider, its color is always gray. To change the background color of a Pot to match your panel, select the Pot object, then pick **Change»Background Color** from the menu.

**Figure 2-40.** L3Pot Definitions Parameters Dialog Box

**Minimum** is the lowest value signal the Pot will generate.

**Maximum** is the highest value signal the Pot will generate.

**Resolution** is the smallest increment of change, or detent spacing the Pot supports.

**Position source** determines where the value of the Pot resides. **Local** indicates the value of the Pot lies within the object itself—on the control panel.

**Remote** pots get their values from a remote source, often the register on a controller they are connected to. Adjusting the Pot changes the value in the register, and changing the value in the register adjusts the Pot. In effect, the Pot is tracking a remote value. This is especially useful when you want to prevent Lookout from changing the value of setpoints or registers upon initial startup, or reconnection of lost communication. When you use this style Pot you are creating a kind of looped signal. Half the loop is formed when you connect the controller register to the Pot with the **Position** expression, while the second half is formed when you connect the Pot output signal to the controller register. **Position** is a numeric expression. Do not forget to complete the second half of the loop with the **Object>Edit Connections...** command.

Much like Remote Pots, **DDE** (Dynamic Data Exchange) Pots get their values from a remote source. This could be a cell in a spreadsheet, another DDE aware application, or a second copy of Lookout running on the network. The last DDE parameters used on any object automatically become the default values for any new DDE object. Refer to Chapter 5, *Dynamic Data Exchange*, of the *Lookout Developer's Manual* for more information about Service, Topic, and Item parameters.

**Control security level** specifies the minimum security level operators must have to gain access to this individual object, and thus control it.

The **Log events** option creates a permanent audit trail for the object—who did what and when. All adjustments of the Pot are logged to disk, including the time of the adjustment, the operator account name, and what adjustment was made. Refer to Chapter 7, *Logging Data and Events*, in the *Lookout Developer's Manual* for more information about event logging.

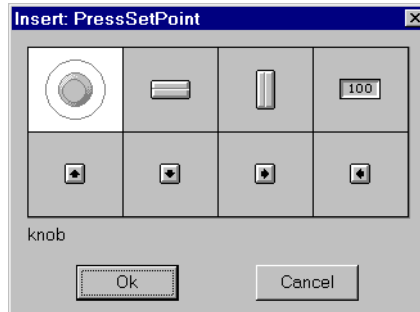

**Figure 2-41.** L3Pot Display Parameters Dialog Box



**Note** You can modify the background color on vertical and horizontal sliders with the **Change»Background color** menu command, or by right-clicking the object. You can modify the font and font color of digital pots the same way.

## L3Pot Data Members

**Table 2-32.** L3Pot Data Members

Data Member	Type	Read	Write	Description
(implicit)	numeric	yes	no	Current value
decrement	logical	no	yes	When this data member value transitions from FALSE to TRUE, the implicit value of the Pot object decreases by the Pot <b>Resolution</b> amount.
enable	logical	no	yes	If TRUE (the default), enables DDE. If FALSE, disables DDE. The default value is on. This input is ignored for non-DDE TextEntry objects.

**Table 2-32.** L3Pot Data Members (Continued)

<b>Data Member</b>	<b>Type</b>	<b>Read</b>	<b>Write</b>	<b>Description</b>
enterValue	logical	no	yes	<p>Under specific circumstances, when this value transitions from FALSE to TRUE, pops up a <b>Enter new value</b> dialog box for an operator to use in entering a value for the pot. Refer to the note following the table for more detailed information.</p> <p>The enterValue data member is designed for use under unusual circumstances, in particular when pointing devices are not available on a computer running Lookout. Because of its unusual operation, this data member should not be used unless it is necessary for hardware reasons.</p>
increment	logical	no	yes	When this data member value transitions from FALSE to TRUE, the implicit value of the Pot object increases by the <b>Resolution</b> amount.
visible	logical	no	yes	When FALSE, the Pot object cannot be seen on the display panel. When TRUE, the Pot can be seen and controlled.



**Note** When the **enterValue** input transitions from **FALSE** to **TRUE**, and  
 if the Pot is visible,  
 if Lookout is not in edit mode, and  
 if the Pot has at least one digital display,

The **Enter new value** dialog box pops up so an operator can input a value, just as if he had clicked on the digital display.

The numeric format and position used for the dialog box are based on the digital display for a pot.

Even if the panel containing the Pot digital display is inactive, the **Enter new value** dialog box will pop up. You can prevent this by predicating the **enterValue** input on the panel's **active** data member.



**Comments** Potentiometers are one of the most common control objects used in process controls. Using Pots, a plant operator can make setpoint changes with the mouse. L3Pots also work well as HOA switches. To create an HOA switch with a Pot, specify the minimum as 1, the maximum as 3, and the resolution as 1.

The increment and decrement data members enable quick connection of pot objects to \$Keyboard and Panel function keys, and screen Pushbuttons. These are often used to control Pot objects when Lookout is running on an industrial PC platform that has restricted or no mouse functionality.

# L3Pushbutton



**Note** L3 objects are for backward compatibility when using Lookout versions previous to Lookout 4.0.

L3Pushbutton generates a logical signal for receipt by other objects. A pushbutton changes state when you position the cursor over it and press the mouse button, trackball, touchscreen, or space bar. The pushbutton remains depressed and the output signal remains high until you release the button. If a **Verify on** message is defined, the operator must first acknowledge the message, then the output signal goes high, *but only momentarily*.

**Figure 2-42.** L3Pushbutton Definitions Parameters Dialog Box

**Button text** displays the specified text on the pushbutton.

Use **Verify on** to create a dynamic text expression to be displayed in a message dialog box. Refer to Chapter 6, *Security*, in the *Lookout Developer's Manual* for more information about security.

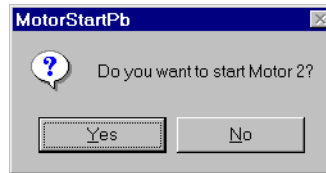

**Figure 2-43.** Verification Message Dialog Box

**Position source** determines where the value of the pushbutton resides. **Local** indicates the value of the pushbutton lies within the pushbutton itself—on the control panel. If the pushbutton is not depressed its signal is OFF, if depressed its signal is ON.

**Remote** pushbuttons get their values from a remote source, often the register in a controller they are connected to. Depressing the pushbutton changes the status of the register, and changing the status of the register depresses the pushbutton.

The **Remote** option is especially useful when you want to prevent Lookout from changing the value of setpoints or registers upon initial startup, or reconnection of lost communication. When you use this style of pushbutton you are creating a sort of looped signal. Half the loop is formed when you connect the controller register to the pushbutton with the **Position** expression, while the second half is formed when you connect the pushbutton output signal to the controller register. Position is a logical expression. Do not forget to complete the second half of the loop with the **Object»Edit Connections...** command.

When you select the **Remote** option, you can choose whether or not the pushbutton latches its output. The **Latch output** check box configures Lookout for controlling a latching-relay.

When a user clicks on a pushbutton that has latching selected, the pushbutton remains depressed, sending an ON signal (TRUE or high) until the Remote Position signal turns ON. Assume for example that an operator clicks on `MotorStartPb`, configured previously. The pushbutton remains pushed in, sending a TRUE signal, until `PLC.C101` goes TRUE. As soon as `PLC.C101` goes TRUE, the pushbutton releases.

Much like Remote pushbuttons, **DDE** (Dynamic Data Exchange) pushbuttons get their values from a remote source. This could be a cell in a spreadsheet, another DDE aware application, or a second copy of Lookout running on the network. Refer to Chapter 5, *Dynamic Data Exchange*, in the *Lookout Developer's Manual* for more information about the **Service**, **Topic**, and **Item** parameters.

**Control security level** specifies the minimum security level operators must have to gain access to this individual object, and thus control it. Refer to Chapter 6, *Security*, in the *Lookout Developer's Manual* for more information about security.

The **Log events** option creates a permanent audit trail for the object—who did what and when. Any depression of the pushbutton is recorded to disk, including the time the button was depressed, and the operator's account name. Refer to Chapter 7, *Logging Data and Events*, in the *Lookout Developer's Manual* for more information about logging events.

## L3Pushbutton Data Members

**Table 2-33.** L3Pushbutton Data Members

Data Members	Type	Read	Write	Description
(implicit)	logical	yes	no	Value of object (TRUE when button is depressed)
enable	logical	no	yes	If TRUE (the default), enables DDE. If FALSE, disables DDE. The default value is on. This input is ignored for non-DDE TextEntry objects.
visible	logical	no	yes	When FALSE, the pushbutton cannot be seen on the display panel. When TRUE, the button can be seen and controlled.

# L3Switch



**Note** L3 objects are for backward compatibility when using Lookout versions previous to Lookout 4.0.

L3Switch generates a logical signal for receipt by other objects. Switches change state when you click on them with a mouse button, trackball, touchscreen, or space bar on your keyboard.

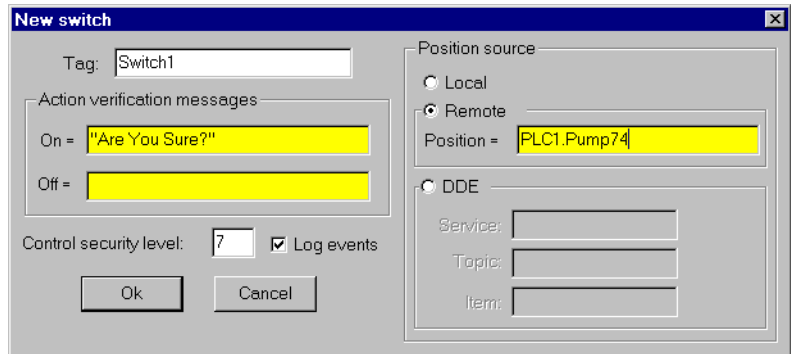

**Figure 2-44.** L3Switch Definition Parameters Dialog Box

Use **Action verification messages** to create dynamic text expressions to be displayed in message dialog boxes. Refer to Chapter 6, *Security*, in the *Lookout Developer's Manual* for more information about security.

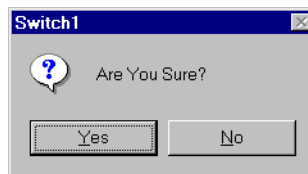

**Figure 2-45.** Verification Message Dialog Box

**Position source** determines where the value of the switch resides. **Local** indicates the value of the switch lies within the object itself—on the control panel. If the switch is up the signal is ON, if down the signal is OFF.

**Remote** switches get their values from a remote source, often the register on a controller they are connected to. Flipping the switch changes the status of the register, and changing the status of the register flips the switch.

The **Remote** option is especially useful when you want to prevent Lookout from changing the value of setpoints or registers upon initial startup, or reconnection of lost communication. When you use this style switch, you are creating a sort of looped signal. Half the loop is formed when you connect the controller register to the switch with the **Position** expression, while the second half is formed when you connect the switch output signal to the controller register. Notice **Position** is a logical expression. Do not forget to complete the second half of the loop with the **Object»Edit Connections...** command.

Much like Remote switches, **DDE** (Dynamic Data Exchange) switches get their values from a remote source. This could be a cell in a spreadsheet, another DDE aware application, or a second copy of Lookout running on the network. Refer to Chapter 5, *Dynamic Data Exchange*, in the *Lookout Developer's Manual* for more information about the **Service**, **Topic**, and **Item** parameters.

**Control security level** specifies the minimum security level operators must have to gain access to this individual object, and thus control it.

The **Log events** option creates a permanent audit trail for the object—who did what and when. All adjustments of the switch are logged to disk, including the time the switch was flipped, the operator's account name, and the direction the switch was flipped. Refer to Chapter 7, *Logging Data and Events*, in the *Lookout Developer's Manual* for more information about event logging.

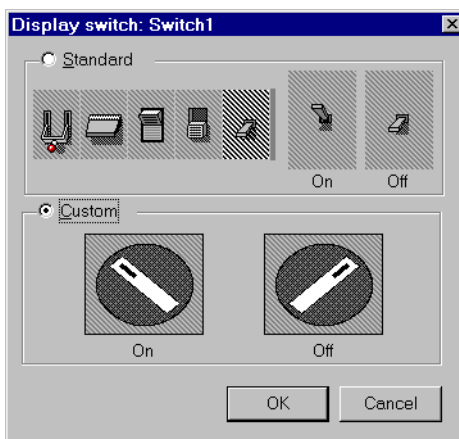

You can replace the standard switch types with custom graphic symbols. If you decide to use custom graphics, you must specify both symbol parameters, **On** and **Off**. Refer to Chapter 2, *Graphics*, in the *Lookout Developer's Manual* for more information about creating custom graphic symbols and the use of Transparent pixels.

## L3Switch Data Members

**Table 2-34.** L3Switch Data Members

Data Members	Type	Read	Write	Description
(implicit)	logical	yes	no	L3Switch Position
enable	logical	no	yes	If TRUE (the default), enables DDE. If FALSE, disables DDE. The default value is ON. This input is ignored for non-DDE L3TextEntry objects.
visible	logical	no	yes	When FALSE, the switch object cannot be seen on the display panel. When TRUE, the switch can be seen and controlled.

**Comments** If a switch with more than two positions is needed, use a Radiobutton object instead.

**Related Objects** [L3Pushbutton](#), [L3Pot](#), [Pushbutton](#), [Pot](#)

# L3TextEntry



**Note** L3 objects are for backward compatibility when using Lookout versions previous to Lookout 4.0.

With L3TextEntry you can manually enter textual notes with the keyboard. These notes may contain any combination of numeric and alphanumeric characters; however, the result of your entry is converted to a text value. Just like any other text expression in Lookout, your note can be logged to disk, connected to other data members that accept text signals, and so on. The note is saved and displayed as a single line entry—you cannot embed carriage returns into the message.

**Figure 2-46.** TextEntry Parameters Dialog Box

**Entry prompt** is the text that appears at the top of the text entry dialog box when an operator selects the text entry pushbutton.

**Text source** determines where the user-entered text resides. **Local** indicates the user-entered text lies within the object itself—on the control panel.



**Remote** indicates that the user-entered text resides in a remote source, such as a text expression or another TextEntry object.

Much like **Remote** TextEntry objects, **DDE** TextEntry objects get their values from a remote source. This is the option you use to tie the text to a cell in a spreadsheet, a database lookup table, or any DDE aware application—including a second copy of Lookout running on the network. Refer to Chapter 5, *Dynamic Data Exchange*, in the *Lookout Developer's Manual* for more information about **Service**, **Topic** and **Item**.



**Note** The last DDE parameters used on any object automatically become the default values for any new DDE object.

**Control security level** specifies the minimum security level operators must have to gain access to this individual object, and thus control it.

The **Log events** option creates a permanent audit trail for the object—who did what and when. When selected, all text entries in this object are logged to disk. Each entry includes the time of the entry, the operator's account name, and what entry was made. Refer to Chapter 7, *Logging Data and Events*, in the *Lookout Developer's Manual* for more information about event logging.

Lookout presents the following display parameters dialog box after you define the object. It lets you define the text font and presentation style.

## L3TextEntry Data Members

**Table 2-35.** L3TextEntry Data Members

Data Members	Type	Read	Write	Description
(implicit)	text	yes	no	Current, user-entered text
enable	logical	no	yes	If TRUE (the default), enables DDE. If FALSE, disables DDE. The default value is ON. This input is ignored for non-DDE TextEntry objects.

# LatchGate

LatchGate is latched on and off by two incoming signals. It retains the state of the signal that most recently went high, regardless of the state of the other signal. When the **Turn Off** signal transitions from OFF to ON, the LatchGate output goes OFF until the **Turn On** signal transitions from OFF to ON. The output signal does not change when either incoming signal transitions from ON to OFF. Both **Turn Off** and **Turn On** are logical expressions.

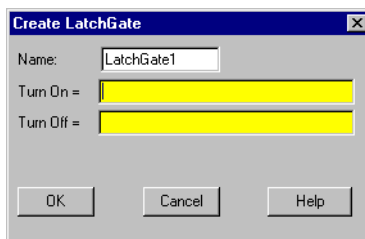

Figure 2-47. LatchGate Definition Parameters Dialog Box

## LatchGate Data Members

Table 2-36. LatchGate Data Members

Data Member	Type	Read	Write	Description
(implicit)	logical	yes	no	Logical output signal value

**Comments** Two pushbuttons connected to the **Turn On** and **Turn Off** expressions of a LatchGate create pushbutton start/stop controls for a pump or other device.

**Related Objects** [Flipflop](#)

# Loader

Use the Lookout Loader to load or unload a Lookout process in response to a logical trigger. Using a Loader object in conjunction with a Monitor object is how you create failover redundancy with Lookout. Refer to Chapter 10, *Redundancy*, in the *Lookout Developer's Manual* for more information about redundancy.



**Note** Unlike most Lookout objects, the Loader object is disabled while Lookout is in Edit mode.

You may notice that the information in the **State Information** and **Citadel Database** sections of this dialog box are the same as those areas in the **Create Process** dialog box and, in the case of the **Citadel Database** section, the **System Options** dialog box. Just as the **Citadel Database** section of the **Create Process** dialog box overrides the system database location settings for a particular process, any settings you make in the Loader object for database location or saving of state files override both system defaults and whatever settings you may have made when you created the process being loaded.

**Process Name** is the name that the process runs under when you open the **Process File**. You can use a process name other than the one used when the process file loaded was created.

**Process File** is the name of the file this Loader object will load when activated. You must enter a complete path to the file. You can specify a file from another computer on your network, but you must map the location on the remote computer as a network drive on your own computer first.

The **State Information** section of this dialog box lets you set where Lookout saves state files for the process just loaded, and under what name the files are saved.

Select **Save State File with Process File** to save the state file in the location where the process file was opened.

Select **Save State File in Lookout Folder** to save the state file in the Lookout folder of the copy of Lookout you are currently running. The state file name is the same as the process name.

Select the **Save Standby State File** check box to save one or more extra copies of the state file in a location of your choosing. Enter a complete path, including state file name, to each location you want to save a state file. If you are saving the state file to more than one backup or alternative location, separate the paths with the vertical bar (|) operator symbol.

Check the **Save State File(s) every NNNN (1-1440) minutes** option to set the frequency with which Lookout saves the state file. The Lookout default is 60 minutes.

The **Citadel Database** section sets the location of the Citadel database that Lookout logs data to for the process you load. If you check the **Use Default Values** check box, Lookout uses the default location set in the **System Options** dialog box of any instance of Lookout running the process.

If you enter a computer name and a path on that computer to a specific folder, Lookout logs data to that location on that computer, no matter what computer is running the process.

To designate a specific computer and path for your process to log data to, enter the fully qualified network name for the target computer in the **Computer Name** field, and the complete path to the target database directory in the **Citadel Database Folder** field.

**Load** is the logical signal you use to activate the Loader and load the process.

**Unload** is the logical signal you use to activate the Loader and unload the process you loaded earlier.

The Loader can only load one process at a time, and can only load a process to run inside the instance of Lookout currently running the process that contains the Loader.

To load multiple processes with one trigger, you must use multiple Loader objects.

## Loader Data Members

**Table 2-37.** Loader Data Members

Data Member	Type	Read	Write	Description
SaveWithProcess	logical	yes	no	When TRUE, Lookout saves a state file in the same location as the process file it contains the state for.
DatabaseComputer	text	yes	no	Sets the computer on which Lookout saves Citadel database files.
DatabaseFolder	text	yes	no	Sets the folder in which Lookout saves Citadel database files.
Failure	logical	yes	no	Monitor this data member to be alerted if a load attempt fails.
Failuretext	text	yes	no	Returns the reason for a failure to load the process designated by the loader.
Load	logical	yes	yes	Triggers the loader to load the designated process file.
ProcessFile	text	yes	no	Name of the process the loader loads when activated.
ProcessName	text	yes	no	Specifies the process name a loaded process runs under.
SavePeriod	numeric	yes	no	Sets how often, in minutes, that Lookout saves the state file for the loaded process.
SaveWithLookout	logical	yes	no	When TRUE, Lookout saves the state file in the Lookout directory, using <code>ProcessName</code> as the name for the state file as well.

**Table 2-37.** Loader Data Members

<b>Data Member</b>	<b>Type</b>	<b>Read</b>	<b>Write</b>	<b>Description</b>
StandbyFile	text	yes	no	Complete path to the location in which you want Lookout to save copies of the state file.
Unload	logical	yes	yes	Triggers the loader to unload the designated process.

## Loader Error Messages

### **Load: No process file specified**

Specify a process file in the **ProcessFile** field.

### **Load: No process name specified**

Name your process in the **ProcessName** field.

### **Load: Process already exists: *loadername.processname***

The process specified by your Loader object is already running under that name in this instance of Lookout. Only one process may run under each process name.

### **Load: No state file specified**

You must specify state file information for any process you load with a Loader object.

### **Load: Invalid process name**

You have chosen an invalid process name. Refer to the *Object Names* section in Chapter 4, *Using Lookout*, of the *Getting Started With Lookout* manual for more information about valid Lookout process and object names.

### **Load: Invalid database computer name**

The computer name you have entered in the **ComputerName** field is not registered as being a part of your Lookout network. Check the spelling of the name or register the computer through the Lookout Object Explorer or the Lookout Connection Browser.

### **Load: Invalid database folder**

Check the path you have entered in the **Citadel Database Folder** field to make sure the path you entered does exist on the computer specified in the **ComputerName** field.

**Load: Can't open process file *processfilename***

Lookout was unable to open the file *processfilename*. Check to see that the file exists in the specified location and has not been corrupted.

**Unload: No process name specified**

Enter the name of the process you want to unload in the **Process Name** field.

**Unload: Process not found**

Lookout must be running a process with the name specified in the **Process Name** field for the Loader to unload a process. If no process with the specified name is running when the Loader attempts to unload a process, Lookout returns this error message.

# Mailer

Use the Mailer object to send e-mail messages to one or more recipients.

**Recipients** is the list of people that will receive the **Message**. Enter a list of e-mail addresses separated by commas. As with other strings used in Lookout, you should enclose the entire list with double quotes.

The **Subject** field is the subject line of the e-mail.

Enter the body of the message in the **Message** field. Use the pipe (|) character to force new lines in the message. To make the e-mail interactive, connect the **message** parameter to a TextEntry object, which now has multiple line entry capability.

Send the e-mail manually by connecting a switch to the **Send** parameter, or automatically by entering an expression that evaluates to TRUE when specific conditions are met.

Select **Generate event on successful send** to set Lookout to report when the Mailer object succeeds in sending your message.

Select the **Word wrap message** option to wrap the message at 70 characters

Select **Buffer unsent messages** to set Lookout to store messages that were not successfully sent. If you select this option, Lookout will try to send the mail message the number of times specified in the **Retry attempts** field.



Lookout will retry at the interval specified in the **Retry delay** field. If you set Retry attempts to 5 and Retry delay to 10, Lookout will make five tries to send the message, one try every ten minutes. After the fifth time Lookout removes the message from the buffer.

Each retry attempt generates an alarm if Lookout is not able to send the message.



**Note** Lookout buffers mail that can not be sent for reasons that might resolve within a reasonable period of time, such as the mail server being down or extremely busy. If your mail server returns a message that mail is undeliverable for some reason, Lookout discards the mail without buffering it.

Enter the e-mail address for people to respond to in replying to your message in the **From address** field.



**Note** There are some mail sending errors that can not be caught at the SMTP level, such as a misspelled recipient address. Such mail will appear to have sent successfully, because Lookout has no way of detecting this circumstance. When the mail is ultimately recognized as undeliverable, an "Undeliverable message" E-mail is sent to the return address. The SMTP server, not the mailer object does this. For this reason, enter a valid e-mail address in the **From address** field as an extra safeguard.

Enter the name of your **SMTP server**. SMTP is an internet protocol. The Mailer object sends mail to internet e-mail addresses only. If you do not know the name of your mail server, consult your system administrator or ISP (Internet Service Provider).

**Timeout** is how long Lookout waits for a response from your SMTP server before buffering or discarding a message.

**Alarm priority** determines the priority level of the alarms generated by the Mailer object.

## Mailer Object Data Members

**Table 2-38.** Mailer Data Members

<b>Data Member</b>	<b>Type</b>	<b>Read</b>	<b>Write</b>	<b>Description</b>
attachment	text	no	yes	Connect to a TextEntry object or an expression containing a file path to a file on your computer. That file will be attached to the e-mail. Send multiple attachments by using a comma-separated lists of path names. Notice that sending a large file can take longer than sending a short message. If you intend to use this feature to send large files, increase your timeout parameter accordingly.
CommFail	logical	yes	no	Object-generated signal that is on if your mail could not be sent.
from	text	no	yes	E-mail return address displayed in the message.
message	text	no	yes	The body of the message.
recipient	text	no	yes	E-mail addresses of recipients. This can be a comma-separated list.
send	logical	no	yes	The mailer sends the e-mail when the connection to this data member goes TRUE.
subject	text	no	yes	The subject line of the e-mail.

# Maximum

Maximum actively calculates the maximum value of **Data** over time. Maximum is only active when the **Enable** expression is TRUE. It resets to zero when the **Reset** expression transitions from OFF to ON. Maximum also maintains an array of up to 35 previous maximum values. If **Enable** is left blank, the object always actively calculates the maximum. **Data** is a numeric expression while **Reset** and **Enable** are logical expressions.

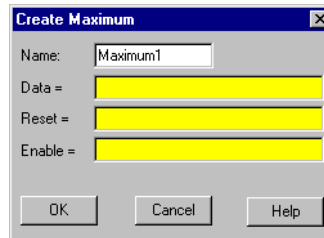

**Figure 2-48.** Maximum Configuration Parameters Dialog Box



**Note** Maximum does not have a display parameters dialog box. However, you can easily display Maximum by referencing it in an expression.

## Maximum Data Members

**Table 2-39.** Maximum Data Members

Data Members	Type	Read	Write	Description
(implicit)	numeric	yes	no	Current maximum value
1 – 35	numeric	yes	no	Previous maximum values. Signal 1 is the most recent prior maximum since the Reset expression went high.
DataReset	logical	no	yes	Upon transition from FALSE to TRUE, resets to zero all data members—including the current maximum value and all previous maximum values.

**Comments** The **Reset** interval could be a regular pulse interval created by a TimeOfxxxx timer, so that the pulse is synchronized to the top of the hour or day. For example, if you want to calculate the daily maximum flow rate, use the output signal from a TimeOfDay timer or a daily Spreadsheet object to reset the maximum calculation at the beginning of each day.

**Related Objects** [Average](#), [Minimum](#), [Sample](#), [SampleText](#)

# Minimum

Minimum actively calculates the minimum level of **Data** over time. Minimum is only active when the **Enable** expression is TRUE. It resets to zero when the **Reset** expression transitions from OFF to ON. Minimum also maintains an array of up to 35 previous minimum values. If **Enable** is left blank, the object is always actively calculating the minimum. **Data** is a numeric expression while **Reset** and **Enable** are logical expressions.

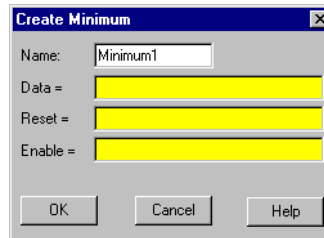

**Figure 2-49.** Minimum Configuration Parameters Dialog Box



**Note** Minimum does not have a display parameters dialog box. You can easily display the Minimum value referencing it an expression.

## Minimum Data Members

**Table 2-40.** Minimum Data Members

Data Members	Type	Read	Write	Description
(implicit)	numeric	yes	no	Current minimum value
1 – 35	numeric	yes	no	Previous minimum values. Signal 1 is the most recent prior minimum since the Reset expression went high.
DataReset	logical	no	yes	Upon transition from FALSE to TRUE, resets to zero all data members—including the current minimum value and all previous minimum values.

**Comments** The **Reset** interval could be a regular pulse interval created by a TimeOfxxxx timer, so that the pulse is synchronized to the top of the hour or day. For example, if you want to calculate the daily minimum flow rate, use the output signal from a TimeOfDay timer or a daily Spreadsheet object to reset the minimum calculation at the beginning of each day.

**Related Objects** *Average, Maximum, Sample, SampleText*

# Monitor

The Lookout Monitor object is integral to Lookout redundancy. The Monitor object maintains a connection with a data member in any process you want to watch from another computer or process. If the data flow from that source stops, the Monitor signals the halt, allowing you to respond.

Using a Monitor object in conjunction with a Loader object is how you create failover redundancy with Lookout. Refer to Chapter 10, *Redundancy*, in the *Lookout Developer's Manual* for more information about redundancy.

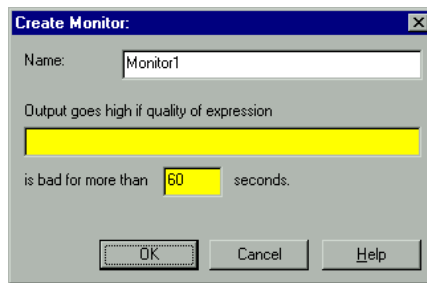

In the **Output goes high** field enter a data member in the process you want to monitor. If the data quality of that expression goes bad for more than the number you enter in the **seconds** field, the monitor goes high (TRUE), letting you know there is a problem with the process.

## Monitor Data Members

**Table 2-41.** Monitor Data Members

Data Member	Type	Read	Write	Description
(implicit)	logical	yes	no	Goes TRUE when the data member the Monitor is watching cannot be accessed after a specified length of time.
Delay	numeric	yes	yes	How long to delay before the output goes high, or TRUE.
Status	text	yes	no	Reports the status of the monitored data point.

## Mouse

The Lookout Mouse object is a special use object that reports to location of the mouse cursor on your Lookout panel. Create a mouse object using the **Create Mouse** dialog box, as shown in the following figure.

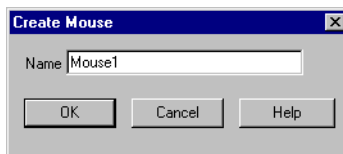

When enabled, the mouse object reports the X and Y coordinate locations of the mouse cursor on your computer screen as long as the mouse is over the Lookout Window. The mouse is easiest to use when the Lookout windows is maximized.

## Mouse Data Members

**Table 2-42.** Mouse Data Members

Data Member	Type	Read	Write	Description
Enable	logical	yes	yes	When true, data on mouse location and button state is reported through the readable data members.
LeftButton	logical	yes	no	Reports click status of the left mouse button.
RightButton	logical	yes	no	Reports click status of the right mouse button.
X	numeric	yes	no	Reports Y-coordinate location of the mouse cursor on your computer screen inside your Lookout window.
Y	numeric	yes	no	Reports Y-coordinate location of the mouse cursor on your computer screen inside the Lookout window.



# Multistate

Multistate displays different graphics on a control panel as dictated by the values of **Conditional expressions**. You can use up to six **Graphic files**, but at least one is required. Multistate determines which graphic to display based on the order and current status of your **Conditional expressions**. If several **Conditional expressions** are true at once, Multistate displays the graphic associated with the first true expression.

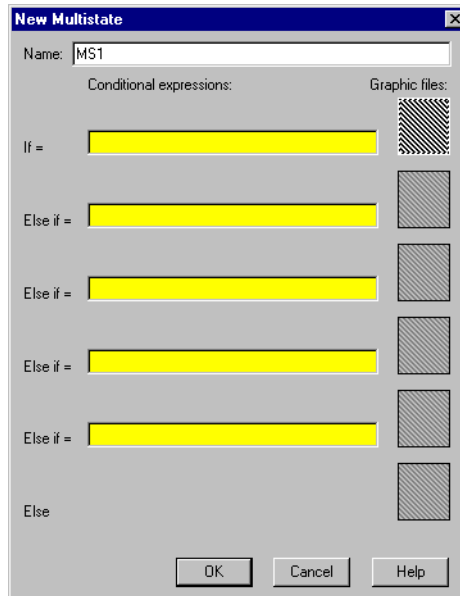

**Figure 2-50.** Multistate Configuration Parameters Dialog Box

**Conditional expressions** must result in logical values (TRUE or FALSE). Refer to the [Animator](#) section for more information about constructing logical statements. Double-click in a **Graphic file** box to select the graphic you want to use.



**Note** If you use both `.wmf` and `.bmp` images in graphic selections for the Multistate, the `.wmf` images will take the size of the largest `.bmp` image, and you will not be able to resize them. The `.bmp` images will not resize.

## Multistate Data Members

**Table 2-43.** Multistate Data Members

<b>Data members</b>	<b>Type</b>	<b>Read</b>	<b>Write</b>	<b>Description</b>
graphic1-graphicN	numeric	yes	no	Denotes which display of this object will appear on an HTML report. Only one display is available for the ActiveX object.

**Comments** By creating several graphic images that depict a sequence of events, Multistate can be used to create animation sequences on control panels such as hydraulic pistons moving back and forth. A more typical use of Multistate is for three-color pilot lights, where green represents running, red represents stopped, and yellow represents failed, for example.

For smooth, high speed animations, use the Animator object.

**Related Objects** [Animator](#)

# Neutralzone

Neutralzone is an ON/OFF Controller. It functions the way a home air conditioning thermostat does; if the temperature rises above a certain level, the `above` data member goes TRUE (turning the A/C on). When it drops below a lower temperature, the `below` data member goes TRUE (turning the A/C off).

When the incoming **Signal** value rises above both **Low limit** and **High limit**, the data member `above` turns on, and the data member `below` turns off. When the incoming **Signal** value drops below both **Low limit** and **High limit**, `above` turns off, and `below` turns on. The `above` and `below` data members do not change state when the signal value falls back within the two limits (within the neutral zone). **Signal**, **High limit**, and **Low limit** are all numeric expressions.

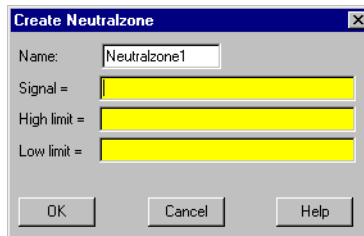

**Figure 2-51.** Neutralzone Definition Parameters Dialog Box

The previous discussion assumes numeric constants for both limits. However, you could use variable setpoint signals from Pot objects so an operator could dynamically adjust Neutralzone behavior.



**Note** Neutralzone does not have a display parameters dialog box. You can easily display the result of Neutralzone output signals by referencing its data members in an expression.

## Neutralzone Data Members

**Table 2-44.** Neutralzone Data Members

Data Members	Type	Read	Write	Description
above	logical	yes	no	ON if signal is greater than both limits, OFF if signal is less than both limits, and does not change if signal is between both limits
below	logical	yes	no	ON if signal is less than both limits, OFF if signal is greater than both limits, and does not change if signal is between both limits

**Comments** You can use this object to turn pumps on and off or open and close valves based on line pressures or tank levels. Neutralzone objects prevent pumps from cycling on and off around a single setpoint, just as an air conditioning thermostat prevents your home air conditioner from incessantly starting and stopping.

Often the term deadband is mistakenly used to describe a neutral zone. However, deadbands refer to the amount of change a numeric value must travel in the reverse direction before the output numeric value begins to change.

## Numeric Format

At this time use the Numeric Format object class to control the numeric format of data you export from Lookout to your HTML report page.

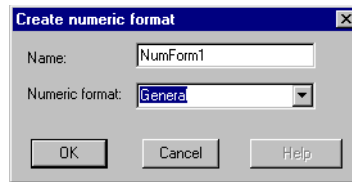

When you create this object you set the numeric format as you would for any Lookout numeric display. You then connect the NF data members, such as `valueNF`, from the Report object to the single data member, `format`. Output from the corresponding item data member will take the format you chose when it appears on an HTML report page.



**Note** Numeric Formats are represented internally in Lookout by a number. This object outputs that number for the selected format, to be used by other Lookout objects.

## Numeric Format Data Members

**Table 2-45.** Numeric Format Data Members

Data Members	Type	Read	Write	Description
Format	numeric	yes	no	Use to set the numeric format of a Lookout number.

# OneShot

---

OneShot is an adjustable delay timer. When **On/off signal** transitions to on, the output signal goes TRUE and the **Timer delay** begins to count down. At the end of the delay countdown, the output signal goes FALSE.

Unlike the Interval timer, the OneShot timer output remains on for the **Time delay** period even if **On/off signal** goes FALSE. So a OneShot timer requires only a momentary signal to begin the **Timer delay** period. Pulsing the **On/off signal** during the time delay period does not extend the time delay period of a OneShot timer.

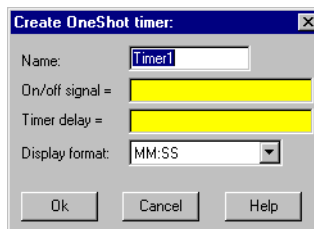

**Figure 2-52.** OneShot Definition Parameters Dialog Box

The **On/off signal** is a logical expression while Timer delay is a numeric expression. Normally, this is a simple time constant such as 0:20 (twenty seconds). Refer to the *Numeric Data Members* section of Chapter 2, *How Lookout Works*, of the *Getting Started with Lookout* manual for more information about time constants.

**Timer delay** can range from 0.0 seconds to several years. The effective resolution is 0.1 seconds over the entire range.

The object is represented on a control panel by showing the time delay remaining in the format defined by the **Display format** parameter. It is updated approximately once per second. If the delay period has expired, it shows **OFF**.

## OneShot Data Members

**Table 2-46.** OneShot Data Members

Data Member	Type	Read	Write	Description
(implicit)	logical	yes	no	Logical timer value
CommFail	logical	yes	no	Object-generated signal that is on if Lookout cannot communicate with the device.

**Comments** You can use the OneShot timer to hold a valve open for a set period of time after a pushbutton is pressed, or to prevent pump starts from occurring too rapidly in succession.

**Related Objects** [DelayOff](#), [DelayOn](#), [Interval](#), [Pot](#), [TextEntry](#)

# Pager

Pager is an object class Lookout uses to contact a numeric or alphanumeric pager through a modem, sending a message to the pager.

The 'Create Pager' dialog box for a Numeric Only pager contains the following fields and options:

- Name: Pager1
- Pager type: Numeric Only
- Pager number = "555-5555"
- Message = "Lookout numeric Page 123-4567"
- Numeric Only parameters:
  - Delay: 12 seconds
- Baud rate: 1200
- Serial port: COM1
- Communication alarm priority: 8
- Buttons: OK, Cancel, Help

**Figure 2-53.** Numeric Only Pager Definition Parameters Dialog Box

The 'Create Pager' dialog box for an Alphanumeric pager contains the following fields and options:

- Name: Pager1
- Pager type: Alphanumeric
- Pager number = "555-5555"
- Message = "Lookout numeric Page 123-4567"
- Alphanumeric parameters:
  - Terminal number: 89226068
  - Retry attempts: 4
  - Receive timeout: 2000 msec
- Baud rate: 1200
- Serial port: COM1
- Communication alarm priority: 8
- Buttons: OK, Cancel, Help

**Figure 2-54.** Alphanumeric Pager Definition Parameters Dialog Box

**Pager type** determines whether the Pager object operates in numeric only or alphanumeric mode. A detailed description of the operation of these two modes follows.



**Pager number** is the phone number of the pager you want to contact. When the Pager object is in **Alphanumeric** mode, this number corresponds to the pager ID number.

**Message** is the message you want to send to the pager. Notice that in **Numeric Only** mode only numeric characters are sent.

**Delay** is how long the Pager object waits after dialing the pager number before it dials the message number. This parameter is valid in **Numeric Only** mode only.

**Terminal number** is the phone number of the remote paging terminal you want to contact. This parameter is valid in **Alphanumeric** mode only.

**Retry attempts** specifies the consecutive number of times Lookout attempts to establish communications with a device if it is not getting a valid response. After it tries the number of **Retry attempts** specified, the Pager object generates an alarm and releases the COM port. Refer to Chapter 3, *Serial Port Communication Service*, in the *Lookout Developer's Manual* for more information. This parameter is valid in **Alphanumeric** mode only.

**Receive timeout** is the time delay Lookout uses in waiting for a response from a device before retrying the request. This parameter is valid in **Alphanumeric** mode only.

**Baud rate** indicates the baud rate Lookout uses to communicate with the modem and paging terminal.

**Serial port** specifies which COM port Lookout uses to communicate with your modem. You must have this COM port configured as dial-up under **Options»Serial Ports**.

**Communication alarm priority** determines the priority level of alarms generated by the Pager object. You can relate such alarms to communications with the modem or with the remote paging terminal.

## Pager Data Members

Table 2-47. Pager Data Members

Data Member	Type	Read	Write	Description
Message	text	no	yes	Pager message
Phone	text	no	yes	Individual pager phone number or Page ID number
Send	logical	no	yes	Sends the message on transition from FALSE to TRUE

## Pager Object Modes

### Numeric Only

In **Numeric Only** mode, the Pager object establishes a connection with your local modem. Once this connection has been established and the pager number dialed, the Pager object waits for the time specified by **Delay**, then dials the number that is the message. Because the `Message` data member is a text value, the Pager object in **Numeric Only** mode omits any non-numeric characters from the message when it is sent.

### Alphanumeric Mode

In **Alphanumeric** mode, the Pager object actually establishes a connection with a remote paging terminal, then transmits an alphanumeric message using Telocator Alphanumeric Protocol (TAP) version 1.8. TAP is an industry standard protocol for paging terminals that accept alphanumeric pages. Alphanumeric messages are limited to 250 characters. The text value in the `Message` data member will be truncated to this length if it is longer.

### Pager Serial Port Settings

Notice that there are two different retry settings that affect the operation of the Pager object in **Alphanumeric** mode. The retry settings in the Pager object dialog box govern serial communications with the remote paging terminal. This means that after the two modems have connected and finished handshaking, and the serial transaction is underway, each individual frame is timed by the **Receive timeout** setting, and retried the number of times specified by **Retry attempts**.

These retry settings will not dial the phone number again if the remote paging terminal for some reason does not answer or is busy, which happens occasionally. This setting and other important modem settings (including the AT initialization string that the Pager object must use on your modem) can be found in **Option»Serial Ports**, and should be chosen carefully. These settings are important in both Pager object modes.



**Note** You may have to increase your **Receive Gap** setting from its default of 5 to something closer to 20 or 25. You must also have your COM port configured as dial-up.

## Pager Queueing

The Pager object queues up to 10 messages in either mode. If the object is in the process of sending out a page and the `Send` data member goes high again, the current value of the `Message` data member will be queued and sent out when the Pager object has time. Messages that are already in the queue will not be duplicated.

## Pager Status Messages

### Paging terminal refused logon

Alphanumeric only error code

### Paging terminal forced disconnect

Alphanumeric only error code

### Paging terminal NAKed block transmission

Alphanumeric only error code

### Paging terminal abandoned block transmission

Alphanumeric only error code

### No response within timeout period

This means that the modem is not responding to Lookout requests.

### Queue full

The paging queue currently has 10 pages in it, and will not accept any more until at least one of those pages is successfully sent.

### Garbled response

A response from the modem was corrupted or in an unrecognizable form.

# Panel

Panel is a unique object class that accepts display members of other objects. Panels (Control panels) are a window into your process you can use to monitor and control your system by flipping switches, depressing pushbuttons, and turning knobs.

There is no limit as to the number of control panels you can create in Lookout or the number of objects or graphics that you can display on a given panel. Control panels can be any size, and you can display them within the Lookout workspace in various states (maximized, normal, minimized).

Create control panels with the **Object>Create...** command or with the **Insert>Control panel...** command. Both commands deliver the same result.

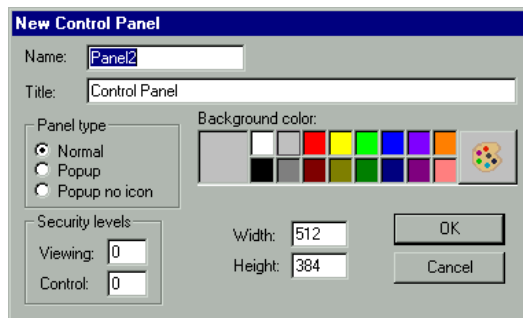

**Figure 2-55.** Panel Definition and Display Parameters Dialog Box

There are three distinct panel types: **Normal**, **Popup**, and **Popup no icon**.

A **Normal** control panel can be maximized, normal size, or minimized within the Lookout workspace. When you activate a **Normal** panel it appears at the size defined by its **Height** and **Width**. When you maximize a **Normal** panel, it fills the Lookout workspace. When you minimize a **Normal** panel it appears as an icon. The **Normal** option is typically selected for full-sized control panels.

**Popup** control panels can either be in a popup state or minimized (they cannot be maximized). When you activate a **Popup** panel it appears at the size defined by its **Height** and **Width**. When a Popup control panel is activated, it remains on top of all other panels until it is minimized. When you minimize a **Popup** panel it appears as a bar at the bottom of the Lookout screen.

**Popup no icon** control panels are identical to **Popup** panels except they are not represented by icons when minimized. When you minimize a **Popup no icon** panel it disappears from the Lookout workspace.



**Note** Because **Popup no icon** control panels are not represented by icons, they use less memory. (Microsoft Windows allocates a fixed amount of memory to each icon.) If you are experiencing memory problems when running a Lookout application that has many control panels, consider converting your **Popup** panels to **Popup no icon**.

Normal panels and Popup panels can be chosen by selecting their icon, using the **Window** menu command. **Popup no icon** control panels cannot; they can only be accessed by triggering their `activate` data member.

The **Security levels** settings are globally applied to a given control panel. The **Control** security level works in conjunction with all individual object security levels on that panel. The higher security level of the two is used to determine if an operator has control over the object. For example, consider a single Switch object with a security level of 4 that is displayed on two panels. The first panel has a control level of 6 and the second panel has a control level of 2. Only level 6 and higher operators are able to flip the switch on the first panel; however, level 4 and higher operators have control over the same switch on the second panel.

**Viewing** security can hide entire control panels from low level operators. This parameter affects the entire control panel. As an example take a control panel with a viewing security level of 6. If a level 5 (or lower) operator logs on, he is unable to see the control panel. In fact, he does not even know it exists because it is not listed in the **Window** menu and it is not shown as an icon. If a level 6 (or higher) operator logs on, the control panel instantly becomes available for display. This feature is useful for hiding panels that are rarely used or that contain sensitive information.

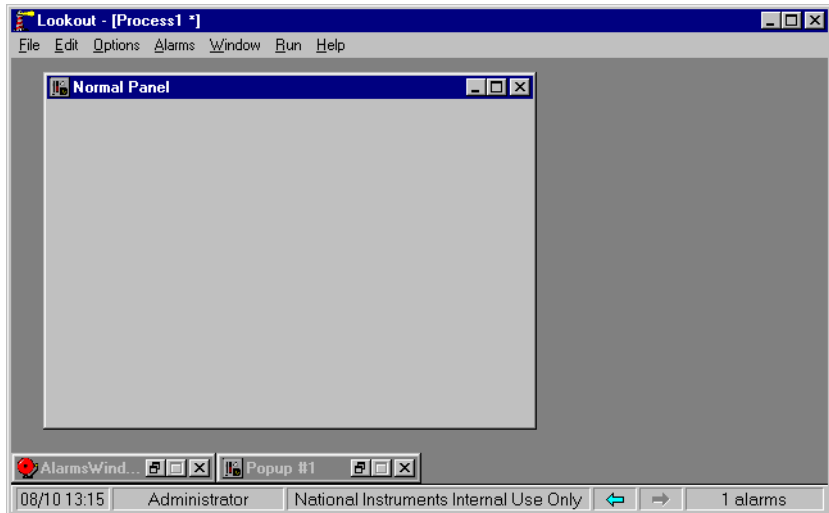

This example shows a **Normal** control panel in a normal state and a **Popup** control panel in a minimized state. The **Normal** panel could easily be minimized or maximized by hitting the appropriate arrow button.

The following example is a typical scenario involving full screen control panels with multiple popup panels displayed at once.

This configuration maximizes the amount of information that you can display at once; and it allows you to have any number of different combinations of control panels displayed on your monitor.

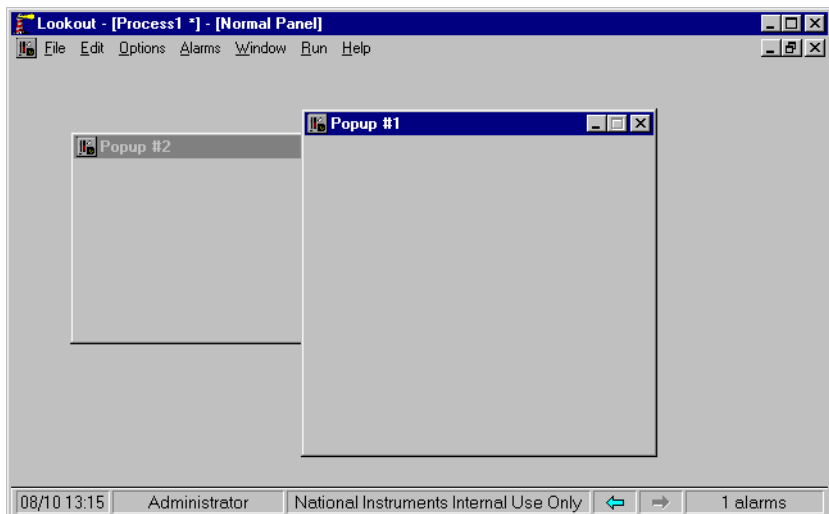

This example displays a **Normal** control panel in a maximized state and two **Popup** control panels in a “popped up” state.

## Manipulating Panels

Lookout control panels utilize the Microsoft standard Multiple Document Interface (MDI) techniques. You manipulate Lookout windows the same way you do other windows in the Microsoft Windows environment.

## Panel Switching

It is common to have several or even dozens of control panels. Creating a methodology for moving between your panels can be as simple or as elaborate as you want. One effective method utilizes pushbuttons that invoke other control panels. You connect the pushbutton output signal to the activate or maximize data member of the control panel(s) you want to affect. When the button signal goes high the respective panel(s) appear.

The following example shows a single pushbutton and X with its output signal connected to two **Popup** control panels. The pushbutton is inserted on a third maximized panel.

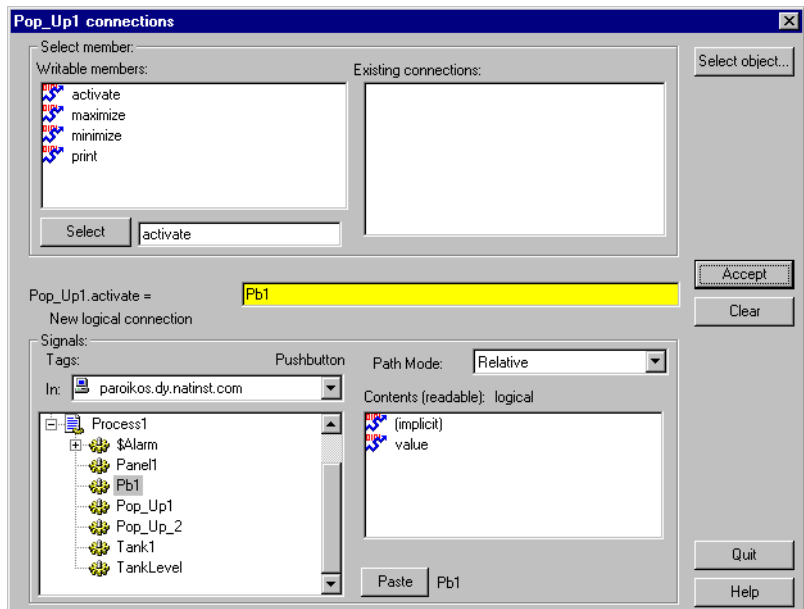

When you toggle out of Edit Mode and depress the button, both **Popup** control panels instantly appear, as shown in the following illustration. Of course you could have connected the pushbutton to another **Normal** panel instead, and it would have appeared as the new maximized panel.

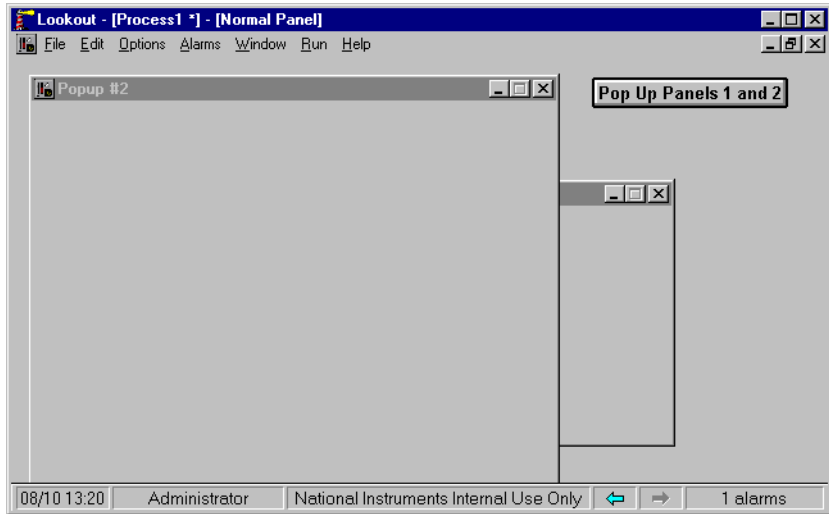

As you can imagine, there is no limit to the number of connections between various signals and control panels. In fact, you can create complex expressions/alarms that automatically call up specific control panels.

Another way to move between panels is through the use of function keys. Like the \$Keyboard object, each panel has its own set of data members representing the function keys F1 – F24. The following example shows the F2 data member of Panel1 connected to the activate data member of Panel2. The F2 data member of Panel2 is also connected to the activate data member of Panel3. This way an operator can depress F2 to page forward through several panels.

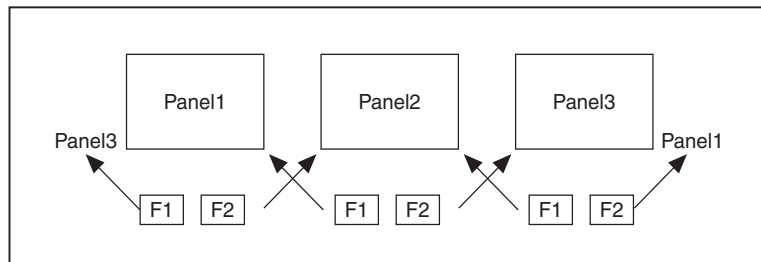



In similar fashion, the F1 data member of Panel3 is connected to the activate data member of Panel2 and the F1 data member of Panel2 is connected to the activate data member of Panel1. So now, `Panel2.activate = Panel1.F2 OR Panel3.F1`. An operator can depress F2 to page forward through the control panels and F1 to page back through the control panels.

## Special Considerations for “Home Panel”

To ensure users do not get lost when switching between panels, you might define one panel as your master control panel, or home panel or computer main menu. You could connect the activate data member of your home panel to `$Keyboard.Shift.F1`, or perhaps to a pushbutton object. If connected to the function key, any time the user presses `<SHIFT-F1>` (no matter what panel he or she is looking at), the home panel is called, returning the operator to a familiar control panel.

You might also want the home panel to maximize upon startup. If you have already created a pushbutton to call the home panel, you can connect it to the `maximize` data member.

The exclamation point (!) instructs Lookout to use the opposite of the pushbutton value. At startup, the pushbutton is not depressed so its value is `FALSE`. But because you are using the opposite of the pushbutton value, `Panel1.maximize` is `TRUE` at startup. Any time a user depresses `CallHomePb` after this connection is made, nothing happens until the pushbutton is released—at which time the panel is called.

## Programmable Control of Panels

Lookout allows you to control the size and location of your control panels programmatically.

The default size for a control panel is set with the parameters for height and width in the **New Control Panel** dialog box. The default location for a control panel is where the panel was located when it was last moved or resized in edit mode. Once you connect the size and location data members, however, these defaults are overridden by the values input through the connections.

Size and location values are interpreted as pixels. If your Lookout window, or your PC screen resolution, is smaller than the number of pixels input, your control panel may become too large to fit in the Lookout window, or may travel out of the window and be lost from view. Take the screen

resolution and the size of your Lookout window into consideration when setting limits on the location data member inputs.

## Panel Print

You can easily print a control panel using the **Print Panel** command. This function works equally well for both Normal and Popup panel types.

Print the contents of a panel by clicking on the panel control menu and then on **Print Panel**, or by connecting a logical expression to the `Print` data member of the desired control panel. A panel does not have to be visible to be printed.



**Note** Certain metafiles look different on the printed page than they do on the display screen. This means that parts of layered objects sometimes appear opaque on the screen, but translucent when drawn on paper.



**Note** When you print a **Normal** panel, it is printed at its defined **Height** and **Width** parameters. If you define a panel whose **Height** and **Width** are at the default  $400 \times 300$  pixel setting, maximize the panel, and then add graphic elements to the full panel, those elements outside of the default  $400 \times 300$  pixel range are not shown when the panel is printed. To print all the elements on a maximized panel, modify the **Width** and **Height** of the panel to match the full-screen dimension of the panel.

You can modify an existing control panel by toggling into edit mode and right-mouse clicking on its title bar. You can also modify a panel with the **Object»Modify...** menu command just like any other object.

## Screen Resolution and Lookout Graphics

Lookout graphics and control panels appear different, depending on the PC you are using and the resolution of your screen driver. When you position a graphic (or any other display element) onto a control panel, Lookout identifies the position you selected by recording the specific pixel position of the graphic. (A pixel is the smallest possible dot on the screen.) Lookout actually counts the number of pixels that the graphic is from the upper left-hand corner of the screen. When you subsequently recall a panel, Lookout knows the exact location to place the graphic.

The reason to bring this up is because different computer screen drivers have different screen resolutions. VGA screens are  $640 \times 480$  pixels. Super VGA screens typically range from  $800 \times 600$  pixels to  $1024 \times 768$  pixels. A panel created at  $640 \times 480$  pixel resolution does not fill the screen of a

1024 × 768 super VGA monitor. A panel created at 1024 × 768 pixel resolution will overflow the screen of a 640 × 480 VGA monitor.

It is best to create your panels using the display driver resolution of the computer on which you intend to run Lookout. If you are creating panels for use on multiple computers, consider developing panels using the display driver resolution of the most common resolution monitor (if you have a dozen Super VGA computers and one VGA computer, develop your panels in Super VGA, not VGA). You will then have to modify the panels slightly to fit on the less common resolution computer(s).

You can usually change the resolution of your screen from VGA to Super VGA by changing System Settings in Windows Setup. Refer to your *Microsoft Windows* manual for more information.

## Panel Data Members

**Table 2-48.** Panel Data Members

Data Members	Type	Read	Write	Description
<CTRL-F1> – <CTRL-F24>	logical	yes	no	Each of these 24 data members represent a function key, <F1> – <F24>—when pressed in conjunction with the <CTRL> key. Returns TRUE when the panel is active and its associated function key is pressed in conjunction with the <CTRL> key.
<F1> – <F24>	logical	yes	no	Each of these 24 data members represent a function key, <F1> – <F24>. Returns TRUE when the panel is active and its associated function key is pressed.
<SHIFT-F1> through <SHIFT-F24>	logical	yes	no	Each of these 24 data members represent a function key, <F1> – <F24>—when pressed in conjunction with the <SHIFT> key. Returns TRUE when the panel is active and its associated function key is pressed in conjunction with the <SHIFT> key.

**Table 2-48.** Panel Data Members (Continued)

<b>Data Members</b>	<b>Type</b>	<b>Read</b>	<b>Write</b>	<b>Description</b>
activate	logical	no	yes	Upon transition from FALSE to TRUE, calls control panel to focus or pop up.
active	logical	yes	no	Returns TRUE when the panel is the currently selected panel (i.e., it is active).
graphic1-graphicN	numeric	yes	no	Denotes which display of this object will appear on an HTML report. Only one display is available for the ActiveX object.
Height	numeric	yes	yes	Height of the dialog box in pixels. Once connected, this data member overrides the <b>Height</b> parameter entered in the <b>New Control Panel</b> dialog box.
maximize	logical	no	yes	Upon transition from FALSE to TRUE, maximizes control panel, replacing existing maximized control panel.
minimize	logical	no	yes	Upon transition from FALSE to TRUE, minimizes control panel to icon state.
print	logical	no	yes	Upon transition from FALSE to TRUE, sends the control panel to the Windows Print Manager.
Width	numeric	yes	yes	Width of the dialog box in pixels. Once connected, this data member overrides the <b>Width</b> parameter entered in the <b>New Control Panel</b> dialog box.

**Table 2-48.** Panel Data Members (Continued)

<b>Data Members</b>	<b>Type</b>	<b>Read</b>	<b>Write</b>	<b>Description</b>
X	numeric	yes	yes	Horizontal coordinate of the upper left corner of the control panel. The upper left corner of the Lookout window is the 0 point.
Y	numeric	yes	yes	Vertical coordinate of the upper left corner of the control panel. The upper left corner of the Lookout window is the 0 point.

# Pareto

The Pareto object class is one of the Lookout Statistical Process Control (SPC) tools and can play an important role in your Total Quality Management (TQM) program. This object class displays a frequency distribution of occurrences sorted by category so that you can identify the most frequently occurring anomalies or defects in your process.

The Pareto object class displays weighted and/or unweighted Pareto charts. The charts can be interactive, automatic, or a combination of both. An optional percentage line, showing cumulative percentage of factors, may be displayed. The number of factors to display, which may be less than the total number of factors defined, is user selectable. The chart background color, as well as the label, weight, and color of each factor, can be defined by the user.

The Pareto chart object definition dialog box is shown in the following illustration.

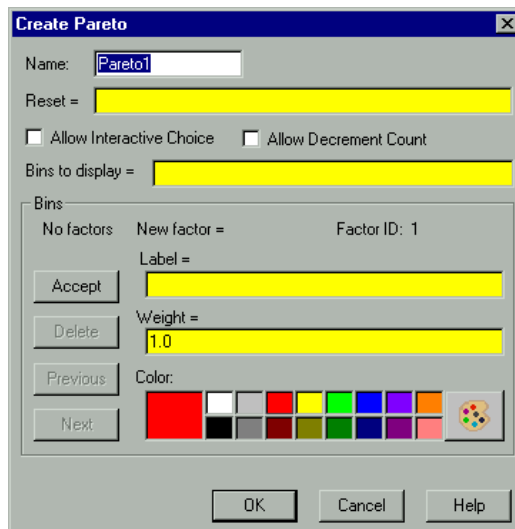

**Figure 2-56.** Pareto Definition Parameters Dialog Box

**Reset** is a logical expression that, on transition from FALSE to TRUE, resets all of the factor counts to zero.

Use **Allow Interactive Choice** to indicate whether the operator can increment (and possibly decrement) factor counts by clicking the mouse cursor on the Pareto chart object.

**Allow Decrement Count** indicates whether the operator can decrement the factor counts if you enable interactive choice.

**Bins to display** is the number of factor bins to display in the Pareto chart. This can be a numeric expression or a constant.

**Bins** parameters enable adding, modifying, or deleting factors to and from the Pareto chart. **Label** is the descriptive title for the factor. It can be a text constant or expression. **Weight** is the bias you can apply for a factor if you are going to display a weighted Pareto chart. It can be a numeric constant or expression. **Color** is the color of the bar for the factor. **Factor ID** is a number generated by the object to uniquely identify the current factor count when it is being saved to or restored from the Lookout state file. It is a visual indication to the user that a factor count is associated with a particular Factor ID, and not with the Label.

The Pareto display dialog box is shown in the following illustration.

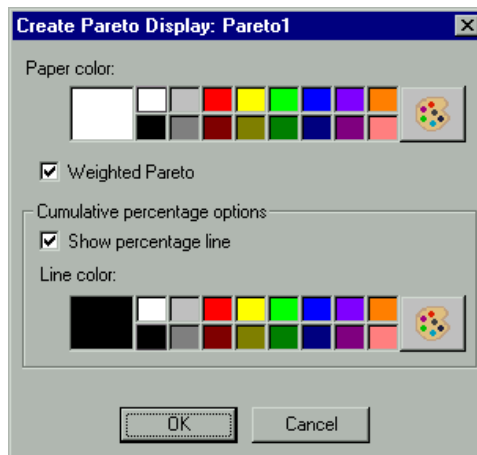

**Figure 2-57.** Pareto Display Parameters Dialog Box

**Show percentage line** determines whether a cumulative percentage line will be displayed in the color selected by **Line color**.

**Weighted Pareto** determines whether the Pareto is displayed as a weighted chart or an unweighted chart.

## Weighted or Unweighted Charts

Using the same Pareto object, you can display weighted or unweighted Pareto charts. An unweighted Pareto chart shows which factors occur most frequently. If the factors are of approximately equal importance, an unweighted chart is a good indication of trouble spots.

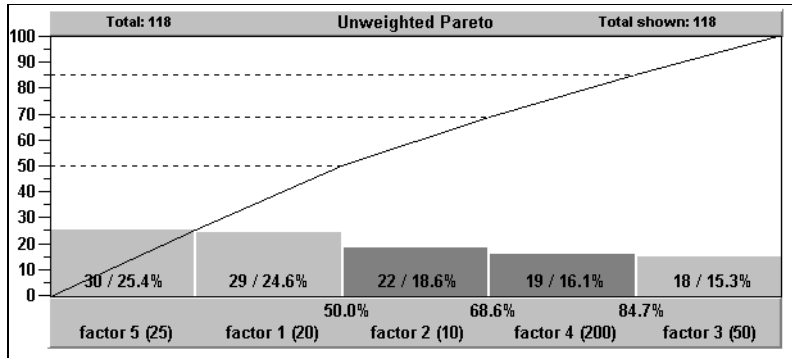

**Figure 2-58.** Unweighted Pareto Chart

If some factors are much more serious than others, using a weighted Pareto chart to ascertain the cost or exposure of a factor is a much more effective tool for identifying problem areas. For example, in the unweighted Pareto chart in Figure 2-58, factor 1 and factor 5 together account for 50 percent of the defect occurrences. However, as you can see on the weighted Pareto chart in Figure 2-59, factor 4 alone accounts for 60.8 percent of the total expense of all defects.



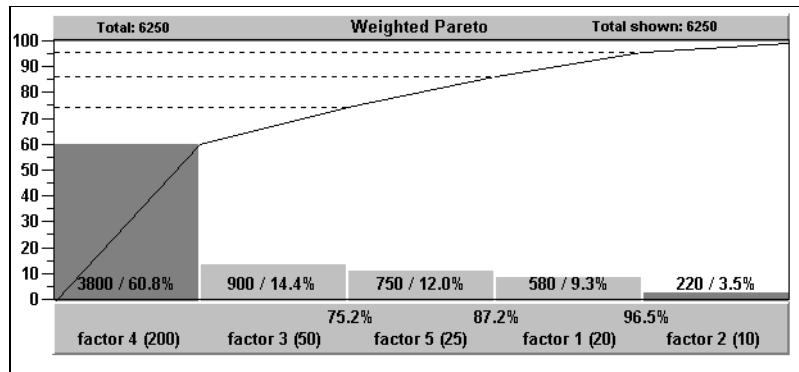
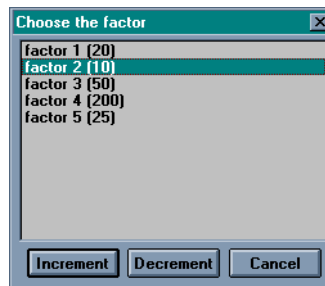

Figure 2-59. Weighted Pareto Chart

## Incrementing Factor Counts

You can use a Pareto chart to interactively or automatically increment factor counts. In fact, the object can accept any combination of automatic and interactive inputs.

If you select the **Allow Interactive Choice** option in the object definition dialog box, the operator can manually increment factor counts. To do this, the operator clicks the mouse cursor on the Pareto chart object. This pops up box that lists all the possible factors you can choose. The factor that the cursor is on when the operator clicks on the chart determines which factor is highlighted when the dialog box pops up. In this example, the mouse cursor was over the factor 2 bin.



If you select the **Allow Decrement Count** option in the object definition dialog box, the Decrement button is displayed in the pop-up, allowing the operator to decrement a factor count. Operators with a high enough security level can correct errors if necessary.

## Pareto Data Members

The Pareto object can use external connections to trigger the factor counts automatically. You can connect a pushbutton, an alarm, an expression, a PLC output, and so on, to a factor trigger to increment a factor count on a transition from FALSE to TRUE. The following table lists data members of the Pareto object class.

**Table 2-49.** Pareto Data Members

Data Members	Type	Read	Write	Description
count.sorted1 – 1000	numeric	yes	no	The count in the respective sorted-by-count factor bin.
count.weighted.sorted 1 – 1000	numeric	yes	no	The weighted count in the respective sorted-by-weighted-count factor bin.
count.weighted1 – 1000	numeric	yes	no	The weighted count in the respective unsorted factor bin.
count1 – 1000	numeric	yes	no	The count in the respective unsorted factor bin.
factor1 – 1000	logical	no	yes	On transition from FALSE to TRUE, increment the respective factor count by 1.
graphic1 - graphicN	numeric	yes	no	Denotes which display of this object will appear on an HTML report. Only one display is available for the ActiveX object.
label.sorted1 – 1000	text	yes	no	The label of the respective sorted-by-count factor bin.
label.weighted.sorted 1 – 1000	text	yes	no	The label of the respective sorted-by-weighted-count factor bin.
label1 – 1000	text	yes	no	The label of the respective unsorted factor bin.
percent.sorted1 – 1000	numeric	yes	no	The percent of the total count in the respective sorted-by-count factor bin.
percent.weighted.sorted 1 – 1000	numeric	yes	no	The percent of the total weighted count in the respective sorted-by-weighted-count factor bin.

**Table 2-49.** Pareto Data Members (Continued)

<b>Data Members</b>	<b>Type</b>	<b>Read</b>	<b>Write</b>	<b>Description</b>
percent.weighted 1 – 1000	numeric	yes	no	The percent of the total weighted count in the respective unsorted factor bin.
percent1 – 1000	numeric	yes	no	The percent of the total count in the respective unsorted factor bin.
total	numeric	yes	no	The total of all unweighted factor counts in all defined factors.
total.shown	numeric	yes	no	The total of all unweighted factor counts in all currently displayed factors.
total.shown.weighted	numeric	yes	no	The total of all weighted factor counts in all currently displayed factors.
total.weighted	numeric	yes	no	The total of all weighted factor counts in all defined factors.
visible	logical	yes	yes	When TRUE, the Pareto chart becomes visible on the control panel. When FALSE, it is invisible. The default value is TRUE.

# PID

The PID object compares a **Process Variable** to a **Setpoint**. If there is a difference, it calculates the error and adjusts its output to compensate until the **Process Variable** is equal to the **Setpoint**.

PID stands for Proportional-Integral-Derivative. These are three factors in the equation that can be applied against the calculated error. You specify **Gain** which is the proportional factor, **Reset** (the integral factor), and **Rate** (the derivative factor) to define how the object responds to the error.



**Note** The way in which the PID object responds to your process can vary greatly according to the parameters you enter and the process you are controlling. Any discussion regarding tuning of a PID loop falls outside of the topics addressed in this manual.

**Figure 2-60.** PID Definition Parameters Dialog Box

**Type** selects either positional control or velocity control. Detailed descriptions of both control modes are provided in the following sections.

**Process Variable (PV)** is typically the numeric signal from the field that you want to control. The PID loop equation does not expect this value to be normalized; rather the PID object performs the scaling of loop input and output values from engineering units.

**Setpoint (SP)** is typically the value of a Pot object, a constant numeric value, or the output signal from another PID object in a cascaded loop. Like the process variable, the setpoint is also scaled internally by the PID object.

**Setpoint Min** and **Max** are numeric constants that specify the range of *SP* and *PV* in engineering units.

**Manual Output** is a numeric parameter that specifies the output of the object when it is in manual mode; that is, when the **Automatic Enable** expression is FALSE. Users typically enter either a constant, or the name of a Pot object in this field.

**Output Min** and **Max** are numeric constants that specify the range of the object output signal. The output is often referred to as the *manipulated variable (MV)*.

**Sample Pulse** indicates the frequency at which the PID object executes. This parameter field can contain either a numeric constant or a logical variable. If you use a numeric constant (like 0 : 01 for one second), the object calculates a new output value at the defined frequency. If you use a logical variable, then the variable should pulse at some desired frequency. Any time the pulse transitions from FALSE to TRUE, the object calculates a new output value. It is very important not to over-sample your data. Start with a slow sample rate.

**Gain** ( $K_c$ ) is a numeric parameter that determines the overall sensitivity of the PID loop to changes in error. A gain value of 1.00 changes the proportional increment of the PID equation by 50 percent when there is a 50 percent change in error. A gain value of 0.25 changes the proportional increment by 12.5 percent with a 50 percent change in error.

**Reset** ( $T_i$ ) also referred to as integral time, is a numeric parameter that specifies the amount of time it takes for the integral sum increment of the PID loop equation to react to a given change in error. For example, if the error suddenly changes by 20% and reset = 0:10 (10 seconds), the integral increment of the PID loop increases at a rate of 0.5 percent per second until it has changed by 20 percent after 40 seconds. This 20 percent contribution is multiplied by the gain, so if the gain is 2.0, the integral term contributes 40% to the loop output in this example. In other words, the shorter the reset time, the faster the object output responds to a change in either *PV* or *SP*.

**Rate** ( $T_d$ ) also referred to as derivative time, is a numeric parameter that dampens loop response. It is calculated based upon the rate of change of *PV* and adds an increment to the output that attempts to anticipate and slow the change in *PV*. As an example, if *PV* is increasing by 10 percent per minute, and *rate* is 0:30 (0.5 minutes), the derivative increment is calculated as  $-(10\%/min. \times 0.5\ minutes) = -5\%$  (or  $-0.05$ ). So the derivative term would contribute  $-5\%$  to the output if the gain is 1.0.

**Automatic Enable** specifies whether the loop controller is operating in automatic mode or manual mode. When it is ON, controller is operating in automatic mode and the output signal is being calculated using the PID algorithm. In manual mode, the output signal is equal to the **Manual Output** input signal.

The PID object provides bumpless transfer from manual to automatic operation—when the controller is switched from manual to automatic, its output begins changing from the current manual output setting. Contrast this with a loop controller without bumpless transfer. When such a controller is in manual, the integral term continues to accumulate. When the controller is switched to automatic, the loop controller would immediately go to a high or low output.

**Add proportional increment** specifies whether the loop equation adds the proportional increment of the PID equation to *MV*. This value is typically ON.

**Freeze Enable** specifies whether the loop bias should be frozen or actively back-calculated when the controller output signal goes out of range. In either case, the loop controller is protected from integral wind-up, but if Freeze Enable is OFF (recommended setting), the bias is actively back-calculated to prevent controller overshoot when *PV* comes back into range.

The PID object protects against integral windup in one of two selectable ways: It either freezes the bias term when the controller output goes out of range, or it actively back-calculates the bias so the controller responds smoothly with less chance of overshoot when its output returns to range.

**Output Time** is a numeric constant that specifies the time domain of the controller output when operating in velocity mode. For example, if the object output controls a value with dimensions of inches per minute, output time would be 1:00 (one minute).

**Low Limit Enable** is used in velocity control mode. It is an optional logical signal that clips the PID output to a value greater than or equal to zero when TRUE. This input can be used to signal the controller that the low limit switch on the controlled device has been activated.

**High Limit Enable** is used in velocity control mode. It is an optional logical signal that clips the PID output to a value less than or equal to zero when TRUE. This input can be used to signal the controller that the high limit switch on the controlled device has been activated.

## PID Positional Control

When you select `Position`, the PID object calculates the output as follows:

$$MV = K_c(e_n + \text{integral sum}_n - T_d/dT(PV_n - PV_{n-1}))$$

where:

$dT$  = time increment between current and previous calc.

$MV$  = controller output (manipulated variable)

$K_c$  = controller gain (units: % output / % error)

$e_n$  = error at sample  $n$  (error =  $SP - PV_n$ )

$\text{integral sum}_n = \text{integral sum}_{n-1} + dT / T_i (e_n - e_{n-1})$  also called bias

$T_d$  = rate, or derivative time

$PV_n - PV_{n-1}$  = change in PV from previous to current calculation

## PID Velocity Control

The output of the velocity form of the PID equation is the velocity or rate of change of the output signal. The velocity form of the PID equation is the first derivative of the position form of the PID equation with respect to time, so the result is the rate of change of the controller position.

When you select `velocity`, the object calculates the output as follows:

$$dMV = MV_n - MV_{n-1} = K_c((e_n - e_{n-1}) + T_s e_n / T_i + T_d / T_s (PV_n - 2PV_{n-1} + PV_{n-2}))$$

where:

$MV$  = controller output position (manipulated variable)

$dMV$  = controller output velocity

$K_c$  = controller gain (units: % output / % error)

$e_n$  = error at sample  $n$  (error =  $SP - PV_n$ )

$T_d$  = rate, or derivative time

$PV$  = process variable

## PID Data Members

**Table 2-50.** PID Data Members

Data Members	Type	Read	Write	Description
Error	numeric	yes	no	This is the difference between the <b>Setpoint (SP)</b> and the <b>Process Variable (PV)</b> .
Output	numeric	yes	no	This is the PID controller output value, also called <i>MV</i> , or the manipulated variable. This value is either the result of the PID loop equation or the <b>Manual Output</b> , depending on the state of <b>Automatic Enable</b> .

**Comments** The proportional term of the PID equation contributes an amount to the output equal to the error multiplied by the **Gain**. This provides an immediate output compensation when the error value changes.

The integral term of the PID equation calculates a running total of the error summed (or integrated) over time—think of this increment as adding the area under the curve of a plot of error versus time. While *SP* is greater than *PV*, the integral term is increasing, and while *PV* is greater than *SP*, the integral term is decreasing. The sensitivity of the integral output is set by the gain and the reset variables. Integral action can be eliminated by setting **Reset** to a higher number. At least some Integral action is required, however, for the loop controller to operate properly with bias adjustment. If you do not use any Integral, you may experience offset, a condition in which the output is adjusted to compensate for the error, but not enough to correct the error.

The derivative term of the PID equation acts to dampen the change in *PV* by adding a negative value for a positive-going *PV* and a positive value for a negative-going *PV*. Because *PV* is subject to sudden small changes and signal noise in many process loops, derivative action can cause a loop to respond erratically. **Rate** can be set to 0, especially when initially tuning the loop, to eliminate derivative action. Derivative action dampens process loops that tend to oscillate around the setpoint and thus provide better loop response. Rapidly changing loops such as liquid flow control in a pipe may not benefit from derivative action, but more sluggish loops that tend to build



momentum, such as temperature control, benefit from derivative action by preventing overshoot and dampening oscillatory action.

# Pipe

Pipe displays different color rectangles (pipes) on a control panel as defined by the values of **Conditional expressions**. Pipe determines which color rectangle to display based on the order and current status of your **Conditional expressions**. If several **Conditional expressions** are TRUE at once, Pipe displays the color associated with the first TRUE expression. **Conditional expressions** must result in logical values.

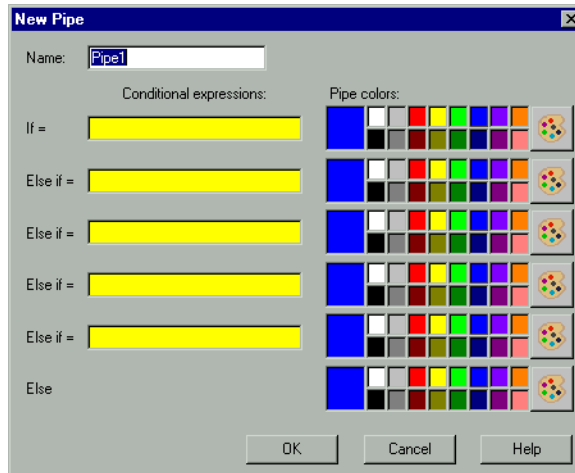

Figure 2-61. Pipe Definition Parameters Dialog Box

## Pipe Data Members

Table 2-51. Pipe Data Members

Data Members	Type	Read	Write	Description
graphic1 - graphicN	numeric	yes	no	Denotes which display of this object will appear on an HTML report. Only one display is available for the ActiveX object.

**Comments** You can easily create a complex piping network scheme (including changing colors) with a single Pipe object. Display the object on a control panel and copy the pipe display with the shift-drag method to create additional pipes with the same parameters. You can then move, resize, and group the pipes as you choose.

# Playwave

Playwave connects Microsoft standard wave form files (.wav) to events in Lookout. Playwave plays the audio file specified by **Wave file** when **Play when** transitions from off to on. **Play when** is a logical expression and might range from a simple pushbutton, to a digital input from a PLC, to an alarm generated in Lookout. You can also create your own custom audio files with various software products. Therefore, you can connect individual alarms to custom wave files to be played each time an alarm goes TRUE.

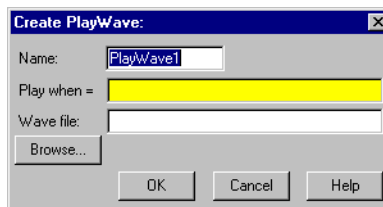

Figure 2-62. Playwave Definitions Parameters Dialog Box

## Playwave Data Members

Table 2-52. Playwave Data Members

Data Members	Type	Read	Write	Description
none	—	—	—	Playwave does not have any data members

**Comments** Many computers do not come equipped with quality speakers built in. If this is the case, your wave files may sound distorted or may even be inaudible. If you want to take advantage of the Playwave feature, you may need to buy additional hardware, in particular a Microsoft Windows compatible sound board (with Windows driver) and external speakers.

# Pot

Pot is a potentiometer that you use to change numeric setpoint values. You can display Pots on a control panel as a knob, vertical slider, horizontal slider, increment/decrement pushbuttons, or digital entry. You can also use Pots as multiple-position switches.

If you change the background color of a panel and add a Pot object displayed as a slider, its color is always gray. To change the background color of a Pot to match your panel, select the Pot object, then pick **Change»Background Color** from the menu.

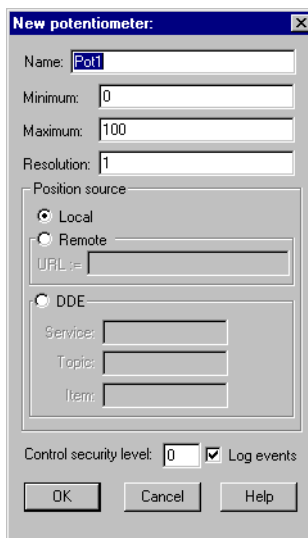

**Figure 2-63.** Pot Definitions Parameters Dialog Box

**Minimum** is the lowest value signal the pot will generate.

**Maximum** is the highest value signal the pot will generate.

**Resolution** is the smallest increment of change, or detent spacing the Pot supports.

**Position source** determines where the value of the Pot resides. **Local** indicates the value of the Pot lies within the object itself—on the control panel.

**Remote** Pots get their values from a remote source, often the register on a controller they are connected to. Adjusting the Pot changes the value in the register, and changing the value in the register adjusts the Pot. In effect, the Pot is tracking a remote value. This is especially useful when you want to prevent Lookout from changing the value of setpoints or registers upon initial startup, or reconnection of lost communication.

The **Remote** option calls for a URL to locate the data member you want to connect to. The URL field is green, and you cannot use a complex expression as a URL. If you need to use one RadioButton for several purposes, you can use a Symbolic Link to make a more complex connection than that possible with a URL.

You can right-click in the **URL** field and use the **URL Editor** dialog box to assemble the URL, in the same way you use the Lookout expression editor.

A remote position source connection is completely reciprocal. A change in your Lookout control changes the data member that control is remoted to. Any change in that data member also changes the control. It is not necessary, and is incorrect, to use the **Edit Connections** dialog box to connect a control object to its controlled data member.

Because the remote connection is reciprocal, you can only make such a connection to a data member that is either writable, or readable and writable.

When a process with remoted controls first opens, those controls take their initial values by following the URL to read the data members they are remoted to. The control will be covered by a red X to indicate that the remote connection is not functioning.



**Note** You should use **Remote** to connect a control in a client process to a data member in a server process. Connections inside a single process can be made using **Object>Edit Connections**.

Because complex expressions are read-only values, you cannot remote directly to them. For the same reason, you cannot remote one control to another control's (intrinsic) data member (though you can remote a control to another control's value data member).

Much like Remote Pots, **DDE** (Dynamic Data Exchange) Pots get their values from a remote source. This could be a cell in a spreadsheet, another DDE aware application, or a second copy of Lookout running on the network. The last DDE parameters used on any object automatically become the default values for any new DDE object.

**Control security level** specifies the minimum security level operators must have to gain access to this individual object, and thus control it.

The **Log events** option creates a permanent audit trail for the object—who did what and when. All adjustments of the Pot are logged to disk, including the time of the adjustment, the operator account name, and what adjustment was made.

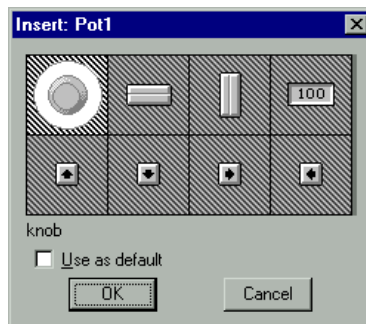

**Figure 2-64.** Pot Display Parameters Dialog Box



**Note** You can modify the background color on vertical and horizontal sliders with the **Change»Background color...** menu command. You can modify the font and font color of digital Pots using Change commands.

## Pot Data Members

**Table 2-53.** Pot Data Members

Data Member	Type	Read	Write	Description
(implicit)	numeric	yes	no	Current value
decrement	logical	no	yes	When this data member value transitions from FALSE to TRUE, the implicit value of the Pot object decreases by the Pot <b>Resolution</b> amount.

**Table 2-53.** Pot Data Members (Continued)

<b>Data Member</b>	<b>Type</b>	<b>Read</b>	<b>Write</b>	<b>Description</b>
enable	logical	no	yes	If TRUE (the default), enables DDE. If FALSE, disables DDE. The default value is on. This input is ignored for non-DDE TextEntry objects.
enterValue	logical	no	yes	Under specific circumstances, when this value transitions from FALSE to TRUE, pops up a <b>Enter new value</b> dialog box for an operator to use in entering a value for the Pot. See the note following the table for more detailed information.  The enterValue data member is designed for use under unusual circumstances, in particular when pointing devices are not available on a computer running Lookout. Because of its unusual operation, this data member should not be used unless it is necessary for hardware reasons.
graphic1-graphicN	numeric	yes	no	Denotes which display of this object will appear on an HTML report. Only one display is available for the ActiveX object.
increment	logical	no	yes	When this data member value transitions from FALSE to TRUE, the implicit value of the pot object increases by the <b>Resolution</b> amount.
reset	logical	no	yes	While this value equals TRUE, the control will be set to the value in resetvalue.
resetvalue	numeric	no	yes	Sets the value a control will take when the reset data member transitions from FALSE to TRUE.

**Table 2-53.** Pot Data Members (Continued)

<b>Data Member</b>	<b>Type</b>	<b>Read</b>	<b>Write</b>	<b>Description</b>
value	numeric	yes	yes	The current value of the control. If you have removed this control, then <code>value</code> is the current value of the position source.
visible	logical	no	yes	When <b>FALSE</b> , the Pot object cannot be seen on the display panel. When <b>TRUE</b> , the Pot can be seen and controlled.



**Note** When the `enterValue` input transitions from **FALSE** to **TRUE**, and if the Pot is visible, if Lookout is not in edit mode, and if the Pot has at least one digital display, the **Enter new value** dialog box pops up so an operator can input a value, just as if the operator had clicked on the digital display.

The numeric format and position used for the dialog box are based on the digital display for a Pot. Even if the panel containing the Pot digital display is inactive, the **Enter new value** dialog box will pop up. You can prevent this by predicating the `enterValue` input on the panel's `active` data member.

**Comments** Potentiometers are one of the most common control objects used in process controls. Using Pots, a plant operator can make setpoint changes with the mouse. Pots also work well as H-O-A switches. To create an HOA switch with a Pot, specify the minimum as 1, the maximum as 3, and the resolution as 1.

The increment and decrement data members enable quick connection of Pot objects to \$Keyboard and Panel function keys, and screen Pushbuttons. These are often used to control Pot objects when Lookout is running on an industrial PC platform that has restricted or no mouse functionality.



# Pulse

Pulse is a timer that generates a periodic pulse of a specified duration. When **On/off signal** transitions to ON, the output signal turns on for the pulse duration time and then turns off for the remainder of the period. The output signal immediately turns off when the **On/Off signal** goes low.

**Timer period** is the time interval for the full pulse cycle, and **Timer duration** is the width of each pulse. These parameters can range from 0.0 seconds to several years, with an effective resolution of 0.1 seconds over the entire range. **Timer duration** should always be less than **Timer period**.

The object is represented on a control panel by showing the time remaining before the output changes state. It is depicted in the format defined by the **Display format** parameter. It is updated approximately once per second. If the **On/Off signal** is FALSE, it shows OFF.

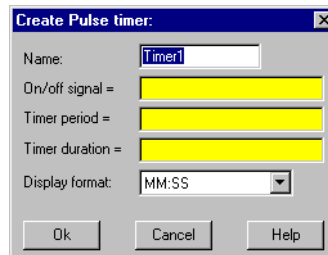

**Figure 2-65.** Pulse Definition Parameters Dialog Box

The **On/off signal** is a logical expression while **Timer period** and **Timer duration** are numeric expressions. Normally, these are simple time constants such as 0:20 (twenty seconds). Refer to the *Numeric Data Members* section of Chapter 2, *How Lookout Works*, of the *Getting Started with Lookout* manual for information about entering time constants.

## Pulse Data Members

**Table 2-54.** Pulse Data Members

Data Members	Type	Read	Write	Description
(implicit)	logical	yes	no	Logical timer value

**Comments** Pulse can be used to periodically open a valve for a specified time duration. It can also act as a flasher to turn text and graphic signals on and off for display purposes.

**Related Objects** [DelayOff](#), [DelayOn](#), [Interval](#), [OneShot](#), [TextEntry](#)

# Pushbutton

Pushbutton generates a logical signal for receipt by other objects. A pushbutton changes state when you position the cursor over it and press the mouse button, trackball, touchscreen, or space bar. The pushbutton remains depressed and the output signal remains high until you release the button. If a **Verify on** message is defined, the operator must first acknowledge the message, then the output signal goes high, *but only momentarily*.

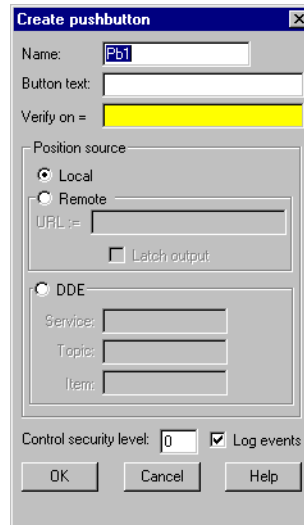

**Figure 2-66.** Pushbutton Definitions Parameters Dialog Box

**Button text** displays the specified text on the pushbutton.

Use **Verify on** to create a dynamic text expression to be displayed in a message dialog box. See Chapter 6, *Security*, in the *Lookout Developer's Manual* for more information on security.

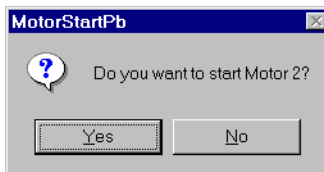

**Figure 2-67.** Verification Message Dialog Box

**Position source** determines where the value of the Pushbutton resides. **Local** indicates the value of the Pushbutton lies within the Pushbutton itself—on the control panel. If the pushbutton is not depressed its signal is OFF, if depressed its signal is ON.

**Remote** Pushbuttons get their values from a remote source, often the register in a controller they are connected to. Depressing the pushbutton changes the status of the register, and changing the status of the register depresses the pushbutton.

The **Remote** option calls for a URL to locate the data member you want to connect to. The URL field is green, and you cannot use a complex expression as a URL. If you need to use one RadioButton for several purposes, you can use a Symbolic Link to make a more complex connection than that possible with a URL.

You can right-click in the **URL** field and use the **URL Editor** dialog box to assemble the URL, in the same way you use the Lookout expression editor.

A remote position source connection is completely reciprocal. A change in your Lookout control changes the data member that control is remoted to. Any change in that data member also changes the control. It is not necessary, and is incorrect, to use the **Edit Connections** dialog box to connect a control object to its controlled data member.

Because the remote connection is reciprocal, you can only make such a connection to a data member that is either writable, or readable and writable.

When a process with remoted controls first opens, those controls take their initial values by following the URL to read the data members they are remoted to. The control will be covered by a red X to indicate that the remote connection is not functioning.



**Note** You should use **Remote** to connect a control in a client process to a data member in a server process. Connections inside a single process can be made using **Object»Edit Connections**.

Because complex expressions are read-only values, you cannot remote directly to them. For the same reason, you cannot remote one control to another control's (intrinsic) data member (though you can remote a control to another control's value data member).

When you select the **Remote** option, you can choose whether or not the Pushbutton latches its output. The **Latch output** check box configures Lookout for controlling a latching-relay.

When a user clicks on a Pushbutton that has latching selected, the pushbutton remains depressed, sending an ON signal (TRUE or high) until the Remote Position signal turns ON. Assume for example that an operator clicks on `MotorStartPb`, configured above. The pushbutton remains pushed in, sending a TRUE signal, until `PLC.C101` goes TRUE. As soon as `PLC.C101` goes TRUE, the pushbutton releases.

Much like Remote Pushbuttons, **DDE** (Dynamic Data Exchange) Pushbuttons get their values from a remote source. This could be a cell in a spreadsheet, another DDE aware application, or a second copy of Lookout running on the network. See Chapter 5, *Dynamic Data Exchange*, in the *Lookout Developer's Manual* for information on **Service**, **Topic**, and **Item** parameters.

**Control security level** specifies the minimum security level operators must have to gain access to this individual object, and thus control it. See Chapter 6, *Security*, in the *Lookout Developer's Manual* for more information on security.

The **Log events** option creates a permanent audit trail for the object—who did what and when. Any depression of the Pushbutton is recorded to disk, including the time the button was depressed, and the operator’s account name. See Chapter 7, *Logging Data and Events*, in the *Lookout Developer’s Manual* for more information on logging events.

## Pushbutton Data Members

**Table 2-55.** Pushbutton Data Members

Data Members	Type	Read	Write	Description
(implicit)	logical	yes	no	Value of object (TRUE when button is depressed)
enable	logical	no	yes	If TRUE (the default), enables DDE. If FALSE, disables DDE. The default value is on. This input is ignored for non-DDE TextEntry objects.
graphic1-graphicN	numeric	yes	no	Denotes which display of this object will appear on an HTML report. Only one display is available for the ActiveX object.
reset	logical	no	yes	While this value equals TRUE, the control will be set to the value in <code>resetvalue</code> .
resetvalue	numeric	no	yes	Sets the value a control will take when the reset data member transitions from FALSE to TRUE.
snapdelay	numeric	yes	yes	Sets how long Lookout holds a control in a new position before snapping back to agree with an unchanged source.
value	numeric	yes	yes	The current value of the control. If you have remoted this control, then <code>value</code> is the current value of the position source.
visible	logical	no	yes	When FALSE, the Pushbutton cannot be seen on the display panel. When TRUE, the button can be seen and controlled.

You may at times make a remote source connection of a Lookout Pushbutton or Switch to a PLC or some other object that refuses to change value when you operate your control. In this situation you can use the new `snapDelay` data member.

Use the `SnapDelay` data member to set how long Lookout will hold the Pushbutton or Switch in a new position before snapping back to agree with the value in the unchanged remote source. Setting the `SnapDelay` to 0 disables the `SnapDelay` data member, so your remoted switch will not snap back.

The `SnapDelay` will also operate if the lag in reporting a change from your remoted object exceeds the `SnapDelay` time.

If the value to which your Pushbutton or Switch is remoted changes before the `SnapDelay` time has passed, the control operation is confirmed and the snap does not occur. If you set the `SnapDelay` data member to 0, your control responds to any further change in the remote source value.

As with all Lookout measures of time, the `SnapDelay` data member operates in terms of fractions of a day. You should make sure to scale inputs to this data member appropriately.

If you do not set the `SnapDelay` data member, Lookout defaults to 10 seconds.

When you operate a Pushbutton or Switch that has been set to a remote source, the (implicit) and value data members do not change until and unless they receive a new value from the remote source.

Any time the state of a Pushbutton or Switch changes, an event is logged that includes the source of the change in the event description.

## RadioButton

The `RadioButton` object creates a set of radio buttons on your panel. You can have from 2 to 40 buttons in a set. Only one button at a time can be activated in each radio button group.

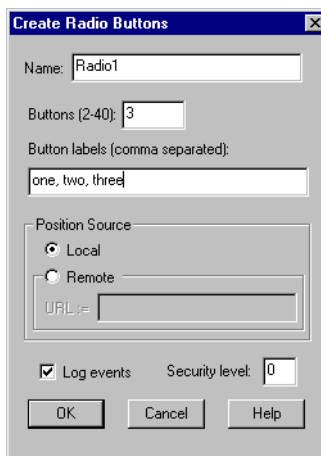

**Figure 2-68.** RadioButton Definition Parameters Dialog Box

Set the **Buttons (2-40)** in each set. You can have as many as 40 buttons in each group, but you must have at least 2.

**Position source** determines where the value of the `RadioButton` resides. **Local** indicates the value of the `RadioButton` lies within the object itself—on the control panel.

The **Remote** option tells Lookout to initialize the `RadioButton` value from a remote source. Adjusting the `RadioButton` changes the value in the register, and changing the value in the register adjusts the `RadioButton`. In effect, the `RadioButton` is tracking a remote value. This is especially useful when you want to prevent Lookout from changing the value of setpoints or registers upon initial startup, or reconnection of lost communication.

The **Remote** option calls for a URL to locate the data member you want to connect to. The URL field is green, and you cannot use a complex expression as a URL. If you need to use one `RadioButton` for several purposes, you can use a Symbolic Link to make a more complex connection than that possible with a URL.



You can right-click in the **URL** field and use the **URL Editor** dialog box to assemble the URL, in the same way you use the Lookout expression editor.

A remote position source connection is completely reciprocal. A change in your Lookout control changes the data member that control is remoted to. Any change in that data member also changes the control. It is not necessary, and is incorrect, to use the **Edit Connections** dialog box to connect a control object to its controlled data member.

Because the remote connection is reciprocal, you can only make such a connection to a data member that is either writable, or readable and writable.

When a process with remoted controls first opens, those controls take their initial values by following the URL to read the data members they are remoted to. The control will be covered by a red X to indicate that the remote connection is not functioning.



**Note** You should use **Remote** to connect a control in a client process to a data member in a server process. Connections inside a single process can be made using **Object»Edit Connections**.

Because complex expressions are read-only values, you cannot remote directly to them. For the same reason, you cannot remote one control to another control's (intrinsic) data member (though you can remote a control to another control's value data member).



**Note** You cannot break a group of radio buttons into multiple rows.

Enter any text for the buttons in the **Button labels** field. Separate each button label with a comma. If you need to include a comma or a backslash in any button text, precede that character with a backslash(\). If you want to leave a button blank, you can enter two commas without any text or numbers between the commas. You do not have to enter a label for every button. Lookout will leave each button after your last label entry blank. If you enter more labels than you have set buttons, your labels will be preserved but not displayed.

To log changes in button state, check the **Log Events** check box.

**Security level** sets the minimum security level an operator must have to change the radio buttons.

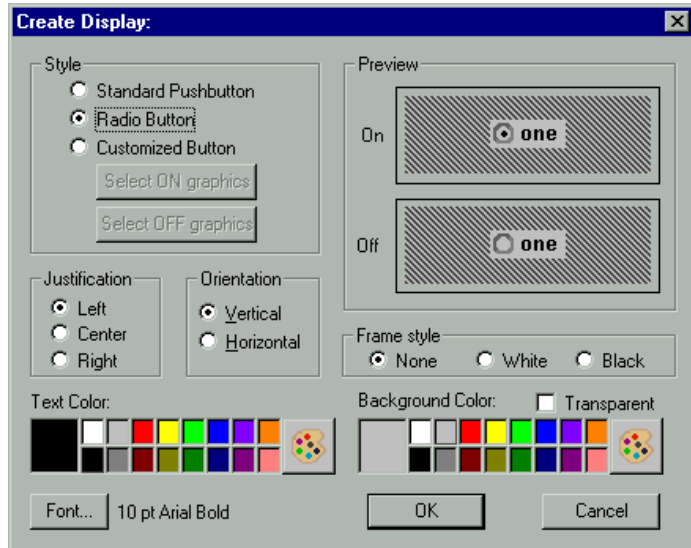

Figure 2-69. RadioButton Display Parameters Dialog Box

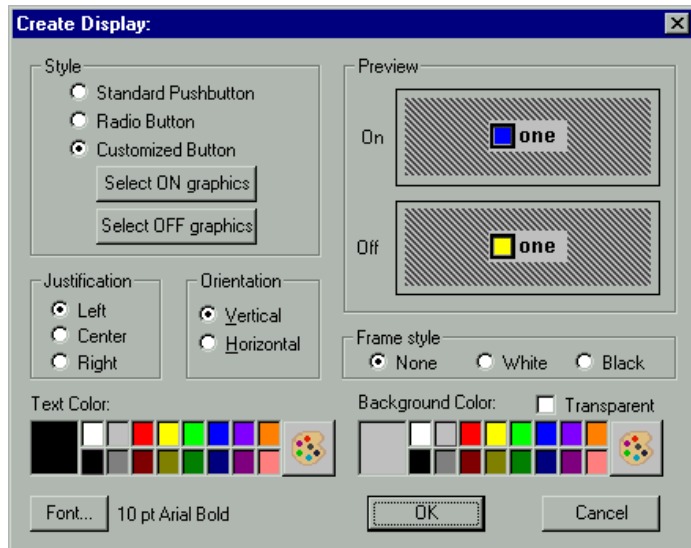

Figure 2-70. RadioButton Display Parameters Dialog Box with Custom Graphics Chosen

You can use a standard Lookout pushbutton, standardized radio buttons, or custom graphics for your radio button groups.

Notice that you cannot enter text in the **Create Display** dialog box. You must enter any text you intend to use in the **RadioButton Definition Parameters** dialog box. You can change font and text size in the **Create Display** dialog box. The first text label you entered for your radio button is displayed in the **Preview** field so you see the effect of font changes.

The default display uses a standard **Radio Button** display. You can adjust text and background color for any of your display choices.

Selecting **Standard Pushbutton** displays standard on/off buttons in your radio button array.

Select **Customized Button** for a free range of choices from the Lookout graphics library, or create your own ON/OFF indicators for a radio button array. See the *Creating Custom Graphics* section of Chapter 2, *Graphics*, in the *Lookout Developer's Manual* for detailed information on creating your own graphics for use on a Lookout control panel.

Set the **Orientation** of the radio button array to horizontal or vertical by checking the appropriate check box. Set label text **Justification** and button **Frame style** in the appropriate fields.

## RadioButton Data Members

**Table 2-56.** RadioButton Data Members

Data Member	Type	Read	Write	Description
1-40	logical	yes	no	Reports ON/OFF status of each button in a radio button set.
current	numeric	yes	no	Reports which radio button is active in a set.
graphic1- graphicN	numeric	yes	no	Denotes which display of this object will appear on an HTML report. Only one display is available for the ActiveX object.
(implicit)	numeric	yes	yes	Radiobutton value.
value	numeric	yes	yes	Number of the currently active radiobutton.
visible	logical	yes	yes	Controls visibility of a radio button set. Default=TRUE.

**Related Objects** *L3Pot, L3Pushbutton, L3Switch, Pot, Pushbutton, Switch*

# Recipe

Recipe objects are an efficient means of importing large arrays of data (namely recipes and their ingredients) into Lookout using an Excel (.xls) spreadsheet. Once created and implemented, the operator can easily and quickly change the current recipe with the click of the mouse, thus selecting a new set of ingredients.

The best way to describe how the Recipe class works is to step through a typical example, in this case involving cookie manufacture.

There are two steps to creating and implementing a recipe object. First, you define your recipes with their respective ingredients in a spreadsheet program such as Excel (anything that creates an .xls file will work—including Lotus 123). You can define up to 1,000 recipes in a single .xls file. Each recipe can have up to 255 ingredients. Three cookie recipes are defined in this spreadsheet.



**Note** The spreadsheet must be saved in Excel 4.0 format.

	A	B	C	D	E	F	G	H	I	J	K	L	M	N	O
1		Flour	Eggs	Butter	White Sugar	Brown Sugar	Powdered Sugar	Vanilla	Salt	Baking Soda	Cinnamon	Oats	Ginger	Chocolate	Shortening
2	Chocolate Chip	100	50	60	10	8	5	6	3	8	7	0	0	60	43
3	Oatmeal	120	45	50	15	14	3	5	4	7	5	50	0	0	51
4	Ginger Snap	110	40	40	8	11	4	4	5	9	8	0	57	0	68
5															

The first row of the spreadsheet is reserved for ingredient names. They begin in column B. These ingredient names later become alias data

members of the Recipe object. Therefore, ingredient names must be unique. They cannot have the same name as a native data member (see the Recipe Data Member table for data member names). Also, you cannot name an ingredient `missing`; this is a reserved word. Valid characters in an ingredient name include A – Z, 0 – 9, the dollar sign (\$), and a period (.). If you enter `Hi_@#!!There` as an ingredient name, Lookout names the alias `HiThere`. Alias names are case sensitive.

Beginning in Row 2, Column A lists the names of the various recipes. Recipes follow the same naming convention as ingredients. Each recipe is followed by its unique ingredient values.

Ingredient values can represent process inputs, parameters, and outputs. Process inputs typically represent raw materials and other inputs consumed in the batch process. Examples include the number of eggs consumed, amount of flour used, amount of energy consumed, possibly even work hours required or amount of traceable fixed costs consumed.

Another type of ingredient value is a process parameter. Process parameters identify operational settings such as furnace cooling time, an air pressure setpoint, or a Low pH alarm limit. Process parameters might also include identifications of specific equipment to be used during the batch process.

The third type of ingredient value is a process output. Such an ingredient value might represent the number of finished cookies expected from the batch, amount of byproduct expected, or a cost variance calculation based on the selected recipe.

Ingredient value quantities may be specified as constants or as equations based on other formula parameters such as batch size.

The second part of defining a recipe involves defining a recipe object in Lookout.

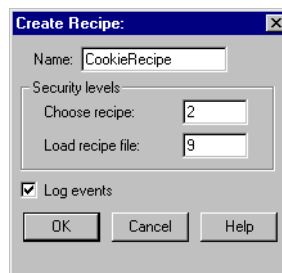

**Figure 2-71.** Recipe Definition Parameters Dialog Box

The first recipe dialog box defines security and event data logging.

**Choose recipe** security level specifies the minimum security level an operator must have to be able to select a recipe from all the recipes listed in the currently selected spreadsheet file.

**Load recipe file** security level specifies the minimum security level an operator must have to be able to select a different spreadsheet file.

The **Log events** option creates a permanent audit trail for the object—who did what and when. Any selection of a different recipe or recipe file is logged to disk, including the time the action occurred and the operator's account name. See Chapter 7, *Logging Data and Events*, in the *Lookout Developer's Manual* for more information on logging events.

After defining security and event data logging, Lookout presents you with a file selection dialog box. Remember that Lookout only accesses Excel 4.0 and compatible files.

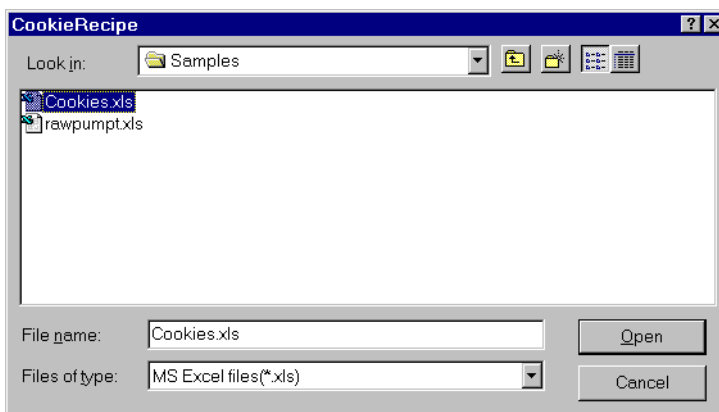

Select the `cookies.xls` spreadsheet file because it has the three batch recipes in it.

Once a file is selected, Lookout presents a list of recipes.

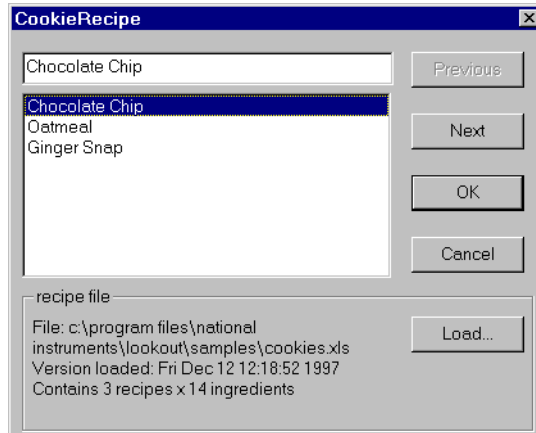

As you can see, the recipe names come from column A of the spreadsheet. You can use the **Previous** and **Next** buttons to identify a recipe from among the list, or type the name in the data entry field above the list. (This same dialog box appears later when an operator clicks on the pushbutton representing this object.) Click on **OK** to choose the recipe you want to use. Select the recipe for oatmeal cookies.

The recipe file **Load** button invokes the file list dialog box, described previously. Click on this button to select a new `.xls` file.



**Note** If the recipe is changed in the spreadsheet, the change is noted in the recipe file dialog box—but the values currently resident in the object data members remain intact. The operator must load the spreadsheet again to update the copy of the recipe file in Lookout. If you select a new `.xls` file to load but click on the Cancel button, it does *not* update! You must select **OK** for the recipe to actually be loaded.

To display the recipe, drag the Recipe object, not the (implicit) data member, from the Object Explorer to the panel you want the display to appear on. The **Display recipe** dialog box appears, as shown in the following figure.

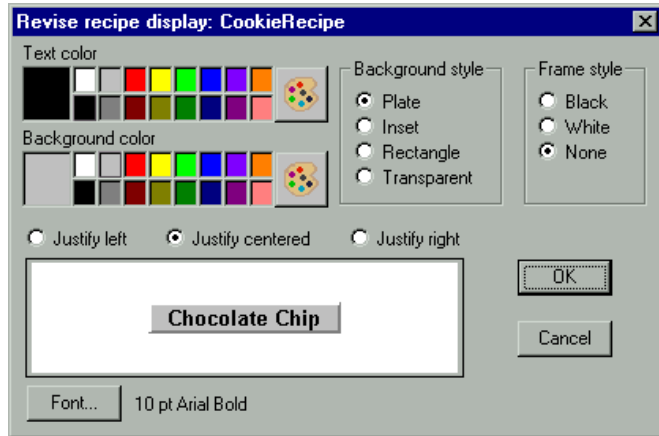

**Figure 2-72.** Recipe Object Display Parameters Box

After you choose the object display parameters, you can paste it into the panel.

When you select a new recipe, Lookout writes the ingredient values for the selected recipe into the corresponding data members of the object.



The actual number of data members that a recipe object has is based on the number of ingredients within it. This is best demonstrated by looking at the Insert Expression dialog box.

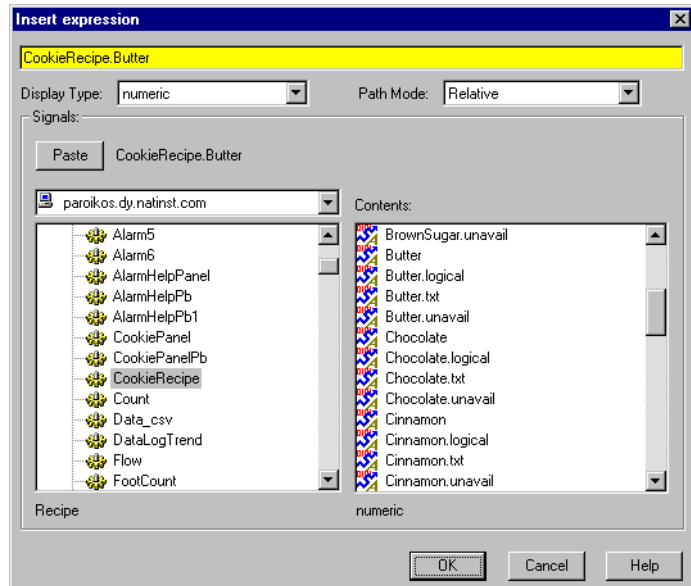

Notice that there are four data members for each defined ingredient. Actual data member names vary from object to object, depending upon your recipe ingredients. However, the four readable data member types for each ingredient are consistent.

## Recipe Data Members

**Table 2-57.** Recipe Data Members

Data Member	Type	Read	Write	Description
(implicit)	text	yes	no	Name of currently selected recipe
B – IV	numeric	yes	no	Each letter, B through IV, represents a column in the spreadsheet. The value of the data member is the numeric amount of the ingredient for the currently selected recipe.

**Table 2-57.** Recipe Data Members (Continued)

<b>Data Member</b>	<b>Type</b>	<b>Read</b>	<b>Write</b>	<b>Description</b>
B.logical through IV.logical	logical	yes	no	Each letter, B through IV represents a column in the spreadsheet. Returns TRUE (ON) if the amount of the ingredient in the spreadsheet cell for the selected recipe is greater than zero. Returns FALSE if the specified amount for the ingredient is zero.
B.txt – IV.txt	text	yes	no	Each letter, B through IV represents a column in the spreadsheet. The value of the data member is the textual amount of the ingredient for the currently selected recipe.
B.unavail through IV.unavail	logical	yes	no	Each letter, B through IV represents a column in the spreadsheet. Returns TRUE if the spreadsheet cell is empty. Returns FALSE if the cell contains data.
pick1 through pick1000	logical	no	yes	Upon transition from FALSE to TRUE, chooses the respective recipe within the spreadsheet. When used with pushbutton objects, these data members can eliminate the need for operators to use the recipe list dialog box.

**Comments** The recipe object reads a block of continuous columns. Therefore, the ingredient names should be a contiguous list in Row 1. If a recipe does not use a particular ingredient, just leave the respective cell blank.

When Lookout encounters a blank cell in Column A, it ignores the entire row. Thus, you can easily annotate your recipes by leaving a cell in Column A blank and adding text to the cell in Column B of the same row.

# Report

Use the new Report object to generate an HTML page that you can put up on a Web server to allow people to access the reported information.

Unlike the Lookout Web Client, the data on a report page is not live; the report page features a snapshot of the data as it existed when the page was generated. The advantage of this is that no downloading is necessary for someone to browse the HTML page this object creates, and no Lookout objects can be manipulated or changed by those browsing the page.

You can set your report object up so that it generates updated pages at regular intervals and under special circumstances.

Create an HTML report using the **Create Report** dialog box, as shown in the following figure.

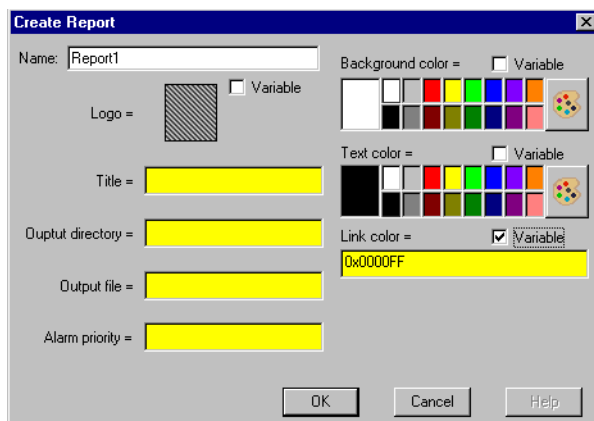

The **Create Report** dialog box does not have parameters in the same way as most Lookout Create object dialog boxes. Except for the name of the Report object, all of the entries in the **Create Report** dialog box are actually data members. You can create a Report object in Lookout by filling only the **Name** field, and using data members to accomplish remaining tasks.

You also have the choice of making some of the elements on the **Create Report** dialog box variables instead of constants. For example, because the elements are variables, you can use a text entry to select a **Logo** to appear at the top left of your report page and select a specific graphic.

If you use a Logo, enter a title to appear next to the Logo in the **Title** field. Set the directory for the web page to be built in using the **Output directory** field, and define the file name in the **Output file** field.

You can select the colors for the report page background, for the text, and for links from the color selection boxes, or you can enter hexadecimal values in the form of 0x000000. This is an Red Green Blue (RGB) setting where the first two digits of the hexadecimal number set the level of red, the second two digits set the level of green, and the third pair of digits set the blue levels. The color blue, for instance, would be 0x0000FF, and red 0xFF0000. White is 0xFFFFFFFF and black is 0x000000. You can use a Pot or some other numeric input to alter the colors.

Use the Report object data members to determine what objects will be placed on your report page, and what order those elements will appear in.

The elements you can use on report pages are:

- Background image
- Lookout display elements, such as a Pot slider, a HyperTrend chart, or even a Lookout panel with all its contents
- Graphics from the Lookout graphics collection
- Text or messages you create in Lookout while your processes are running
- Inclusions, from preexisting text files, including HTML coded text
- Links to other HTML pages
- Ordered lists
- HTML tables
- Unordered lists
- Data direct from Lookout data members

## Placing Elements on the Report Page

If you use a Logo, it will always be at the upper left corner of the report page, with the title immediately to the right.

The rest of the elements set to appear on the page appear in order of their extension number, so that `Display1` will appear before `Display5`. When different elements have the same extension number they appear in the following order:

1. Raw HTML
2. HTML links

3. Values
4. Ordered Lists
5. Unordered lists
6. Tables
7. Includes
8. Graphics

The results will be more predictable if you use a unique extension number for each element on the report page.

You place Lookout displays, such as indicators, HyperTrends, or Pots by connecting the Report Display connector to the Graphic data member now available in all Lookout objects that have a displayable component. Also notice that when you place a display component on the Lookout panel, the name of the object and its display number, such as `HyperTrend2.display1`, appears in the status bar at the bottom of the Lookout workspace. Other displays from that same HyperTrend object will be noted as `HyperTrend2.display2`, and so on. Use this feature to make sure the correct display is connected. A connection to make the second display taken from HyperTrend2 appear as the first element on your report page would take the form `Report1.Display1 = HyperTrend2.graphic2`.

## Generating the Report Page

To generate a report page, connect a pushbutton or some other logical input to the Generate data member. Each time the input goes high (changes to TRUE) Lookout will generate the report page using the current data.

## Making A Report Page Available

As with the Lookout Web Client, you must have the HTML report page present on a computer running web server software for people to access your report from across a local network from the Internet. Consult your web server documentation for specific information about setting up a web server.

## Report Data Members

**Table 2-58.** Report Data Members

<b>Data Member</b>	<b>Type</b>	<b>Read</b>	<b>Write</b>	<b>Description</b>
AlarmPriority	numeric	yes	yes	Sets the priority of an alarm generated by this object.
BG color	numeric	yes	yes	Background color of your report page. Set through the create object dialog box, or use an RGB hexadecimal variable.
BGImage	text	yes	yes	Background image for your report page. Use a well formed Lookout path, relative to the <code>graphics</code> directory, to the <code>.BMP</code> or <code>.WMF</code> file you want to use as the background image for your report page.
Display1 - Display100	numeric	no	yes	Places a display on your report page, in the order of the numeric component of the data member. Activate this feature by connecting the <code>DisplayN</code> data member to the <code>Graphic</code> data member of any Lookout object that has a displayable component, such as a switch, a HyperTrend, and so on.
Generate	logical	yes	yes	Connect a logical input to this data member. When the connection changes to <code>TRUE</code> (goes high), Lookout will generate a web report page using the current data.

**Table 2-58.** Report Data Members (Continued)

<b>Data Member</b>	<b>Type</b>	<b>Read</b>	<b>Write</b>	<b>Description</b>
Graphic1 - Graphic100	text	yes	yes	Places a graphic on your report page in the order of the number component of the data member. Use a well formed Lookout path, relative to the <code>graphics</code> directory, to the <code>.BMP</code> or <code>.WMF</code> file you want to use.
HTML1- HTML100	text	yes	yes	This is a text connection to Lookout text sources. You can enter plain text or HTML encoded text. If the text file is HTML encoded, it will display properly on your report page.
Include1 - Include100	text	yes	yes	This data member will include a text file as text on your report page. Use a well formed Lookout path (full path) to the text file you want to add to your page. If the text file is HTML encoded, it will display properly on your report page.
LinkColor	numeric	yes	yes	Sets the color for links to other URLs. Set through the create object dialog box, or use an RGB hexadecimal variable.
LinkText1 - LinkText100	text	yes	yes	Connect to a Lookout text source to put a URL link on your web page. A <code>LinkText</code> data member must be paired with a <code>LinkURL</code> data member to work. That is, the <code>LinkText</code> data member must have the same number as the <code>LinkURL</code> data member carrying the URL the text activates.

**Table 2-58.** Report Data Members (Continued)

<b>Data Member</b>	<b>Type</b>	<b>Read</b>	<b>Write</b>	<b>Description</b>
LinkURL1 - LinkURL100	text	yes	yes	Connect to a Lookout text source to put a URL link on your web page. A LinkURL data member must be paired with a LinkText input. That is, the LinkText data member must have the same number as the LinkURL data member carrying the URL the text activates.
Logo	text	yes	yes	A special graphic placement category you can set from the create object dialog box or through the data member. The Logo graphic is always placed at the top left of your report page. It can be left empty if you choose. Use a well formed Lookout path, relative to the graphic directory, to the .BMP or .WMF file you want to use.
OList1.1 - OList100.99	polymorphic	yes	yes	Ordered list element (an ordered list is a list in which each element is assigned a number). You can have as many as 100 lists with as many as 99 items in each. This data member can accept any Lookout data type.
OListNF1 - OListNF100.99	text	yes	yes	Numeric formatting for the ordered list. Connect this data member to a Numeric Format object, which you then use to set the numeric format for the corresponding item in an ordered list.
OutDir	text	yes	yes	The directory the report object will build your HTML page in. This should be a pre-existing directory.



**Table 2-58.** Report Data Members (Continued)

<b>Data Member</b>	<b>Type</b>	<b>Read</b>	<b>Write</b>	<b>Description</b>
OutFile	text	yes	yes	Name of the file you want to save your report page in.
Table1.A1 - Table100.Z99	polymorphic	yes	yes	HTML table. You can have up to 100 tables. Each cell of your table has a unique extension, beginning with A1 for the upper left cell.
TableNF1.A1 - TableNF100.Z99	numeric	yes	yes	Numeric formatting for the HTML table. Connect this data member to a Numeric Format object, which you then use to set the numeric format for the corresponding table cell.
TextColor	numeric	yes	yes	The default color for text on your HTML report page. Set through the create object dialog box, or use an RGB hexadecimal variable.
Title	text	yes	yes	Title is a special text string for your report page. The title is always placed to the left of the Logo, if room permits and if there is a Logo.
UList1.1 - UList100.99	polymorphic	yes	yes	Unordered list element (an unordered list is a list in which each element is preceded by a bullet or some other symbol). You can have as many as 100 lists with as many as 99 items in each. This data member can accept any Lookout data type.

**Table 2-58.** Report Data Members (Continued)

<b>Data Member</b>	<b>Type</b>	<b>Read</b>	<b>Write</b>	<b>Description</b>
UListNF1.1 - UListNF100.99	text	yes	yes	Numeric formatting for the unordered list. Connect this data member to a Numeric Format object, which you then use to set the numeric format for the corresponding item in an unordered list.
Value1 - Value100	polymorphic	yes	yes	Inserts the Lookout value connected to it onto your report page.
ValueNF1 - ValueNF100	numeric	yes	yes	Numeric formatting for a Lookout value. Connect this data member to a Numeric Format object, which you then use to set the numeric format for the corresponding value.

# Run

You can use Run objects to start an external program file from within Lookout. When the result of the **Run when** logical expression goes TRUE, the object executes the **Command line**.

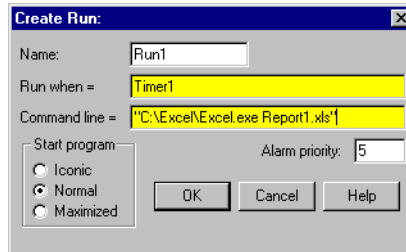

**Figure 2-73.** Run Definition Parameters Dialog Box

In this example, Lookout runs an Excel macro called REPORT1.XLM when the logical value returned by Timer1 goes TRUE. Timer1 is a TimeofDay object that triggers the report to run every day at 8:00 a.m.

The **Command line** text expression must be enclosed in quotation marks as shown. Notice that the example includes the full path name of the executable file. Ensure that your command line meets DOS syntax requirements. Because this is an expression data field, the command could be the result of a text expression.

Passing arguments in the Run Object in Lookout requires proper use of double quotes depending on how many arguments you are passing and whether or not those arguments have spaces in the path.

If your argument has no spaces in the path, you need only insert double quotes before and after the argument.

If your argument has spaces in the path, you must insert two double quotes at the beginning and the end of that argument to define it as a single argument. These two double quotes are in addition to the double quotes you must use in passing any argument.

For example, when passing a single argument the following examples demonstrate the correct use of double quotes (spaces are exaggerated for effect):

```
""c:\my excel\autoexec.xls""
"c:\excel\excel.exe"
```

When passing two or more arguments, you follow the same rules for each argument, as illustrated in the following examples:

```
""c:\program files\msoffice\excel\excel.exe" c:\autoexec.xls"
""c:\program files\excel\excel.exe" ""c:\my excel\autoexec.xls""
"c:\excel\excel.exe c:\working\autoexec.xls"
```

You can specify how an application presents itself when you activate it with the **Start program** selections. If you select **Normal**, the application window appears in front of the open Lookout window when it is activated. If you want to reduce the application to an icon each time you start it, select **Iconic**. If you select **Maximized**, the application window replaces the Lookout window on the screen. (Lookout is still running; you just cannot see it. Press <Alt+Tab> to switch between applications.)

**Table 2-59.** Run Data Members

<b>Data Member</b>	<b>Type</b>	<b>Read</b>	<b>Write</b>	<b>Description</b>
none	—	—	—	Run does not have any data members

**Comments** If the application does not automatically shut down, multiple instances of the program may be running because of previous starts. Over time, this can snowball to the point where Windows performance is severely hampered.

If you want to execute DOS commands from within Lookout, put the commands in a DOS batch file (.bat) and then identify the batch file in the Command Line.

# Sample

The **Sample** object samples and holds data. Any time the **Sample** expression transitions from OFF to ON and the **Enable** expression is TRUE, the **Sample** object samples and stores a **Data** expression. **Sample** maintains an array of up to 35 previous samples. If **Enable** is left blank it is assumed to be TRUE. **Data** is a numeric expression while **Sample** and **Enable** are logical.

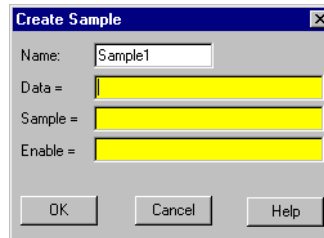

**Figure 2-74.** Sample Configuration Parameters Dialog Box



**Note** **Sample** does not have a display parameters dialog box. You can display the result of a **Sample** output signal by using its data member in an expression.

## Sample Data Members

**Table 2-60.** Sample Data Members

Data Member	Type	Read	Write	Description
(implicit)	numeric	yes	no	Current <b>Data</b> value—tracks <b>Data</b> input value.
1 – 35	numeric	yes	no	Previous samples. Signal 1 is the most recent sample since <b>Sample</b> went high. If you display <b>Sample</b> , you display the current and active value for the object—that is, the (implicit) value. If you display <b>Sample.1</b> , you display the least complete value.
DataReset	logical	no	yes	Upon transition from FALSE to TRUE, resets to zero all data members—including the current value and all previous samples.

**Comments** The **Reset** expression can be a regular pulse interval created by a TimeOfxxxx timer. For example, if you want to sample the temperature every hour of the day, use the output signal from a TimeOfHour timer in the **Reset** expression to sample the temperature at the beginning of each hour.

**Related Objects** *Average, Maximum, Minimum, SampleText*

# SampleText

SampleText samples and stores the result of the **Data** expression any time the **Sample** expression transitions from OFF to ON and the **Enable** expression is TRUE. SampleText maintains an array of up to 35 previous samples. If **Enable** is left blank it is assumed to be TRUE.

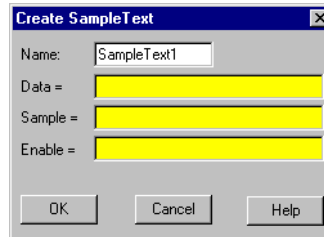

Figure 2-75. SampleText Definition Parameters Dialog Box

**Data** is a text expression while **Sample** and **Enable** are logical expressions.



**Note** SampleText does not have a display parameters dialog box. You can display the result of a Sample object output signal by using its data member in an expression.

## SampleText Data Members

Table 2-61. SampleText Data Members

Data Member	Type	Read	Write	Description
(implicit)	text	yes	no	Current <b>Data</b> value. Tracks <b>Data</b> input value.
1 – 35	text	yes	no	Previous samples. Signal 1 is the most recent sample since <b>Sample</b> went high.
DataReset	logical	no	yes	Upon transition from FALSE to TRUE, resets all data members—including the current value and all previous samples.

**Related Objects** [Sample](#), [L3TextEntry](#), [TextEntry](#)

# Scale

You can use the Scale object to create dynamic scales—that is, scales whose ranges and divisions can change based on numeric parameter expressions.



**Note** If you want to create a simple scale that does not change dynamically (which is normally the case), use the **Insert»Scale** command.

**Figure 2-76.** Scale Definition Parameters Dialog Box

**Absolute Minimum** and **Absolute Maximum** are numeric constants. They define the fullest possible range that the scale can show. These values act as clamps, restricting **Minimum** and **Maximum**.

**Minimum** and **Maximum** are numeric expressions you can use to change the minimum and maximum values on the scale. In the preceding example, the highest value of the scale (**Maximum**) is 400 if `Pot1` is less than 400, 1600 if `Pot1` is greater than 1600 (because of the **Absolute Maximum**), or equal to the value of `Pot1`.

**Major unit** specifies the number of units between major tick marks. **Minor unit** specifies the number of units between minor tick marks.



When you place a Scale on a panel, the **Display Scale** dialog box appears.

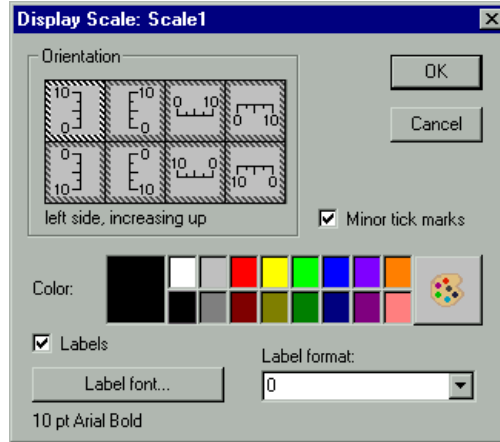

**Figure 2-77.** Scale Display Parameters Dialog Box

Specify **Orientation**, **Color**, **Label format**, and **Label font** as you choose.

You can remove minor tick marks by deselecting the **Minor tick marks** check box and you can remove label numbers from your scale altogether by deselecting the **Labels** check box. (Only major units have numeric labels.)

## Scale Data Members

**Table 2-62.** Scale Data Members

Data Member	Type	Read	Write	Description
graphic1-graphicN	numeric	yes	no	Denotes which display of this object will appear on an HTML report. Only one display is available for the ActiveX object.
visible	logical	no	yes	When TRUE, the Scale becomes visible on the control panel. When FALSE, it is invisible. The default value is TRUE.

**Comments** Many people use this object class in conjunction with HyperTrends that are configured for a variable Y axis. They configure the **Minimum** and **Maximum** parameters of the Scale object to follow the same values as the **Max** and **Min** data members of the HyperTrend Object.

# Sequencer

The Sequencer object is a method for cycling through a collection of up to 100 differently configured ON/OFF states for your process.

Each Sequencer state has 26 logical outputs. Outputs left blank are considered OFF.

You set each output to ON or OFF for each state. You can also create jumps to skip from one state to another, or activate immediate jumps to a designated state.

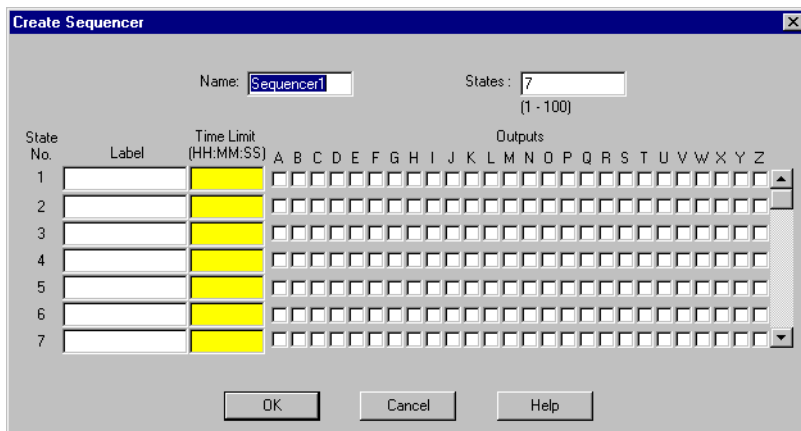

Figure 2-78. Sequencer Definition Parameters Dialog Box

The **States** field activates the states you want in your sequence loop. If you set **States** to 5, the sequence object will pass through states 1 through 5 and then return to state 1 to repeat the cycle.

Notice that unused states can still be configured. In this way you can preconfigure special states, create subroutines, and so on. See the [Programming the Sequencer](#) section for further information on using this object.

Use **Label** to label each state.

The **Time Limit** parameter determines how long the Sequencer holds each state. If you leave this parameter blank, the Sequencer halts on that state until a **Goto** or **Jump** is activated, or the **Time Limit** parameter is changed.



**Note** When you set the Time Limit expression to reference a Lookout control, you must make sure the output of that control is either in HH:MM:SS format, or in days.

**Outputs** are the ON/OFF settings for each state.

## Programming the Sequencer

Left unmodified, the Sequencer cycles through the states selected in the **States** field of the **Sequencer parameter configuration** dialog box, beginning with state 1. If you enter 4 in the **States** field, the Sequencer will cycle through states 1—4 continuously, spending the amount of time in each state set by the **Time limit**.

Use the `Goto` data members to jump to a given state of the Sequencer immediately. Use the `Jump` data member to skip automatically from one state to a target state.

There is a tiny lag in state transition when you use the `Jump` data member. For instance, if you have a sequence cycling through states 1—8, and under some circumstances you want to skip states 5 and 6, moving directly from state 4 to state 7, set the `jump5.7` data member to `TRUE`. When the Sequencer reaches the end of the state 4 **Time limit**, it switches to state 5, and then immediately jumps to state 7. State 5 will be active for a brief period (about 10 ms), however, which you should take into account in designing your sequences.

You can use sequential jumps if you choose. When you activate a jump from state 1 to state 5, for example, and also a jump from state 5 to state 9, the Sequencer skips from state 1 to state 9 with a 10 ms delay at state 5.

If you use a `Jump` or `Goto` data member to activate a state outside the number you selected in your **States** field, the Sequencer will continue to cycle through any states following the target state, until it either reaches a state with no set **Time limit**, or state 100.

If the Sequencer reaches a state with no set **Time limit**, it remains in that state until a `Goto` or `Jump` is activated, or until the **Time Limit** parameter is changed.

If the Sequencer reaches state 100, and if state 100 has a **Time Limit** set, the Sequencer cycles to state 1 at the end of that time, resuming its cycle inside the states defined by the **States** parameter.

If you use a `Goto` or `Jump` data member to activate a state outside the ordinary cycle of a Sequencer object, you must use the `Jump` or `Goto` data members to return the sequence to its automatic cycle.

## Sequencer Data Members

See the [Programming the Sequencer](#) section for detailed information on using Sequencer data members.

**Table 2-63.** Sequencer Data Members

Data Member	Type	Read	Write	Description
A – Z	logical	yes	no	Sequencer outputs
Goto1 – Goto100	logical	no	yes	When activated, forces Sequencer to go to the indicated state
Jump1.1 – Jump100.100	logical	no	yes	When activated, jumps from the state indicated by the first number to the state indicated by the second number
StateName	text	yes	no	Reports the currently active state name ( <b>Label</b> )
StateNumber	text	yes	no	Reports the sequence number ( <b>State No.</b> ) of the current state
Time	numeric	yes	no	Reports the current length of time the Sequencer has been in the current state
TimeLimit	numeric	yes	no	Reports the length of time set for the Sequencer to hold the current state

# Sort

The Sort object sorts up to 1000 numbers (numeric values) in ascending or descending order. It also gives the rank of these sorted numbers relative to their original position in the unsorted list.

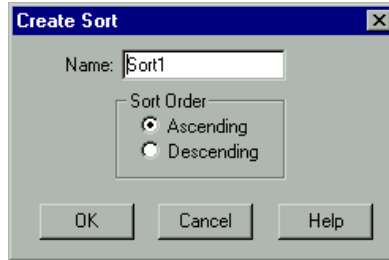

**Sort Order** options define how the numbers are to be sorted: ascending order or descending order. This list sorts when you activate the `SortNow` data member.

The logical **SortNow** member sorts the list when the signal connected to it goes TRUE. The following table shows an unsorted list, the same list after sorting it in descending order, and the ranks of each sorted value.

Unsorted	Sorted (Descending)	Rank
3	9	2
9	5	3
5	4	4
4	3	1

To create this table as a display on a Lookout panel, drag the `va1` data members (`va10–va13`) to the panel as a display for the Unsorted column, the `sorted` data members (`sorted0–sorted3`) for the Sorted column, and the `rank` data members (`rank0–rank3`) for the Rank column.



**Note** Do not leave any intermediate values unconnected. For instance, the previous unsorted numbers need to be connected consecutively to data members `va10` through `va13` with no omissions. The presence of duplicate numbers does not affect sorting or the ranks. In such situations, the duplicate numbers get sorted and ranked depending on their original positions.

## Sort Data Members

**Table 2-64.** Sort Data Members

<b>Data Member</b>	<b>Type</b>	<b>Read</b>	<b>Write</b>	<b>Description</b>
rank0 – rank999	numeric	yes	no	Rank of the sorted numbers with respect to their original positions in the unsorted list
sorted0 – sorted999	numeric	yes	no	Sorted values in ascending or descending order
SortNow	logical	no	yes	When TRUE, sorts the list
val0 – val999	numeric	yes	yes	Original unsorted values

# Spinner

Spinner is a small, rotating disk. Its rotation speed can be variable, to represent the magnitude of a numeric **Signal**, or its rotation can be turned on or off based on the logical signal, **Spin**.

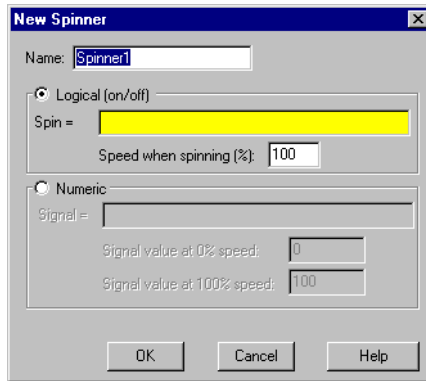

**Figure 2-79.** Spinner Definition Parameters Dialog Box

**Logical (on/off)** and **Numeric** choose whether the spinner responds to a logical signal or a numeric signal. Choose **Logical** if you want to be able to turn the spinner on and off. Choose **Numeric** if you want the speed and direction of the spinner to change depending on a numeric variable.

**Spin** is a logical expression. When the result of the logical expression is TRUE, the spinner rotates at the rate defined by the **Speed when spinning (%)** field. **Speed when spinning (%)** is a numeric constant, ranging from -100 to 100.

Connecting the spinner to a positive value rotates the spinner in a counterclockwise direction. A negative value rotates the spinner in a clockwise direction.

**Signal** is a numeric expression. The result of this expression dictates the spin speed based on the linear range defined by **Signal value at 0% speed** and **Signal value at 100% speed**.

## Spinner Data Members

**Table 2-65.** Spinner Data Members

Data Members	Type	Read	Write	Description
graphic1-graphicN	numeric	yes	no	Denotes which display of this object will appear on an HTML report. Only one display is available for the ActiveX object.

**Comments** Spinners are typically used to represent flow through a line or to show a motor running.





# Spreadsheet

Spreadsheet permanently stores data to disk in spreadsheet files. You can log data on even and uneven intervals, when a data value changes, when an event occurs, or when any one of these things happen. Hence, you can implement complex logging criteria to meet almost any data storage need.

After each log, a new row is automatically added to the spreadsheet file. Lookout can log a new row of data approximately 10 times per second; however, the time stamps associated with each row are rounded to the nearest second.

Each spreadsheet file may store any number of data signals. Each data signal is assigned a spreadsheet column, beginning with column number two. The first column contains the date and time. The first row contains the expressions associated with the data in each column. You may create any number of Spreadsheet objects for a given process.

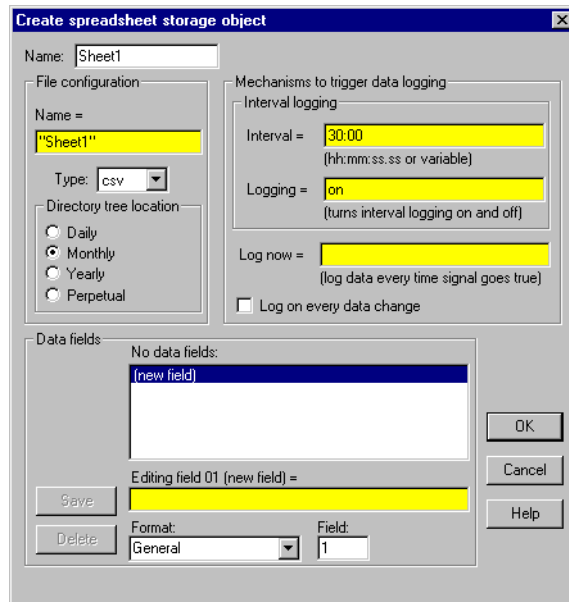

**Figure 2-80.** Spreadsheet Configuration Parameters Dialog Box

**Name** is the filename used to create a spreadsheet file. Lookout assigns a DOS filename to each spreadsheet file by adding the **Type** extension to the **Name**. Currently, Lookout supports only one **Type**: comma separated value format (.csv). Most database and spreadsheet programs including Microsoft Excel directly read the .csv file format.

Because the **Name** parameter is a text expression field, you can create new .csv files with unique names dynamically. This is especially useful for recording batch processing data. The definition dialog box Figure 2-76 is configured so that an operator can enter a batch name using a TextEntry object before the batch is started. The text expression appends the filename to the specified path, C:\BATLOG\. So if the operator enters a file name like BATCH71, then the full path name would be C:\BATLOG\BATCH71.CSV. When the BatchRun logical signal goes TRUE, Lookout creates the new .csv file and begins writing to it. When BatchRun goes FALSE, logging ends, leaving a comprehensive log of all data associated with the batch.

This example forces Lookout to store the .csv file in a particular directory because it specifies a full path name. If you enter a relative path name like "\BATLOG\" &TextEntry1, the file is located in that subdirectory of the identified **Directory tree location**. So, for example, the full path name of the file might be C:\LOOKOUT\1995\SEP\BATLOG\BATCH71.CSV.

If you enter just a filename such as "DATA", the file location is based on the Lookout directory. For example, the full path name of the file might be C:\LOOKOUT\1995\SEP\DATA.CSV.

If you select **Daily**, Lookout creates a new file and subdirectory every day in which to store the data. If you select **Monthly**, Lookout creates a new file and subdirectory every month in which to store the data. If you select **Yearly**, Lookout creates a new file and subdirectory every year. **Perpetual** files are stored in the root directory as specified by your **Data files location** parameter.

The following examples are the DOS filenames and directory trees created by Lookout for a spreadsheet file named, DATA.

Daily	Yearly
c:\lookout\1993\sep\09\data.csv \sep\10\data.csv \sep\11\data.csv	c:\lookout\1993\data.csv \1994\data.csv \1995\data.csv
Monthly	Perpetual
c:\lookout\1993\sep\data.csv \oct\data.csv \nov\data.csv	c:\lookout\data.csv

The **Mechanisms to trigger data logging** are a set of tools used to create a simple or complex logging scheme, as desired. Use these parameters to log data based on a timer, event, or any combination of the two. When the spreadsheet is triggered, all data in the Data fields is logged to disk.

**Interval** is a numeric expression used to create a Pulse timer with a pulse period of the specified time period and a pulse duration of zero. Normally this is a time formatted constant value such as 15:00 (fifteen minutes), for example.

**Logging** is a logical expression that turns the **Interval** parameter on and off. It could be a switch on a control panel, a logical input from an external device, or a more complex expression. Normally this is a constant value, ON or OFF.

**Log now** is a logical expression. When **Log now** transitions from OFF to ON, Lookout logs the data. A transition from ON to OFF has no effect. This expression could be a pushbutton on a control panel, a logical signal from a device, or a more complex expression.

The **Log on every data change** option should be used with care. When turned on, it triggers the logging of data any time any one of the data fields experiences a change. This is normally used to log the starting and stopping of pumps, opening and closing of valves, or other similar events. If your data fields contain even a single analog value that changes often, you could end up triggering the logger thousands of times. Or if they contain a logical value that changes frequently, you could have the same problem.

The **Data fields** window lists all expressions that have been entered for logging in the order of their field number.

The **Save** button saves your new or modified expression in the **Data fields** window along with a new field number if any. Normally, **Data fields** contain simple expressions like `PLC1.TankLevel`.

The **Delete** button deletes the currently selected expression from the data fields list.

The **Format** option specifies the numeric format assigned to the currently selected numeric expression when it is logged to disk. This has no effect on logical or text expressions.

**Field** indicates the number of the currently selected data field.



**Note** Field numbers should not be modified after data has been stored or the data will not appear under correct headers until a new file is created.

## Spreadsheet Data Members

**Table 2-66.** Spreadsheet Data Members

<b>Data Members</b>	<b>Type</b>	<b>Read</b>	<b>Write</b>	<b>Description</b>
logged	logical	yes	no	Spreadsheet file update pulse. The Spreadsheet object generates this logical pulse with a pulse duration of zero after each successful log.

# SqlExec

SqlExec is an object Lookout uses to communicate with the ODBC driver. ODBC allows Lookout to connect to any database that supports ODBC.

SqlExec connects to ODBC using the standard ODBC calls, and queries the database using SQL statements. The data, if any, is returned in the object data members.

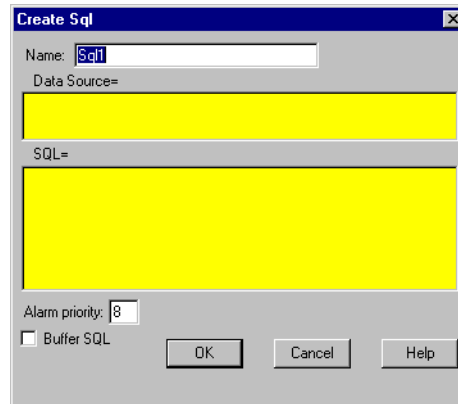

**Figure 2-81.** SqlExec Configuration Parameters Dialog Box

**Data Source** specifies the Data Source Name (DSN) as well as any other parameters needed by the ODBC driver to make the connection to the data source. For example if you want to connect to Excel 4.0, use:

```
"DSN=Excel Files; DBQ=C:\pathname;"
```

**SQL** is the SQL string you want to pass to the ODBC driver.

**Alarm Priority** determines the priority level of object-generated alarms.

**Buffer SQL** tells the SqlExec object to buffer any entries that fail for that object. An entry consists of the Data Source string and the SQL string. While Lookout does install a Lookout ODBC driver, you must manually create your own data source in order to access the Citadel database using ODBC. Consult Chapter 8, *Structured Query Language*, of the *Lookout Developer's Manual* for information on how to create your Lookout data source.



**Note** Some applications are not completely ODBC compliant. If you plan to use Microsoft Query, Microsoft Access, or Microsoft Visual Basic, ensure that the maximum column name length does not exceed 62 characters. These applications cannot handle longer names. Applications that are completely ODBC-compliant can handle names up to 126 characters long. All traces whose names exceed the maximum column name length are excluded from queries.

Because Lookout objects may include network path information in their names, and because you can arrange Lookout objects in hierarchies inside your processes, you may find it easy to exceed the 62 and 126 character limitations of ODBC. Consideration given to naming and organizing objects can minimize the risk of encountering this difficulty.

## SqlExec Data Members

**Table 2-67.** SqlExec Data Members

Data Member	Type	Read	Write	Description
c1 – c65535	numeric	yes	no	Value of the <i>n</i> th column in the row returned by ODBC.
c1.logical – c65535.logical	logical	yes	no	Value of the <i>n</i> th column in the row returned by ODBC.
c1.txt – c65535.txt	text	yes	no	Value of the <i>n</i> th column in the row returned by ODBC.
Execute	logical	no	yes	Executes the submitted SQL statement when it receives a change from low to high.
Failure	logical	yes	no	High if the last submitted query failed.
QueryString	text	yes	no	SQL Query String
ReadOnly	logical	yes	yes	If TRUE, opens the file in read only mode. If FALSE, opens the file in read write mode.
Status	logical	yes	no	High when the object is processing a query.

## SqlExec Comments

The placement of the data in the data members is determined by the SQL string. If you submit the SQL string

```
"select Album, Artist, NumTracks from cdTable
where NumTracks>5"
```

the return value for Album is contained in the data member `c1.txt`, Artist in `c2.txt`, and NumTracks in `c3`. This value is displayed according to the data member you choose—Text, Logical, or Numeric. If you connect both to `c1` and `c1.txt`, you are connecting to the same value twice. In these circumstances, the value is represented in a different form.

A select statement only returns the first row that it encounters with the matching criteria. An update statement updates all the rows it encounters with the matching criteria.

If you connect your SqlExec object to a timer that pulses faster than several times per second, Lookout may become so busy handling SQL queries that it becomes unresponsive to user input from the mouse or keyboard.

Comma Separated Value (CSV) files are supported in ODBC. You can append data to them using the SQL insert command, but you cannot update records using the SQL update command. This is a limitation of the CSV file format.

- Excel files are accessible through ODBC, but they do have some unusual properties.
- If you use SqlExec to update an Excel 5.0 or greater workbook, the workbook must be closed and have multi-user editing turned off.
- If you are just trying to read from a workbook using a select query, then multi-user editing can be on, and the file can be opened or closed.
- If you try to access an Excel 5.0 or greater workbook while it is open and multi-user editing is off, Lookout locks up until the Excel file is closed. This is caused by a problem in the Excel ODBC driver.
- If you are using Excel 4.0 you can update or read from the worksheet only when it is closed. If you try to access an Excel 4.0 worksheet while it is open, you will receive an alarm in Lookout.

Citadel is also accessible through ODBC, but is opened exclusively in read-only mode to protect the integrity of the data.

The following table lists a few sample DSN and SQL strings for connecting to different types of databases through ODBC. Notice that they differ

slightly from database to database. Remember that **Data Source** and **SQL** are expressions. If you enter a string into the expression box, the string must be properly set off by quotes. The strings in the following table appear exactly as you would type them into Lookout.

Database Type	Data Source String	SQL String
CSV	DSN=Text Files; DBQ= c:\ldev\ald2csv;	"select Priority," "Date & Time," "Description from alarm.csv where Priority = 4"
Excel 4.0	DSN=Excel Files; DBQ= c:\ldev\ald2csv;	select Priority," "Date & Time," "Alarm Codes (Set:Reset:Acknowledge", "Description from alarm.xls alarm where Priority = 4"
Excel 5.0	DSN=Excel Files;	"select Priority," "Date & Time," "Alarm Code (Set:Reset:Acknowledged)," "Description from Table1 where Priority = 4"
MS Access	DSN=MS Access 7.0 Database; DBQ=c:\My Documents\compact.mdb;	"select Title, AlbumID, Length from tracks where TrackID = 7"
Citadel	DSN=Citadel 4.0 database;	"select Interval, LocalTime," "Waves.Square" "from Traces where Interval = 0:1 and LocalTime >" "2/14/97 14:34:30"

## SQL Command Buffering

The `SQLExec` object can create a buffer for SQL commands so that commands are not lost if the connection to the database is temporarily lost. Buffering stores failed commands in a file so that they can be resubmitted once the connection to the database is reestablished.

If you check the **Buffer SQL** check box in the Create SQL dialog box, the object buffers entries that fail for the following reasons.

- Unable to connect to data source: error code 08001.
- Connection in use: error code 08002.



- Communication link failure: error code 08S01.
- Drivers SQLAllocEnv failed: error code IM004.
- Drivers SQLAllocConnect Failed: error code IM005.
- Unable to load translation DLL: error code IM009.

Entries are not buffered for any other error codes. This is to prevent entries that always cause an error from being buffered, such as a syntax error in an SQL string.

You should only enable buffering for SqlExec objects that are inserting new data into a database, such as an SQL insert command.

When entries are being buffered, they are buffered according to the data source with which they are trying to connect. This prevents an SqlExec object being buffered for an Excel data source from blocking an SqlExec object connected to an MS Access data source.

Separating the buffers by data source also keeps entries from different SqlExec objects trying to connect to the same data source in their proper chronological order.

If an SqlExec object has to buffer data, it keeps the data in a directory called `dsndata` in your Lookout data directory. The data is kept in a `.csv` file, you can view in Excel. Do not try to view these files while Lookout is running.

Once an object starts buffering, it buffers all subsequent entries to that data source for all objects that have buffering turned on. Because of this, an entry with a syntax or other error that should not be buffered, can be buffered. If this occurs, the buffering system discards that entry after the entry is passed to ODBC and ODBC returns an error. You are not notified when the entry is discarded.

If an object has buffering turned off, and that data source is currently being buffered, then that entry bypasses the buffer entirely. It then either succeeds or fails according to the state of the connection to the data source.

If a data source has buffered data, the buffering system automatically tries to reconnect to the data source periodically. Once it connects, it clears the buffer by periodically de-queuing the first few entries and sending them to ODBC.

During buffering, the **Failure** data member has a slightly different meaning. If it is high, then the first entry in the buffer failed and was kept

in the buffer. If it is low it means that the first entry in the buffer was successfully submitted to ODBC, and objects are still being buffered until the buffer can be cleared.

If you are creating and testing a process file, you may accumulate a large amount of buffered data in the `dsndata` directory. You can safely delete this directory when Lookout is *not* running. You will lose all the buffered data, but the SqlExec objects then loads with no errors or alarms.

## SqlExec Status Messages

### **ODBC Environment not allocated. No buffering will occur**

Indicates that memory could not be allocated for the connection to ODBC. This only occurs if your system is about to run out of memory. No buffering occurs if this alarm is set. Data that has already been buffered is not lost.

### **ODBC(32).DLL Not loaded**

Indicates that the DLL could not be loaded. No buffering can occur if this alarm is set. Data that has already been buffered, is not lost.

### **Data Source Name: Objects are being buffered for this data source**

This indicates which data sources are being buffered. Once the buffered entries have been cleared, the alarm ceases.

### **Incorrect data source string, check syntax**

This means that the Data Source string is missing the `DSN=driver name;` pair.

SqlExec displays any error messages that it receives from ODBC as an alarm. If the error is an error that should cause buffering, the status message indicates whether the entry was buffered or not buffered. Each message returned by ODBC belongs to the ODBC group. Some of the more common ODBC error messages are:

**[Not Buffered] 37000/-3100: [Microsoft][Driver Name] Syntax error in query expression ‘...’**

The SQL string has a syntax error in it.

**[Not Buffered] S1000/-1811 [Microsoft][Driver Name]Couldn't find file '(unknown)'**

This usually means that your data source expression is incorrect, or you have ODBC configured incorrectly for that data source expression, such as trying to connect to an Excel 5.0 workbook your ODBC Excel driver set up

for Excel 4.0 worksheets. Check the data source expression and the configuration of the ODBC driver.

**[Not Buffered] 42000/-1809 [Microsoft][Driver Name]can't update. Database or object is read-only.**

The file has been opened in read-only mode, but you are trying to write to it. If you have the data member **ReadOnly** set to TRUE, set it to FALSE. For some drivers, you can specify in the ODBC administration tool that all files opened by that driver should be opened in read-only mode. Check the ODBC configuration if you have **ReadOnly** set to FALSE and are still getting this error. For some ODBC drivers (such as Citadel) the file is always opened in read-only mode to protect the integrity of the files.

# Switch

Switch generates a logical signal for receipt by other objects. Switches change state when you click on them with a mouse button, trackball, touchscreen, or space bar on your keyboard.

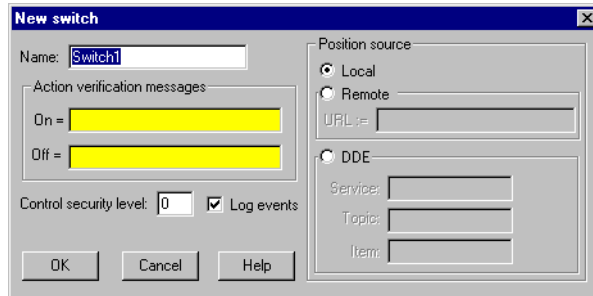

**Figure 2-82.** Switch Definition Parameters Dialog Box

Use **Action verification messages** to create dynamic text expressions to be displayed in message dialog boxes. See Chapter 6, *Security*, in the *Lookout Developer's Manual* for more information on security.

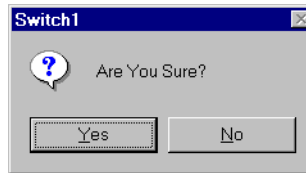

**Figure 2-83.** Verification Message Dialog Box

**Position source** determines where the value of the Switch resides. **Local** indicates the value of the Switch lies within the object itself—on the control panel. If the switch is up the signal is ON, if down the signal is OFF.

**Remote** Switches get their values from a remote source, often the register on a controller they are connected to. Flipping the Switch changes the status of the register, and changing the status of the register flips the switch.

The **Remote** option is especially useful when you want to prevent Lookout from changing the value of setpoints or registers upon initial startup, or reconnection of lost communication.

The **Remote** option calls for a URL to locate the data member you want to connect to. The URL field is green, and you cannot use a complex

expression as a URL. If you need to use one `RadioButton` for several purposes, you can use a Symbolic Link to make a more complex connection than that possible with a URL.

You can right-click in the **URL** field and use the **URL Editor** dialog box to assemble the URL, in the same way you use the Lookout expression editor.

A remote position source connection is completely reciprocal. A change in your Lookout control changes the data member that control is remoted to. Any change in that data member also changes the control. It is not necessary, and is incorrect, to use the **Edit Connections** dialog box to connect a control object to its controlled data member.

Because the remote connection is reciprocal, you can only make such a connection to a data member that is either writable, or readable and writable.

When a process with remoted controls first opens, those controls take their initial values by following the URL to read the data members they are remoted to. The control will be covered by a red X to indicate that the remote connection is not functioning.



**Note** You should use **Remote** to connect a control in a client process to a data member in a server process. Connections inside a single process can be made using **Object»Edit Connections**.

Because complex expressions are read-only values, you cannot remote directly to them. For the same reason, you cannot remote one control to another control's (`intrinsic`) data member (though you can remote a control to another control's value data member).

Much like Remote Switches, **DDE** (Dynamic Data Exchange) Switches get their values from a remote source. This could be a cell in a spreadsheet, another DDE aware application, or a second copy of Lookout running on the network. See Chapter 5, *Dynamic Data Exchange*, in the *Lookout Developer's Manual* for more information on **Service**, **Topic**, and **Item** parameters.

**Control security level** specifies the minimum security level operators must have to gain access to this individual object, and thus control it.

The **Log events** option creates a permanent audit trail for the object—who did what and when. All adjustments of the Switch are logged to disk, including the time the Switch was flipped, the operator's account name,

and the direction the Switch was flipped. See Chapter 7, *Logging Data and Events*, in the *Lookout Developer's Manual* for more information on event logging.

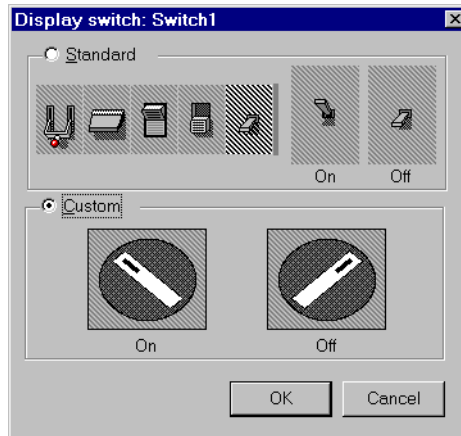

You can replace the standard switch types with custom graphic symbols. If you decide to use custom graphics, you must specify both symbol parameters, **On** and **Off**. See Chapter 2, *Graphics*, in the *Lookout Developer's Manual* for more information on creating custom graphic symbols and the use of transparent pixels.

## Switch Data Members

**Table 2-68.** Switch Data Members

Data Members	Type	Read	Write	Description
(implicit)	logical	yes	no	Switch Position
enable	logical	no	yes	If TRUE (the default), enables DDE. If FALSE, disables DDE. The default value is ON. This input is ignored for non-DDE TextEntry objects.
graphic1-graphicN	numeric	yes	no	Denotes which display of this object will appear on an HTML report. Only one display is available for the ActiveX object.

**Table 2-68.** Switch Data Members (Continued)

<b>Data Members</b>	<b>Type</b>	<b>Read</b>	<b>Write</b>	<b>Description</b>
reset	logical	no	yes	While this value equals TRUE, the control will be set to the value in <code>resetvalue</code> .
resetvalue	numeric	no	yes	Sets the value a control will take when the reset data member transitions from FALSE to TRUE.
snapdelay	numeric	yes	yes	Sets how long Lookout holds a control in a new position before snapping back to agree with an unchanged source.
value	numeric	yes	yes	The current value of the control. If you have removed this control, then <code>value</code> is the current value of the position source.
visible	logical	no	yes	When FALSE, the switch object cannot be seen on the display panel. When TRUE, the Switch can be seen and controlled.

**Comments** If a switch with more than two positions is needed, use a Pot object instead.

**Related Objects** [Pushbutton](#), [Pot](#)

## Symbolic Links

---

A Symbolic Link is a Lookout object you use to make certain kinds of remote connections easier and more efficient. This object can also be used to manage failover redundancy in Lookout 4. (Redundancy is not implemented in the Lookout 4 Preview.)

The Symbolic Link serves as a flexible intermediary between separate processes whether they are running on one computer or on different computers.

Create a Symbolic Link using the Lookout object browser. Right-click on the process or folder into which you want to insert the new Symbolic Link. The following dialog box appears.

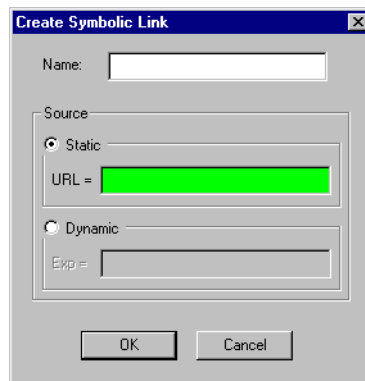

The Symbolic Link can represent either a static or a dynamic source. The **Static** source is a URL pointing to a computer, process, folder, or object running in some instance of Lookout on your network. A typical Symbolic Link set to a process appears in the following illustration.



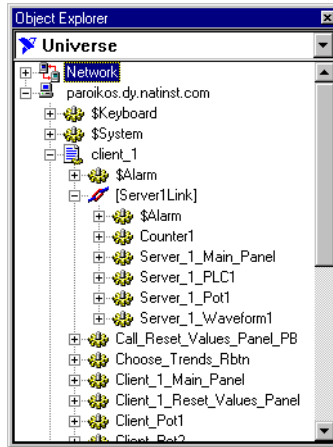

As you can see, all the objects in the `Server_1` process are represented in the Symbolic Link `[Link_to_Server1]`. You can drag and drop any of the objects or data members onto a panel in the process containing the Symbolic Link, where they will appear as expressions.

The **Dynamic** source must always be an expression that evaluates as a text string. When you select this option, you can use text strings and text variables to prepare the Symbolic Link to be used by a control for remote connections that cannot be made directly.

For example, you cannot use a complex expression in a Pot control remote source URL. You can, however, construct a complex expression as the dynamic source in a Symbolic Link, and then set the URL to connect to that Symbolic Link.

For instance, the following expression evaluates as two different URLs depending on the position of `Switch1` (line breaks inserted for clarity).

```
tif(Switch1,
    "\\.\server_1\Server_1_Waveform1.sinewave",
    "\\.\Server2\Server2_Waveform.sinewave")
```

If you connect a HyperTrend item to the Symbolic Link containing this dynamic source, changing the switch changes which server provides the wave form being plotted on the HyperTrend graph.

As another example, because Lookout data is now polymorphic, you can construct strings using both text and numeric inputs.

For example, if you create Pot1 with a **minimum** of 0, a **maximum** of 9, and an **interval** of 1, you can use the expression

```
"Modbus1.4001" & Pot1
```

as the entry for the **Dynamic** option in a Symbolic Link.

You can then use the Symbolic Link to connect a control to Modbus data members 40010-40019, depending on the setting of Pot1.

While you could not directly remote your control to that range of Modbus data members, you can make a remote connection from that control to the Symbolic Link using that dynamic expression.

If you connect the **Dynamic** expression to a data table, you have a nearly unlimited ability to have one object control a large number of data members, either through a cursor control or a radio button control.

## Symbolic Link Connection Persistence

If you use the Symbolic Link object to switch control between a number of different processes, you may have experienced some difficulty in the operation of certain remote source connections (related to the length of time Lookout keeps track of a Symbolic Link connection after you make a change). Lookout 4.0.1 features a default setting for persistence of values that should eliminate difficulty for most circumstances.

If necessary, you can change the time a Symbolic Link keeps track of values after you switch focus, though the need to make such an adjustment should be rare.

To change the default operation, create a [network] group in the Lookout.INI file and insert the key SymlinkCacheSeconds.

The default setting for the SymlinkCacheSeconds key is 600 (meaning 600 seconds, or 10 minutes). This is the time after a switch in focus for a Symbolic Link that Lookout will keep track of values from the previous Symbolic Link focus. If your Symbolic Link switches back to the original focus before the time expires, Lookout continues keeping track of values without interruption, and without having to reestablish connections.

See Appendix C, *.INI File Settings for Lookout*, in the *Lookout Developer's Manual* for more information on using the Lookout .INI file. You can also refer to the Lookout.INI file topic in Lookout Help for added information.

# \$System

---

\$System is a global object. It makes global Lookout data such as the currently logged in user name and security level available for use in your process. You can use \$System data members just like other object data members.

The **seclevel** data member is always an integer value between 1 and 10. This number represents the Lookout security level of the user currently logged in. For more information about Lookout security levels, see Chapter 6, *Security*, in the *Lookout Developer's Manual*.

The **time** data member represents the current date and time of the system. Like all time values in Lookout, this is a floating point number in which the integer represents the date and the fraction represents the time of day. You can use the various Lookout date and time numeric formats to view this value in the most convenient format. This data member updates itself every minute, on the minute. It also updates itself immediately after it is created or when its process is opened.

The **username** data member is the account name of the user currently logged in. For more information about Lookout security accounts, see Chapter 6, *Security*, in the *Lookout Developer's Manual*.

## \$System Data Members

**Table 2-69.** \$System Data Members

Data Member	Type	Read	Write	Description
NetworkStatus	text	yes	no	Reports the status of the last network transaction of your computer. You may need to use this data member in conjunction with a Sample object to keep track of high levels of network activity with many I/O points.
seclevel	numeric	yes	no	Security level of the user currently logged in
time	numeric	yes	no	Current operating system time
username	text	yes	no	Name of the user currently logged in

## TextEntry

With TextEntry you can manually enter textual notes with the keyboard. These notes may contain any combination of numeric and alphanumeric characters; however, the result of your entry is converted to a text value. Just like any other text expression in Lookout, your note can be logged to disk, connected to other data members that accept text signals, and so on. The note is saved and displayed as a multi-line entry, in which you can use carriage return. Click the » button to expand the field to multi-line size.

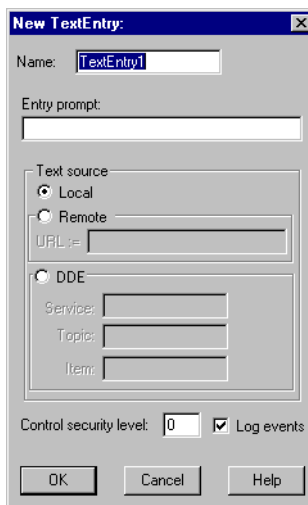

**Figure 2-84.** TextEntry Parameters Dialog Box

**Entry prompt** is the text that appears at the top of the text entry dialog box when an operator selects the text entry pushbutton.

**Text source** determines where the user-entered text resides. **Local** indicates the user-entered text lies within the object itself—on the control panel.

**Remote** indicates that the user-entered text resides in a remote source, such as a text expression or another TextEntry object.

The **Remote** option calls for a URL to locate the data member you want to connect to. The URL field is green, and you cannot use a complex expression as a URL. If you need to use one RadioButton for several purposes, you can use a Symbolic Link to make a more complex connection than that possible with a URL.

You can right-click in the **URL** field and use the **URL Editor** dialog box to assemble the URL, in the same way you use the Lookout expression editor.

A remote position source connection is completely reciprocal. A change in your Lookout control changes the data member that control is remoted to. Any change in that data member also changes the control. It is not necessary, and is incorrect, to use the **Edit Connections** dialog box to connect a control object to its controlled data member.

Because the remote connection is reciprocal, you can only make such a connection to a data member that is either writable, or readable and writable.

When a process with remoted controls first opens, those controls take their initial values by following the URL to read the data members they are remoted to. The control will be covered by a red X to indicate that the remote connection is not functioning.



**Note** You should use **Remote** to connect a control in a client process to a data member in a server process. Connections inside a single process can be made using **Object>Edit Connections**.

Because complex expressions are read-only values, you cannot remote directly to them. For the same reason, you cannot remote one control to another control's (intrinsic) data member (though you can remote a control to another control's value data member).

Much like **Remote** TextEntry objects, **DDE** TextEntry objects get their values from a remote source. This is the option you use to tie the text to a cell in a spreadsheet, a database lookup table, or any DDE aware application—including a second copy of Lookout running on the network. See Chapter 5, *Dynamic Data Exchange*, in the *Lookout Developer's Manual* for more detailed information on **Service**, **Topic** and **Item**.



**Note** The last DDE parameters used on any object automatically become the default values for any new DDE object.

**Control security level** specifies the minimum security level operators must have to gain access to this individual object, and thus control it.

The **Log events** option creates a permanent audit trail for the object—who did what and when. When selected, all text entries in this object are logged to disk. Each entry includes the time of the entry, the operator's account

name, and what entry was made. See Chapter 7, *Logging Data and Events*, in the *Lookout Developer's Manual* for more information on event logging.

Lookout presents the following display parameters dialog box after you define the object. It lets you define the text font and presentation style.

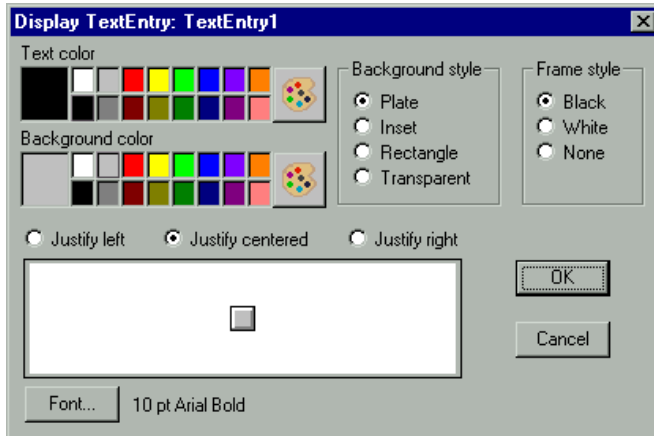

Figure 2-85. TextEntry Display Parameters Dialog Box

## TextEntry Data Members

Table 2-70. TextEntry Data Members

Data Members	Type	Read	Write	Description
(implicit)	text	yes	no	Current, user-entered text
enable	logical	no	yes	If TRUE (the default), enables DDE. If FALSE, disables DDE. The default value is ON. This input is ignored for non-DDE TextEntry objects.
graphic1-graphicN	numeric	yes	no	Denotes which display of this object will appear on an HTML report. Only one display is available for the ActiveX object.
reset	logical	no	yes	While this value equals TRUE, the control will be set to the value in resetvalue.

**Table 2-70.** TextEntry Data Members (Continued)

<b>Data Members</b>	<b>Type</b>	<b>Read</b>	<b>Write</b>	<b>Description</b>
resetvalue	numeric	no	yes	Sets the value a control will take when the reset data member transitions from FALSE to TRUE.
value	numeric	yes	yes	The current value of the control. If you have removed this control, then value is the current value of the position source.

## TimeOfxxxx

TimeOfxxxx are timers that generate a periodic pulse of a specified duration. The timers are turned on and off by **On/off signal**. The time period is defined by the type of timer used—a TimeOfMinute timer has a one-minute period, a TimeOfYear timer has a one-year time period, and so on. The output of these timers goes high after the specified **Timer offset** has elapsed in the current period and remains high for the specified **Timer duration**.

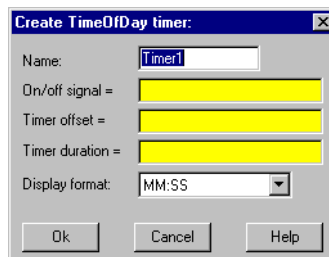

**Figure 2-86.** TimeOfDay Definition Parameters Dialog Box

The **Timer offset** and **Timer duration** can range from 0.0 seconds to a year, and the effective resolution is 0.01 seconds over the entire range. The **Timer offset** plus the **Timer duration** should always be less than or equal to the time period.

The object display shows the time remaining before the output changes state and is updated approximately once per second. It is shown in the selected **Display format**. If the **On/off signal** is OFF, the display shows OFF.

The **On/off signal** is a logical expression while **Timer offset** and **Timer duration** are numeric expressions. Normally, these are simple time constants such as 6:10:20 (six hours:ten minutes:twenty seconds). See *Numeric Data Members* in Chapter 2, *How Lookout Works*, in the *Getting Started with Lookout* manual for more information on entering time constants.



## Timeofxxxx Data Members

**Table 2-71.** TimeOfxxxx Data Members

Data Members	Type	Read	Write	Description
(implicit)	logical	yes	no	Logical timer value

**Comments** TimeOfxxxx can be used in place of Pulse objects when the pulse needs to be synchronized with the clock—if a pump should only be allowed to run between the hours of 8:00 and 17:00 each day, the TimeOfDay timer should be used.

**Related Objects** [DelayOff](#), [DelayOn](#), [Interval](#), [OneShot](#), [Pot](#)

# Trend

A Trend object displays a real-time trend graph on a control panel with any number of logical and numeric trend lines. The Trend graph scrolls from right to left, with current signal levels at the right end of the graph and the oldest values scrolling off the left end of the graph.

Unlike the HyperTrend, a Trend object can not display data from the Citadel Historical database. It can only display data in real time, therefore it is not necessary to log data to Citadel in order to display it on a Trend object. See the *HyperTrend* object class definition for more information on the HyperTrend.

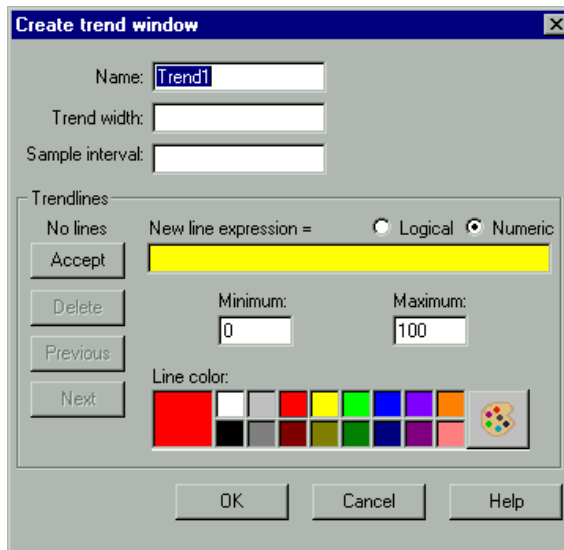

**Trend width** is the width of the graph in units of time. Graphs may have a width, or time span, of anywhere from two seconds to one year. The **Trend width** in the example dialog box indicates a time span of 1:00:00 or one hour. See *Numeric Data Members* in Chapter 2, *How Lookout Works*, of the *Getting Started with Lookout* manual for more information on entering time constants.

**Sample interval** specifies the frequency at which values are captured for plotting. The Trend object divides **Sample interval** into **Trend width** to determine how many data points to temporarily save for each trend line. Lookout stores these data points within the trend object, in RAM. For this reason, you should carefully choose **Sample interval**. Typically, no more

than 100 to 200 points need to be stored for each trend line, less for data that does not change rapidly. Because most computer display resolutions cannot take advantage of more than about 800 data points, it is rarely necessary to exceed that limit.

The **Trendlines** parameters are used to add, modify, or delete expressions from the trend graph. The data field to the right of the **Accept** button is used to enter logical and numeric expressions for plotting. The **Logical** and **Numeric** selections must be set to correspond with the current expression result.

**Line color** specifies the color of the trend line for the current expression.

**Minimum** and **Maximum** settings determine where on the trend graph the expression is plotted. **Minimum** is the bottom of the graph and **Maximum** is the top of the graph, regardless of the range of the expression. These settings create an imaginary vertical scale and affect each expression independently, so that you can plot trend lines on any section of a trend graph.

For example, take two numeric expressions, both of which range from 0 to 50. Set the **Minimum** and **Maximum** to 0 and 100 on the first expression, and  $-50$  and  $50$  on the second. The first expression is plotted in the bottom half of the chart while the second expression is plotted in the top half of the chart, even though they both fluctuate between 0 and 50.

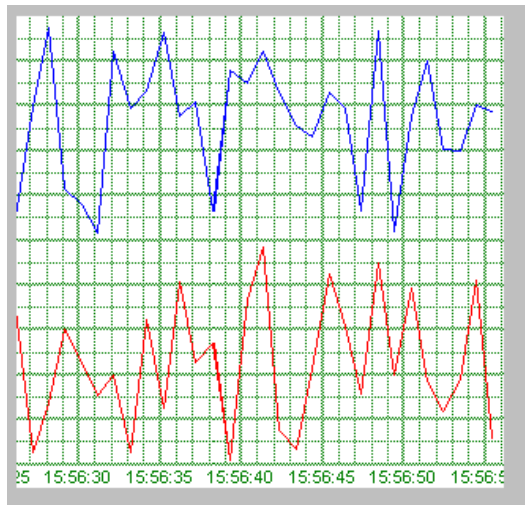

This shows the imaginary scale of the first expression, where min.=0 and max.=100. Because the expression ranges from 0 to 50, it is plotted in the bottom half of the graph.

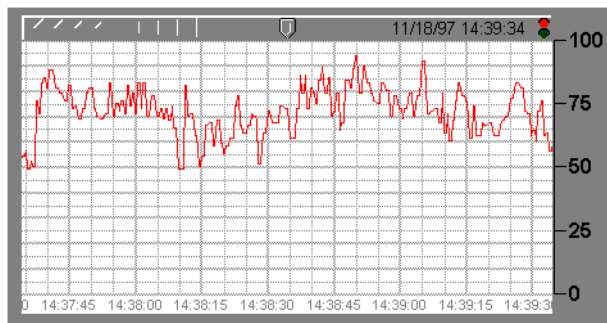

This figure shows the imaginary scale of the second expression, where min.=−50 and max.=50. Because the expression ranges from 0 to 50, it is plotted in the top half of the graph.

When both expressions are entered on a single trend graph, you get the following effect. Notice the custom scales on either end of the graph.

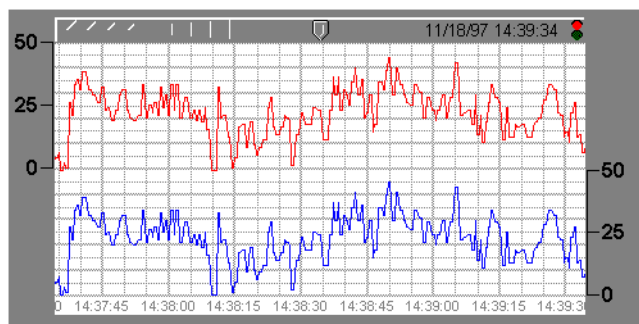

If **Logical** is selected for the expression type, the minimum and maximum settings change to **Position** and **Height**. These two values now represent a number between 0% and 100%, and determine the baseline location of the trend line and its unit height when the expression goes TRUE.

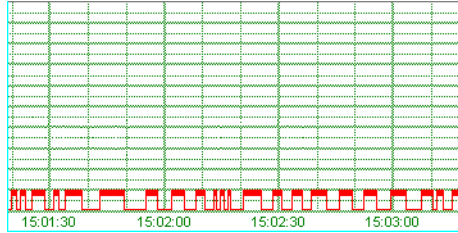

**Note** Full-height logical plotting is not available in the Trend object. For full-height logical plot display, use the HyperTrend object class.

When you finish entering or modifying the trend line parameters, click the **Accept** button. This adds the expression to the **Trendlines** list. The **Delete** button is used to delete the current expression from the trend graph. The **Previous** and **Next** buttons navigate through a list of the expressions named for the current trend object.

You can display trend graphs in various colors with different teeming styles and grid spacing. Right-click a trend object to modify the chart appearance.

**Timeline labels** determine where and how the date and time are to be displayed on the trend graph.

**Major increments** specifies the number of heavy horizontal grid lines on a trend graph. This value is independent of the range of any trend expressions.

**Minor increments** specifies the number of light horizontal grid lines between the major increment grid lines on a trend graph. This value is independent of the range of any trend expressions.

## Trend Data Members

**Table 2-72.** Trend Data Members

<b>Data Members</b>	<b>Type</b>	<b>Read</b>	<b>Write</b>	<b>Description</b>
graphic1—graphicN	numeric	yes	no	Denotes which display of this object will appear on an HTML report.
visible	logical	no	yes	When TRUE, the trend becomes visible on the control panel. When FALSE, the trend is invisible. The default value is TRUE.

Any number of trend lines can be displayed on a given trend, but too many lines can confuse the information you are trying to display. Consider this when deciding how many lines to show on one Trend.

Trends should usually be displayed with custom scales along the vertical axes. Trend displays are updated as quickly as once per second, depending on screen resolution, the size of the trend graph, and the trend width setting. Computers with slow display adapters may be slowed down considerably when a large trend graph is displayed that is being updated once per second. On slower computers with slow display cards (no graphics coprocessor), consider limiting the size of fast-moving Trends to less than one fourth the screen size.

Trend objects save trend line data points to the Lookout state file (.L4T) periodically as defined in the System Options dialog box, and any time you close your process file or exit Lookout. For this reason, you do not lose the plot lines shown on your trends if you exit Lookout or if your computer crashes.

# Waveform

The Waveform object generates cosine, sine, square, sawtooth, triangle, and random waveforms.

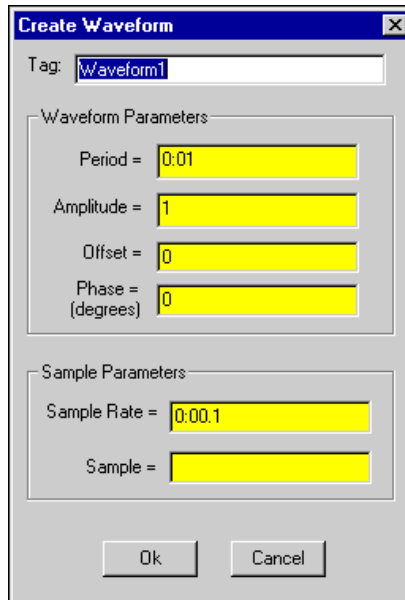

The Waveform object produces output by sampling the desired waveform at the specified **Sample Rate**. The **Period** (in days), **Amplitude**, **Offset** (level shift), and **Phase** (in degrees) of the generated waveforms can be set to any numerical expression. A single Waveform object can be used to generate multiple waveforms of varying relative phases, all with the same **Period**, **Amplitude**, **Offset** and absolute **Phase**.

Lookout samples a waveform when the logical expression **Sample** transitions from FALSE to TRUE. This can be a simple expression like the signal from a pushbutton, or it can be a complex algorithm.

**Sample Rate** is a numeric expression that determines how often to sample the waveform. Lookout converts the numeric value of **Sample Rate** into a time signal that represents days and fractions of a day. The Waveform object then samples the waveforms at the specified time interval. Normally, this will be a simple time constant such as 0:01 (one second).

When the **Period** of the waveform is changed, the waveform must be phase shifted so that there is a smooth transition to the new frequency. This is handled internally by the Waveform object and does not effect the **Phase** parameter.

As a result, multiple waveform objects will not be in phase with each other if one or more have had their **Periods** changed. To reset a waveform so that it will again be in phase with other waveforms, use the **Reset** connection. See *Waveform Comments* for a more detailed discussion of phase.

Each waveform output (except random) has 361 separate data members for generating waveforms of different relative phase shifts. For example, cosine0 (or just cosine) is a cosine wave of 0-degree relative phase shift, cosine90 is a cosine wave with +90 degrees relative phase shift, and cosine\_90 is a cosine wave with -90 degrees relative phase shift.

## Waveform Data Members

**Table 2-73.** Waveform Data Members

Data Members	Type	Read	Write	Description
cosine_180 — cosine180	numeric	yes	no	Cosine waveform output.
random	numeric	yes	no	Random waveform output.
Reset	logical	no	yes	Resets the phase shift to zero when changed from OFF to ON. (See comments on phase in Waveform Comments.)
Sample	logical	no	yes	When this transitions from false to true, the waveform is sampled.
SampleRate	numeric	no	yes	Specifies the rate at which the waveform will be automatically sampled.
saw_180 — saw180	numeric	yes	no	Sawtooth waveform output.
sine_180 — sine180	numeric	yes	no	Sine waveform output.
square_180 — square180	numeric	yes	no	Square waveform output.
triangle_180 — triangle180	numeric	yes	no	Triangle waveform output.



## Waveform Comments

A waveform is a function of time whose values repeat every period. The total phase shift of the waveform determines where, in its cycle, the waveform starts at time  $t = 0$  (midnight on the morning of the January 1, 1900 for Lookout). Two waveforms that start at the same place in their cycle at  $t = 0$  (that is, same total phase shift) are said to be “in phase” with each other.

For a waveform generated by a Waveform object, the total phase shift is equal to the absolute phase shift as specified by the **Phase** parameter, and by the relative phase shift specified by the selection of a particular data member (for example, cosine 90). Because the phase is defined in terms of absolute time, two waveform objects with the same **Period** and **Phase** will generate waveforms that are in phase with each other.

However, if the **Period** of one of the waveforms is variable (for example, if it is connected to a Pot object) and changes, the absolute phase of the waveform will be changed. This additional phase shift is handled internally by the Waveform object, and is only noticeable by the fact that it can produce an undesirable phase shift between two Waveform objects that have the same **Period**. For this reason, you may want to use the **Reset** data member to reset this internal phase shift.



**Note** The **Phase** parameter is in degrees. A **Phase** of 180 degrees will shift the waveforms one half period ahead. For example if the **Period** is 1 day and the **Phase** is 180 degrees, then the shift will be one-half day.

$$\frac{\mathbf{Phase}}{360^\circ} \times \mathbf{Period} = \frac{180^\circ}{360^\circ} \times 1 \text{ day} = \frac{1}{2} \text{ day}$$

# XBarR

The XBarR object class is one of the Lookout Statistical Process Control (SPC) tools and can play an important role in your Total Quality Management (TQM) program. This object class graphically displays an *X-Bar chart* and/or an *R chart* for a given signal. These control charts (also called mean and range charts, respectively) enable you to track your process to determine if it is about to go out of control and needs corrective attention.

**Figure 2-87.** XBarR Definition Parameters Dialog Box

The XBarR object reads the **Observed signal** value any time the **Observed trigger** transitions from OFF to ON. When the object collects the specified **Number of observations per sample** (2 – 25), it calculates the mean and range and plots them on their respective charts. Each chart plots the specified **Number of samples to display**.

**X-bar Chart limits** and **R Chart limits** can be specified or calculated, as you choose. The object continually calculates chart limits based on new samples as they are accumulated. These calculated limits enable you to track your process for a time to determine limit settings that your process is capable of operating within. Once you know what limits your process can normally handle, you can specify the chart limit parameters by entering them directly.

**LCL** and **UCL** chart limits identify the lower and upper control limits. These outer limits generally define the range of process acceptability. **CL** identifies the *centerline*. For the X-bar chart, the centerline is the mean

of sample means. For the R chart, the centerline is the average of the sample ranges.

You can display X-bar charts and R charts in various colors with different label styles and grid spacing.

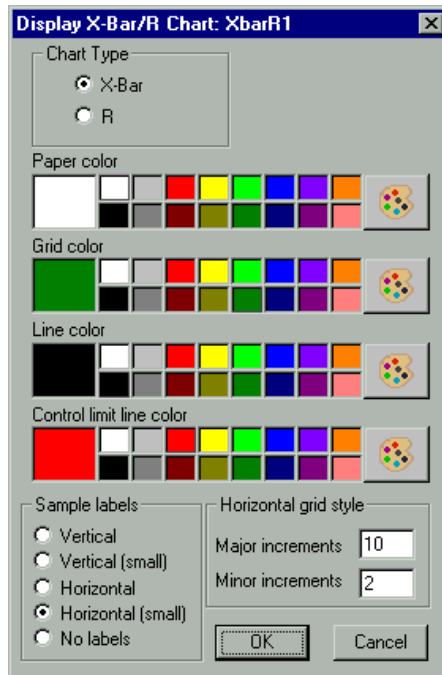

**Figure 2-88.** XBarR Display Parameters Dialog Box

When you enter the **LCL**, **UCL** and **CL** chart limit parameters for a chart, the entered values represent the limits shown on the chart. The following X-Bar Chart shows upper control limit, center line, and lower control limit entered as constants. The chart shows that the majority of the last 30 samples are running a bit under the centerline, suggesting that the process may need to be adjusted. The calculated control limits, shown below the graph, indicate new limits that might be used based on the current plotted samples.

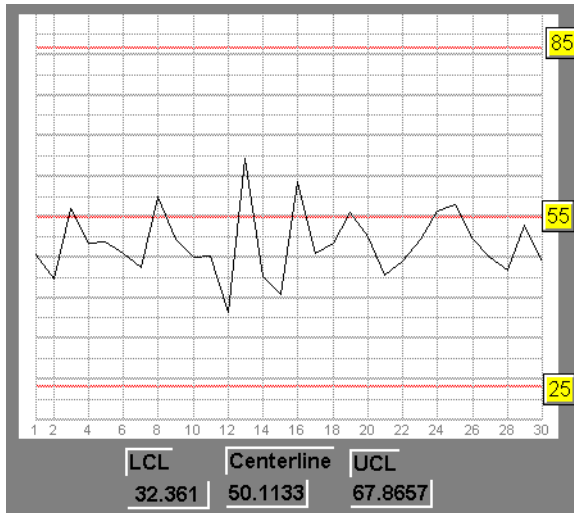

**Figure 2-89.** X-Bar Chart Showing Upper Control Limit, Center Line, and Lower Control Limits

If you leave one or more of the limit parameters blank for a chart in the definition parameters dialog box, the chart shows its *calculated* limits. As you can see in the following R chart, the calculated limits and the plotted limits are the same.

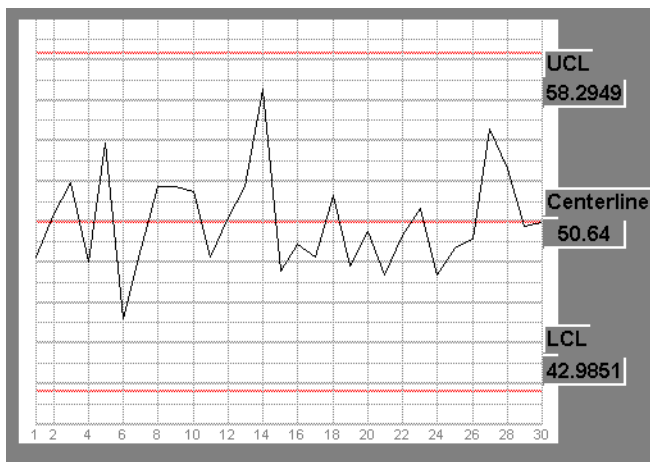

**Figure 2-90.** R Chart Showing Upper Control Limit, Center Line, and Lower Control Limits as Calculated Based on Plotted Samples

## XBarR Data Members

**Table 2-74.** XBarR Data Members

Data Members	Type	Read	Write	Description
graphic1-graphicN	numeric	yes	no	Denotes which display of this object will appear on an HTML report. Only one display is available for the ActiveX object.
R_ChartMax	numeric	yes	no	Identifies the top of the Range chart graph (the value of the plotted line when it is at 100 percent of the Y axis). The object recalculates this value as each new sample is read to ensure that the plotted line is always visible on the graph.
R_ChartMin	numeric	yes	no	Identifies the bottom of the Range chart graph (the value of the plotted line when it is at zero percent of the Y axis). The object recalculates this value as each new sample is read to ensure that the plotted line is always visible on the graph.
R_CL	numeric	yes	no	Centerline of range chart showing average of sample ranges calculated as follows: $\bar{R} = \frac{\sum_{i=1}^n R_i}{n}$
R_LCL	numeric	yes	no	Lower control limit of Range chart, calculated using the sampled data as follows: $LCL = D_3 \bar{R}$ <p>where <math>D_3</math> is from any standard 3-sigma control factors table</p>

**Table 2-74.** XBarR Data Members (Continued)

Data Members	Type	Read	Write	Description
R_Sample	numeric	yes	no	Calculated range, $R$ , of the last completed sample of observations, defined as the difference between the maximum and minimum observations in the sample.
R_UCL	numeric	yes	no	Upper control limit of Range chart, calculated using the sampled data as follows: $UCL = D_4 \bar{R}$ where $D_4$ is from any standard 3-sigma control factors table
Visible	logical	yes	yes	When TRUE, the X-bar and R charts become visible on the control panel. When FALSE, they are invisible. The default value is TRUE.
Xbar_ChartMax	numeric	yes	no	Identifies the top of the X-bar chart graph (the value of the plotted line if it is at 100 percent of the Y axis). The object recalculates this value as each new sample is read to ensure that the plotted line is always visible on the graph.
Xbar_ChartMin	numeric	yes	no	Identifies the bottom of the X-bar chart graph (the value of the plotted line if it is at zero percent of the Y axis). The object recalculates this value as each new sample is read to ensure that the plotted line is always visible on the graph.
Xbar_CL	numeric	yes	no	Centerline of X-bar chart showing the mean of sample means, calculated as follows: $\bar{\bar{x}} = \frac{\sum_{i=1}^n \bar{x}_i}{n}$

**Table 2-74.** XBarR Data Members (Continued)

Data Members	Type	Read	Write	Description
Xbar_LCL	numeric	yes	no	Lower control limit of X-bar chart, calculated as follows: $LCL = \bar{\bar{x}} - A_2 \bar{R}$ where $A_2$ is from any standard 3-sigma control factors table
Xbar_Sample	numeric	yes	no	Calculated mean of the last completed sample of observations, where $\bar{x} = \frac{\sum_{i=1}^n x_i}{n}$
Xbar_UCL	numeric	yes	no	Upper control limit of X-bar chart, calculated as follows: $UCL = \bar{\bar{x}} + A_2 \bar{R}$ where $A_2$ is from any standard 3-sigma control factors table

**Related Objects** [Average](#), [Histogram](#), [Maximum](#), [Minimum](#), [Sample](#)

**Related Functions** Avg, Max, Min, Stdev, Stdevp, Sum, Var, Varp  
Refer to the *Lookout Developer's Manual* for more information.

# XChart

The XChart object class graphically plots the value of an observed signal on a chart in response to a trigger signal.

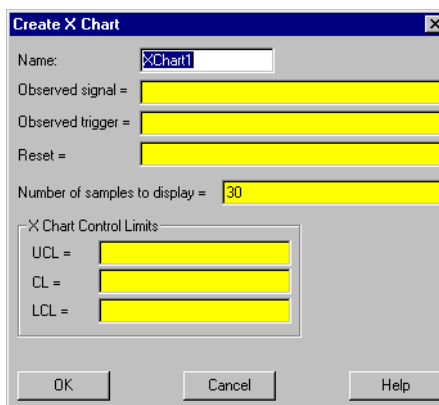

**Figure 2-91.** XChart Definition Parameters Dialog Box

The XChart object reads the value of the **Observed signal** any time the **Observed Trigger** transitions from OFF to ON.

Xchart plots the specified **Number of samples to display**. When it reaches the limit set by that parameter, it removes the oldest point before plotting the newest one. **Number of samples to display** must be between 2-4000. All the points on the chart are cleared any time **Reset** transitions from OFF to ON.

**XChart Control Limits** can be specified or calculated as you choose. If you leave the values in this section of the dialog box open, the object continually calculates chart limits based on new values as they are accumulated. You can watch your process for a time with XChart calculating limits to determine the ranges of normal operation, and then you can set the chart limits directly. Once set, XChart displays limit lines at the specified settings.

**UCL** and **LCL** identify the upper and lower control limit lines. **CL** defines the centerline.



You can display Xcharts in various colors and styles with different vertical and horizontal grid spacing.

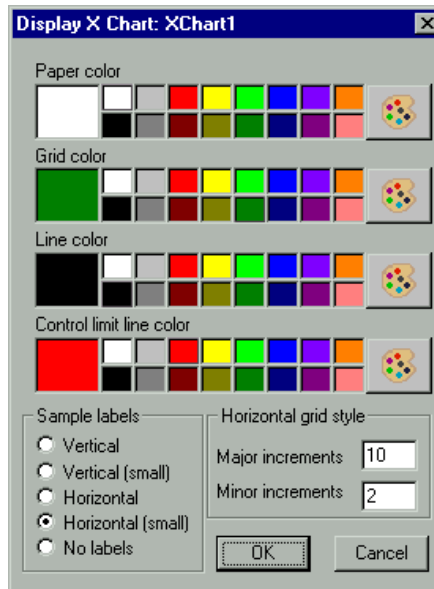

Figure 2-92. XChart Display Parameters Dialog Box

## XChart Data Members

Table 2-75. XChart Data Members

Data Members	Type	Read	Write	Description
ChartMax	numeric	yes	no	Identifies the top of the chart graph (the value of the plotted line when it is at 100 percent of the Y axis)
ChartMin	numeric	yes	no	Identifies the bottom of the chart graph (the value of the plotted line when it is at zero percent of the Y axis)

Table 2-75. XChart Data Members (Continued)

Data Members	Type	Read	Write	Description
CL	numeric	yes	no	Centerline of the chart, showing the mean of the sample, calculated by the formula:  $CL = \frac{\sum_{i=1}^n x_i}{n}$
graphic1-graphicN	numeric	yes	no	Denotes which display of this object will appear on an HTML report. Only one display is available for the ActiveX object.
LCL	numeric	yes	no	Lower control limit of the chart (3 standard deviations below CL), calculated by the formula:  $LCL = CL - 3 \sqrt{\frac{\sum_{i=1}^n (x_i)^2 - \frac{\left(\sum_{i=1}^n x_i\right)^2}{n}}{n-1}}$
Sample	numeric	yes	no	Value of the last sample recorded

**Table 2-75.** XChart Data Members (Continued)

Data Members	Type	Read	Write	Description
UCL	numeric	yes	no	<p>Upper control limit of chart. When calculated, is drawn 3 standard deviations above CL, using the following formula:</p> $UCL = CL + 3 \sqrt{\frac{\sum_{i=1}^n (x_i)^2 - \frac{\left(\sum_{i=1}^n x_i\right)^2}{n}}{n-1}}$
Visible	logical	yes	yes	<p>When TRUE, XChart become visible on the control panel. When FALSE, XChart is invisible. The default value is TRUE.</p>

# XYChart

The XYChart object class graphically plots X and Y points on a chart in response to a trigger signal.

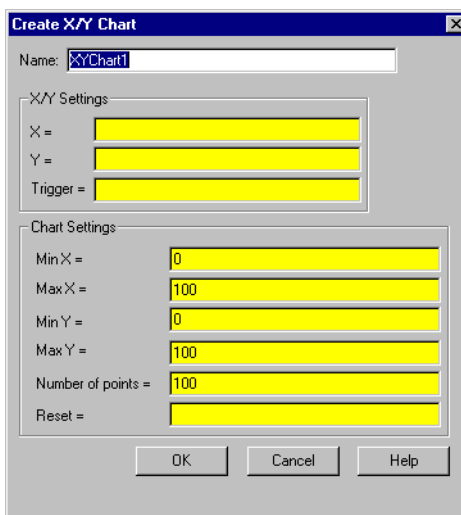
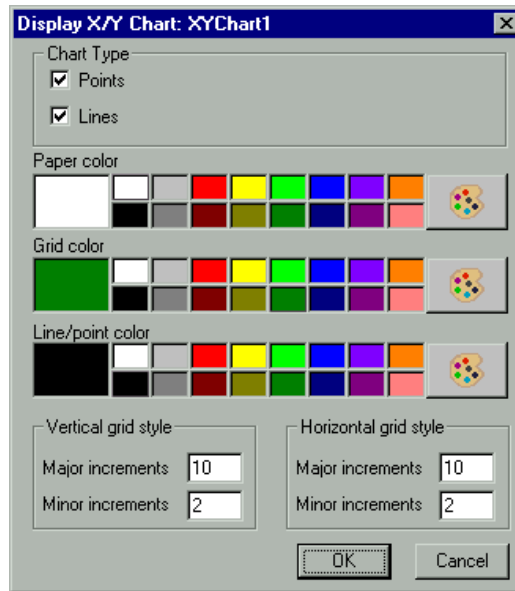

**Figure 2-93.** XYChart Definition Parameters Dialog Box

The XYChart object reads the value of the **X** and **Y** signals any time **Trigger** transitions from OFF to ON and plots the corresponding X/Y point on the chart in relation to the chart ranges **Min X**, **Max X**, **Min Y**, and **Max Y**.

XYChart plots the specified **Number of points**. When it reaches that limit, it removes the oldest point before plotting the newest one. **Number of points** must be between 2-4000. All the points on the chart are cleared any time **Reset** transitions from OFF to ON.

You can display X/Y charts in various colors and styles with different vertical and horizontal grid spacing.



**Figure 2-94.** XYChart Display Parameters Dialog Box

## XYChart Data Members

**Table 2-76.** XYChart Data Members

Data Members	Type	Read	Write	Description
ChartXMax	numeric	yes	no	Identifies the right most point of the chart graph (the value of the plotted line when it is at 100 percent of the X axis).
ChartXMin	numeric	yes	no	Identifies the left most point of the chart graph (the value of the plotted line when it is at zero percent of the X axis).
ChartYMax	numeric	yes	no	Identifies the top of the chart graph (the value of the plotted line when it is at 100 percent of the Y axis).

**Table 2-76.** XYChart Data Members (Continued)

<b>Data Members</b>	<b>Type</b>	<b>Read</b>	<b>Write</b>	<b>Description</b>
ChartYMin	numeric	yes	no	Identifies the bottom of the chart graph (the value of the plotted line when it is at zero percent of the Y axis).
graphic1-graphicN	numeric	yes	no	Denotes which display of this object will appear on an HTML report. Only one display is available for the ActiveX object.
Visible	logical	yes	yes	When TRUE, X/Y chart become visible on the control panel. When FALSE, it is invisible. The default value is TRUE.

---

## Lookout Driver and Protocol Objects

This chapter describes Lookout Driver and protocol object classes, listed in alphabetical order. Input parameter syntax and data members are documented for each object class, along with a description of the functionality of each object class.

# AB-Logix

## AB\_PLC2, AB\_PLC5, AB\_SLC500

---

Lookout uses the AB object classes to communicate with the Allen-Bradley family of PLC controllers using a variety of interfaces.

Lookout can communicate with a member of the PLC-2 family in the following ways:

- Through a Data Highway Plus (DH+) connection to an Allen-Bradley 1785-KA3 PLC-2 adapter module using an Allen-Bradley 1784-KT, 1784-KTx, or 1784-PCMK card, or an S-S Technologies 5136-SD direct-link interface card installed in the computer,
- Through the serial port using an Allen-Bradley KF2 module (which converts serial DF1 to DH+) to an Allen-Bradley 1785-KA3 PLC-2 adapter module, or
- Through a direct DF1 serial connection to the PLC programming port.

Lookout can communicate with a member of the PLC-5 family in the following ways:

- Through a direct Ethernet connection to the PLC AUI port,
- Through a direct DH+ connection using a 1784-KT, 1784-KTx, 1784-PCMK, or 5136-SD card installed in the computer,
- Through the serial port via a KF2 module which converts serial DF1 to DH+, or
- Through a direct DF1 serial connection to the PLC programming port.

Lookout can communicate with a member of the SLC-500 family in the following ways:

- Through a direct DH+ connection using a 1784-KT, 1784-KTx, 1784-PCMK, or 5136-SD card installed in the computer,
- Through the serial port via a KF2 module which converts serial DF1 to DH+,
- Through the serial port using an Allen-Bradley 1747-KE card (which plugs into the SLC chassis and converts DF1 to DH 485),
- Through the serial port using a stand-alone Allen-Bradley 1770-KF3 communication interface module which converts DF1 to DH 485,



- Through a direct DF1 serial connection to a SLC 5/03 or SLC 5/04 programming port, or
- Through a direct DH485 connection using a 1784-PCMk card in conjunction with either a 1747-AIC or 1761-NET-AIC module.

Lookout can communicate with MicroLogix 1500 through a client DF/serial connection to the PLC.

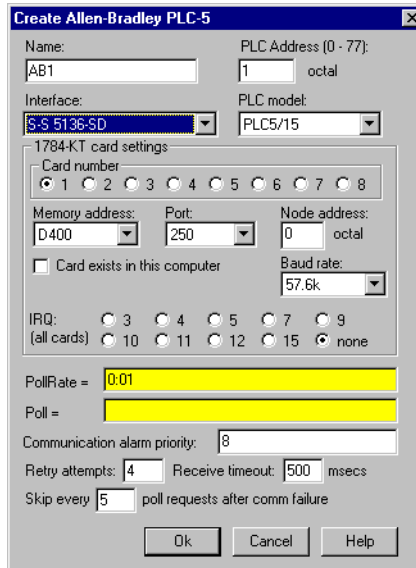

**Figure 3-1.** Allen-Bradley Parameter Dialog Box

**PLC Address** refers to the PLC network node address setting as configured on the physical device. If devices share a common **Interface**, they require unique addresses. When using DF1 protocol (serial communications), valid addresses range from 0 to 254 decimal. When using DH+, valid addresses range from 0 to 77 octal.

**PLC Model** specifies the particular type of PLC or SLC you are representing with this object. The **PLC Model** you select determines what native data members comprise the object.

**PollRate** is a numeric expression that determines how often to poll the device. Lookout polls the device at the specified time interval. Normally, this is a simple time constant such as 0:01 (one second). See *Numeric Data Members* in Chapter 2, *How Lookout Works*, of the *Getting Started with Lookout* manual for information on entering time constants.

**Poll** is a logical expression. When this expression changes from false to true, Lookout polls the device. You can use a simple expression like the signal from a pushbutton, or a complex algorithm.

**Communication alarm priority** determines the priority level of the alarms generated by the AB object.

**Retry attempts** specifies the consecutive number of times Lookout attempts to establish communications with a device if it is not getting a valid response. After it tries the number of **Retry attempts** specified, the object generates an alarm and begins to **Skip every *n* poll requests after comm failure**. Once Lookout reestablishes communications, it polls the device on its regular cycle, as defined by **PollRate**.

**Receive timeout** is the time delay Lookout waits for a response from a device before retrying the poll request.

**Interface** identifies the type of communication hardware you are using. The selection you make here determines what protocol parameters you have to specify. The paragraphs that follow describe interface-specific protocol parameters.

## Allen-Bradley Serial Port Interface Parameters

The `KE/KF/Serial` **Interface** selection enables serial port communication via a KE card, a KF3 module or KF2 module. When using your serial port, Lookout employs the Allen-Bradley full-duplex (peer-to-peer) DF1 protocol. Figure 3-1 shows an Allen Bradley object configured for serial communications.

**Serial port** specifies which RS-232C port the object uses for communication to the physical device.

**Data rate**, **Parity**, and **Error detection** reference the settings on the hardware device. The AB object classes support both *BCC* (block check character) and *CRC* (cyclic redundancy check) error detection. *BCC* provides a medium level of data security. *CRC* ensures a higher level of data security. Choose the settings as configured on your PLC or SLC.

**Phone number** specifies the number to be dialed if the serial port setting is configured for dial-up. This number only applies to the individual object.

## Allen-Bradley DH+ Interface Parameters



**Note** When you configure an AB\_PLC2, AB\_PLC5, or AB\_SLC500 for DH+, Lookout creates a file called ALLBRAD.INI. This file contains the configuration settings that you enter for your KT card(s). If you plan to run the process file on a Lookout Runtime System, be sure to copy the INI file along with your process (.1kp) file to the target computer.

The 1784-KT, 1784-KTx, 1784-PCMK, and S-S 5136-SD **Interface** selections enable direct connection of your computer to a DH+ network. The following illustration shows an AB\_SLC500 configured for DH+ communications using a 1784-KTx card.

**Figure 3-2.** AB\_SLC-500 Definition Parameters Dialog Box Configured for DH+ Communications

**Card number** selects which network interface card that the PLC is connected to in case your computer has multiple KT or S-S cards.

**Card DH+ node address** identifies the address of the interface card in the DH+ network. Valid addresses range from 0 to 77 octal. The node address of the card must be unique—that is, it must not be the same as the address of any other device on the DH+ network.

**Memory address** specifies the base address location of the selected interface card memory. Your selection should match the settings on the card. If you are using multiple interface cards, be sure each card has a

unique address. The network interface cards use dual-ported memory. For this reason, if you are using a memory manager such as EMM386 it is important to add a memory exclusion statement to your `CONFIG.SYS` file. The table on the following page lists base memory address selections and corresponding exclusions for all legal memory addresses for the 1784-KT card.

Use **Max node address** to maximize the performance of a DH485 network by assigning addresses to nodes on the network using consecutive numbers starting with zero. Set the **Max node address** to the maximum of the assigned node addresses. By default, the value of this variable is 31, which is the largest legal address for any node on a DH485 network.

The 1784-KT interface card has on-board network termination resistors. If you are using such a card and if your computer is the last node on the network and if the cable does not already have a terminating resistor on it, then select the **Enable link termination resistor** check box.

Use the **Card exists in this computer** check box to instruct Lookout whether or not to look for the interface card in the computer. *Be sure to check this box when you are ready to start polling your PLCs.* When you check this box and select **OK**, Lookout initializes the card, activates its self-test, and downloads its driver firmware. Then polling begins. Leave the **Card exists in this computer** check box deselected (this is the default setting) if the card is not in your computer (for example, if you are developing a process on a computer different from the one that will be running the process) or if you do not want to poll any PLC connected to the card.

If you deselect the **Card exists in this computer** check box, you are disabling communications using this interface card with all PLCs connected to it.

**Table 3-1.** Allen-Bradley DH+ Interface Memory Addresses

Memory Address	AB 1784-KT Exclude	AB 1784-KTx 1784-PCMK Exclude	SS-5136-SD Exclude*	Recommendation
A000	A300-A3FF	A000-A0FF	A000-A3FF	Typically used by VGA drivers. Use if no other option is available.
A400	A700-A7FF	A400-A4FF	A400-A7FF	
A800	AB00-ABFF	A800-A8FF	A800-ABFF	
AC00	AF00-AFFF	AC00-ACFF	AC00-AFFF	
B000	B300-B3FF	B000-B0FF	B000-B3FF	Used by MDA & CGA drivers. Use if no Dxxx option is available.
B400	B700-B7FF	B400-B4FF	B400-B7FF	
B800	BB00-BBFF	B800-B8FF	B800-BBFF	
BC00	BF00-BFFF	BC00-BCFF	BC00-BFFF	
C000	C300-C3FF	C000-C0FF	C000-C3FF	Typically used by BIOS. Use if no Dxxx option is available.
C400	C700-C7FF	C400-C4FF	C400-C7FF	
C800	CB00-CBFF	C800-C8FF	C800-CBFF	
CC00	CF00-CFFF	CC00-CCFF	CC00-CFFF	
D000	D300-D3FF	D000-D0FF	D000-D3FF	Normally available. Try to use one of these first.
D400	D700-D7FF	D400-D4FF	D400-D7FF	
D800	DB00-DBFF	D800-D8FF	D800-DBFF	
DC00	DF00-DFFF	DC00-DCFF	DC00-DFFF	
* The 5136-SD memory exclusions recommended here are based on 16K memory mapping. Because you are using the SS card to emulate the KT card, there is no advantage to using its 32K memory access capability.				

**Baud rate** (1784-KTx, 1784-PCMK, 5136-SD only) selects the baud rate of the DH+ network. The default is 57.6k baud. Before selecting a higher baud rate, be aware of that only a few PLCs (such as the SLC5/04) support higher baud rates; that every node on a DH+ network must support the baud rate used on that network; that the maximum network cable length is smaller for higher baud rates; and that the correct values for the termination resistors at the ends of the network cable are different for higher baud rates. Consult the manuals that came with your hardware for more detailed information.

IRQ (all cards) identifies the interrupt setting of all DH+ interface cards installed in the computer. This selection should match the IRQ settings on *all* of the interface cards.

Assigning an interrupt to the interface card(s) improves overall computer performance somewhat. Any time one of the cards receives an input, it generates an interrupt recognized by Lookout.



**Caution** Be sure to verify that no other drivers or cards are mapped to the selected memory address or use the same interrupt.

## Allen-Bradley Ethernet Interface Parameters

The Ethernet **Interface** selection enables direct communication between your computer and a PLC using a standard Ethernet network. The following diagram shows an AB\_PLC5 configured for Ethernet communications.

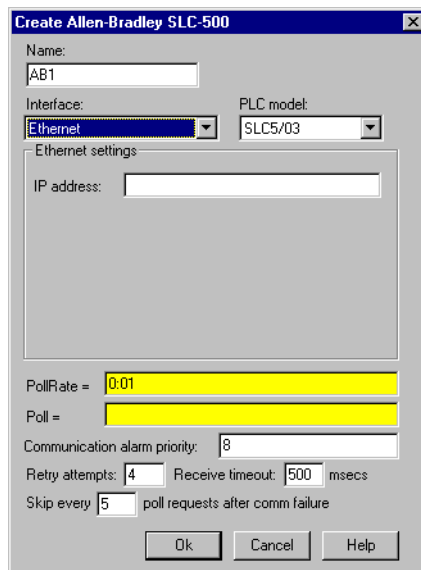

**Figure 3-3.** AB\_PLC5 Definition Parameters Dialog Box Configured for Ethernet Communications

**IP address** specifies the Internet protocol address of the PLC. An Internet protocol address consists of four numbers, separated by periods. Each number ranges from zero to 255 decimal. Thus, a typical Internet address might be 128.7.9.231. Ensure that the **IP address** you enter matches the

Internet protocol address of the PLC your object represents. You can also enter the IP address by name.

## Using the 5136-SD card from S-S Technologies, Inc.

To use the 5136-SD card, select the S-S 5136-SD interface in the **Create Object** dialog box. It is not necessary to run the `sdinst.exe` program that ships with the card because Lookout downloads the KT-emulation module automatically as part of the initialization process. It is, however, necessary to tell Lookout the port address specified by the switch settings on the card.

The screenshot shows the 'Create Allen-Bradley PLC-5' dialog box with the following configuration:

- Name: AB1
- PLC Address (0 - 77): 1 octal
- Interface: S-S 5136-SD
- PLC model: PLC5/15
- 1784-KT card settings:
  - Card number: 1
  - Memory address: D400
  - Port: 250
  - Node address: 0 octal
  - Card exists in this computer:
  - Baud rate: 57.6k
  - IRQ: none
- PollRate = 0:01 (highlighted in yellow)
- Poll = (highlighted in yellow)
- Communication alarm priority: 8
- Retry attempts: 4
- Receive timeout: 500 msec
- Skip every 5 poll requests after comm failure

**Figure 3-4.** AB\_PLC5 Definition Parameters Dialog Box Configured for the 5136-SD card

## Allen-Bradley Register Addressing

Lookout has adopted a sequential, flat addressing scheme for the Allen-Bradley PLCs. The addresses are sequential by data type, having nothing to do with the actual slot number. For example, consider the following slot configuration:

PLC slot Location	Type of Module in PLC Slot	Channel Address in Lookout
slot 1	16 channel analog input	I:0-I:16
slot 2	16 channel analog output	O:0-O:16
slot 3	8 channel input, 8 channel output	I:17-I:24, O:17-O:24
slot 4	16 channel analog input	I:25-I:32

You can see from the example, the slot number of the module is irrelevant to Lookout, and the input channels follow consecutive numbers as the output channels follow their own consecutive numbers.

## Allen-Bradley Data Members

Each AB object contains a great deal of data. All readable and writable members (inputs/outputs) are bundled with the object. As soon as you create an AB object you immediately have access to all the object data members.

The AB object classes automatically generate an efficient read/write blocking scheme based on the inputs and outputs you are using in your process file. You are not required to build your own I/O blocking table. However, you can ensure peak performance by organizing your PLC data into contiguous groups.

**Table 3-2.** AB MicroDenotes which display of this object will appear on an HTML report. Logix Data Members

Data Member	Type	Read	Write	Description
B:0 - B255:255	numeric	yes	yes	16-bit signed binary word ranging from -32,768 to +32,767.
B:0_0-B255:255_15	logical	yes	yes	One bit within a 16-bit binary word.



**Table 3-2.** AB MicroDenotes which display of this object will appear on an HTML report. Logix Data Members (Continued)

<b>Data Member</b>	<b>Type</b>	<b>Read</b>	<b>Write</b>	<b>Description</b>
B_0 - B255_4095	logical	yes	yes	One bit within the specified data file. For example, B3_32 specifies datafile 3, word 2, bit 1.
C:0.ACC - C255:255.ACC	numeric	yes	yes	Counter accumulated value. Two-byte signed word ranging from -32,768 to +32,767.
C:0.PRE - C255:255.PRE	numeric	yes	yes	Preset counter value. Two-byte signed word ranging from -32,768 to +32,767.
C:0_CU - C255:255_CU	logical	yes	yes	Counter up-enable bit.
C:0_DN - C:255:255_DN	logical	yes	yes	Counter done bit.
C:0_OV - C255:255_OV	logical	yes	yes	Counter overflow bit.
C:0_UA - C255:255_UA	logical	yes	yes	Counter update accumulation bit (HSC in fixed controller only).
C:0_UN - C255:255_UN	logical	yes	yes	Counter underflow bit.
C:0_CD - C255:255_CD	logical	yes	yes	Counter down-enable bit.
CommFail	logical	yes	no	Object-generated signal that is ON if, for any reason, Lookout cannot communicate with the PLC.
I:0 - I:30	numeric	yes	yes	Unsigned 16-bit input value ranging from 0 to 65,535.
I:0_0 - I:30_15	logical	yes	yes	One bit within a 16-bit input word.
N:0 - N255:255	numeric	yes	yes	16-bit signed integer value ranging from -32,768 to +32,767.
N:0_0 - N255:255_15	logical	yes	yes	One bit within a 16-bit signed integer word.

**Table 3-2.** AB MicroDenotes which display of this object will appear on an HTML report.Logix Data Members (Continued)

Data Member	Type	Read	Write	Description
O:0 - O:30	numeric	yes	yes	Unsigned 16-bit output value ranging from 0 to 65,535
O:0_0 - O:30_15	logical	yes	yes	One bit within a 16-bit output word.
OffHook	logical	no	yes	When TRUE, instructs the PLC to retain exclusive use of its assigned communication port. This prevents Lookout from hanging up between polls, saving the redial overhead. This also prevents other blocks from communicating over the same channel.
Poll	logical	no	yes	When transitioned from FALSE to TRUE, the Lookout object polls the PLC device.
PollRate	numeric	no	yes	Specifies the frequency at which the Lookout object polls the PLC device.
R:0_FD - R255:255_FD	logical	yes	yes	Control “found” single-bit logical indicator.
R:0.LEN - R255:255.LEN	numeric	yes	yes	Control “length” signed integer ranging from -32,768 to +32,767.
R:0.POS - R255:255.POS	numeric	yes	yes	Control “position” signed integer ranging from -32,768 to +32,767.
R:0_DN - R255:255_DN	logical	yes	yes	Control “done” single-bit logical indicator.
R:0_EM - R255:255_EM	logical	yes	yes	Control “empty” single-bit logical indicator.
R:0_EN - R255:255_EN	logical	yes	yes	Control “enable” single-bit logical indicator.
R:0_ER - R255:255.ER	logical	yes	yes	Control “error” single-bit logical indicator.
R:0_EU - R255:255_EU	logical	yes	yes	Control “enable unloading” single-bit.
R:0_IN - R255:255.IN	logical	yes	yes	Control “inhibit comparison” flag single-bit logical indicator.

**Table 3-2.** AB MicroDenotes which display of this object will appear on an HTML report. Logix Data Members (Continued)

<b>Data Member</b>	<b>Type</b>	<b>Read</b>	<b>Write</b>	<b>Description</b>
R:0_UL - R255:255_UL	logical	yes	yes	Control “unload” single-bit logical indicator.
S:0 - S:96	numeric	yes	yes	PLC status file containing a signed integer ranging from –32,768 to +32,767 (see Allen-Bradley documentation).
S:0_0 -S:96_15	logical	yes	yes	Individual PLC status bits (see Allen-Bradley documentation).
T:0.ACC - T255:255.ACC	numeric	yes	yes	Accumulated timer value ranging from –32,768 to +32,767.
T:0.PRE - T255:255.PRE	numeric	yes	yes	Preset timer value ranging from –32,768 to +32,767.
T:0_DN - T255:255_DN	logical	yes	yes	Timer “done” single-bit logical indicator.
T:0_EN - T255:255_EN	logical	yes	yes	Timer “enabled” single-bit logical indicator.
T:0_TT - T255:255_TT	logical	yes	yes	Timer “timing” single-bit logical indicator Update logical yes no Object-generated signal that pulses each time the object polls the device.

**Table 3-3.** AB\_PLC2 Data Members

<b>Data Member</b>	<b>Type</b>	<b>Read</b>	<b>Write</b>	<b>Description</b>
0 - 7777	numeric	yes	yes	16-bit signed binary word ranging from –32,768 to +32,767
0_0 - 7777_17	logical	yes	no	One bit within a 16-bit binary word
CommFail	logical	yes	no	Object-generated signal that is ON if, for any reason, Lookout cannot communicate with the PLC.

**Table 3-3.** AB\_PLC2 Data Members (Continued)

<b>Data Member</b>	<b>Type</b>	<b>Read</b>	<b>Write</b>	<b>Description</b>
OffHook	logical	no	yes	When true, instructs the PLC to retain exclusive use of its assigned communication port. This prevents Lookout from hanging up between polls, saving the redial overhead. This also prevents other blocks from communicating over the same channel.
Poll	logical	no	yes	When transitioned from false to true, the Lookout object polls the PLC device
PollRate	numeric	no	yes	Specifies the frequency at which the Lookout object polls the PLC device
Update	logical	yes	no	Object-generated signal that pulses each time the object polls the device

**Table 3-4.** AB\_SLC500 Data Members

<b>Data Member</b>	<b>Type</b>	<b>Read</b>	<b>Write</b>	<b>Description</b>
B:0 - B255:255	numeric	yes	yes	16-bit signed binary word ranging from -32,768 to +32,767
B:0_0-B255:255_15	logical	yes	yes	One bit within a 16-bit binary word
B_0 - B255_4095	logical	yes	yes	One bit within the specified datafile. For example, B3_32 specifies datafile 3, word 2, bit 1.
C:0.ACC - C255:255.ACC	numeric	yes	yes	Counter accumulated value. Two-byte signed word ranging from -32,768 to +32,767
C:0.PRE - C255:255.PRE	numeric	yes	yes	Preset counter value. Two-byte signed word ranging from -32,768 to +32,767
C:0_CU - C255:255_CU	logical	yes	yes	Counter up-enable bit.
C:0_DN - C:255:255_DN	logical	yes	yes	Counter done bit.
C:0_OV - C255:255_OV	logical	yes	yes	Counter overflow bit.

**Table 3-4.** AB\_SLC500 Data Members (Continued)

<b>Data Member</b>	<b>Type</b>	<b>Read</b>	<b>Write</b>	<b>Description</b>
C:0-UA - C255:255-UA	logical	yes	yes	Counter update accumulation bit (HSC in fixed controller only)
C:0-UN - C255:255-UN	logical	yes	yes	Counter underflow bit.
C:0-CD -C255:255_CD	logical	yes	yes	Counter down-enable bit.
CommFail	logical	yes	no	Object-generated signal that is ON if, for any reason, Lookout cannot communicate with the SLC.
F:0-F255:255	numeric	yes	yes	Floating point value
I:0 - I:30	numeric	yes	yes	Unsigned 16-bit input value ranging from 0 to 65,535
I:0_0 - I:30_15	logical	yes	yes	One bit within a 16-bit input word
N:0 - N255:255	numeric	yes	yes	16-bit signed integer value ranging from -32,768 to +32,767.
N:0_0 - N255:255_15	logical	yes	yes	One bit within a 16-bit signed integer word
O:0 - O:30	numeric	yes	yes	Unsigned 16-bit output value ranging from 0 to 65,535
O:0_0 - O:30_15	logical	yes	yes	One bit within a 16-bit output word
OffHook	logical	no	yes	When true, instructs the PLC to retain exclusive use of its assigned communication port. This prevents Lookout from hanging up between polls, saving the redial overhead. This also prevents other blocks from communicating over the same channel.
Poll	logical	no	yes	When transitioned from false to true, the Lookout object polls the SLC device
PollRate	numeric	no	yes	Specifies the frequency at which the Lookout object polls the SLC device

**Table 3-4.** AB\_SLC500 Data Members (Continued)

<b>Data Member</b>	<b>Type</b>	<b>Read</b>	<b>Write</b>	<b>Description</b>
R:0_FD - R255:255_FD	logical	yes	yes	Control “found” single-bit logical indicator
R:0.LEN - R255:255.LEN	numeric	yes	yes	Control “length” signed integer ranging from –32,768 to +32,767
R:0.POS - R255:255.POS	numeric	yes	yes	Control “position” signed integer ranging from –32,768 to +32,767
R:0_DN - R255:255_DN	logical	yes	yes	Control “done” single-bit logical indicator
R:0_EM - R255:255_EM	logical	yes	yes	Control “empty” single-bit logical indicator
R:0_EN -R255:255_EN	logical	yes	yes	Control “enable” single-bit logical indicator
R:0_ER - R255:255.ER	logical	yes	yes	Control “error” single-bit logical indicator
R:0_EU - R255:255_EU	logical	yes	yes	Control “enable unloading” single-bit
R:0_IN - R255:255.IN	logical	yes	yes	Control “inhibit comparison” flag single-bit logical indicator
R:0_UL - R255:255_UL	logical	yes	yes	Control “unload” single-bit logical indicator
S:0 - S:96	numeric	yes	yes	SLC status file containing a signed integer ranging from –32,768 to +32,767 (see Allen-Bradley documentation)
S:0_0 -S:96_15	logical	yes	yes	Individual SLC status bits (see Allen-Bradley documentation)
ST9:0 - ST255:255	text	yes	yes	String, limited to 83 characters in length. See the note on Allen-Bradley string data members at the end of this table.
T:0.ACC - T255:255.ACC	numeric	yes	yes	Accumulated timer value ranging from –32,768 to +32,767

**Table 3-4.** AB\_SLC500 Data Members (Continued)

Data Member	Type	Read	Write	Description
T:0.PRE - T255:255.PRE	numeric	yes	yes	Preset timer value ranging from -32,768 to +32,767
T:0_DN - T255:255_DN	logical	yes	yes	Timer “done” single-bit logical indicator
T:0_EN - T255:255_EN	logical	yes	yes	Timer “enabled” single-bit logical indicator
T:0_TT - T255:255_TT	logical	yes	yes	Timer “timing” single-bit logical indicator
Update	logical	yes	no	Object-generated signal that pulses each time the object polls the device



**Note** There is no Allen-Bradley default file type associated with strings. You must configure your Allen-Bradley device to have a string file. See your Allen-Bradley documentation for details on this configuration procedure.

The string data member only works with the SLC 500 Enhanced series of PLCs, including the SLC 5/03; OS301 and SLC 5/04., and with the PLC 5 Enhanced series, PLC 5/11, PLC 5/20, PLC 5/30, PLC 5/40, PLC 5/60, PLC 5/80.

**Table 3-5.** AB\_PLC5 Data Members

Data Member	Type	Read	Write	Description
B:0 - B999:999	numeric	yes	yes	16-bit signed binary word ranging from -32,768 to +32,767
B:0_0-B999:999_15	logical	yes	yes	One bit within a 16-bit binary word.
B_0 - For B999_15999	logical	yes	yes	One bit within the specified datafile; for example, B3_32 specifies datafile 3, word 2, bit 1.
C:0.ACC - C999:999.ACC	numeric	yes	yes	Counter accumulated value. Two-byte signed word ranging from -32,768 to +32,767
C:0.PRE - C999:999.PRE	numeric	yes	yes	Preset counter value ranging from -32,768 to +32,767.
C:0_CD - C999:999_CD	logical	yes	yes	Counter down-enable bit.

**Table 3-5.** AB\_PLC5 Data Members (Continued)

<b>Data Member</b>	<b>Type</b>	<b>Read</b>	<b>Write</b>	<b>Description</b>
C:0_CU - C999:999_CU	logical	yes	yes	Counter up-enable bit.
C:0_DN - C:999:999_DN	logical	yes	yes	Counter done bit.
C:0_OV - C999:999_OV	logical	yes	yes	Counter overflow bit.
C:0_UA - C999:999_UA	logical	yes	yes	Counter update accumulation bit (HSC in fixed controller only).
C:0_UN - C999:999_UN	logical	yes	yes	Counter underflow bit.
CommFail	logical	yes	no	Object-generated signal that is ON if, for whatever reason, Lookout cannot communicate with the PLC.
F:0-F999:999	numeric	yes	yes	Floating point value.
I:0 - I:277	numeric	yes	yes	Unsigned 16-bit input value ranging from 0 to 65,535.
I:0_0 - I:277_17	logical	yes	yes	One bit within a 16-bit input word (octal).
N:0 - N999:999	numeric	yes	yes	16-bit signed integer value ranging from -32,768 to +32,767.
N:0_0 - N999:999_15	logical	yes	yes	One bit within a 16-bit signed integer word.
O:0 - O:277	numeric	yes	yes	Unsigned 16-bit output value ranging from 0 to 65,535.
O:0_0 - O:277_17	logical	yes	yes	One bit within a 16-bit output word (octal).
OffHook	logical	no	yes	When true, instructs the PLC to retain exclusive use of its assigned communication port. This prevents Lookout from hanging up between polls, saving the redial overhead. This also prevents other blocks from communicating over the same channel.



**Table 3-5.** AB\_PLC5 Data Members (Continued)

<b>Data Member</b>	<b>Type</b>	<b>Read</b>	<b>Write</b>	<b>Description</b>
Poll	logical	no	yes	When transitioned from false to true, the Lookout object polls the PLC device.
PollRate	numeric	no	yes	Specifies the frequency at which the Lookout object polls the PLC device.
R:0.LEN - R999:999.LEN	numeric	yes	yes	Control “length” signed integer ranging from –32,768 to +32,767.
R:0.POS - R999:999.POS	numeric	yes	yes	Control “position” signed integer ranging from –32,768 to +32,767.
R:0_DN - R999:999_DN	logical	yes	yes	Control “done” single-bit logical indicator.
R:0_EM - R999:999_EM	logical	yes	yes	Control “empty” single-bit logical indicator.
R:0_EN - R999:999_EN	logical	yes	yes	Control “enable” single-bit logical indicator.
R:0_ER - R999:999.ER	logical	yes	yes	Control “error” single-bit logical indicator.
R:0_EU - R999:999_EU	logical	yes	yes	Control “enable unloading” single-bit logical indicator.
R:0_FD - R999:999_FD	logical	yes	yes	Control “found” single-bit logical indicator.
R:0_IN - R999:999.IN	logical	yes	yes	Control “inhibit comparison” flag logical indicator.
R:0_UL - R999:999_UL	logical	yes	yes	Control “unload” single-bit logical indicator.
S:0 - S:127	numeric	yes	yes	PLC status file containing a signed integer ranging from –32,768 to +32,767 (see Allen-Bradley documentation).
S:0_0 - S:127_15	logical	yes	yes	Individual PLC status bits (see Allen-Bradley documentation).

**Table 3-5.** AB\_PLC5 Data Members (Continued)

Data Member	Type	Read	Write	Description
ST9:0 - ST255:255	text	yes	yes	String, limited to 83 characters in length. See the note on Allen-Bradley string data members at the end of this table.
T:0.ACC - T999:999.ACC	numeric	yes	yes	Accumulated timer value ranging from -32,768 to +32,767.
T:0.PRE - T999:999.PRE	numeric	yes	yes	Preset timer value ranging from -32,768 to +32,767.
T:0_DN - T999:999_DN	logical	yes	yes	Timer “done” single-bit logical indicator.
T:0_EN - T999:999_EN	logical	yes	yes	Timer “enabled” single-bit logical indicator.
T:0_TT - T999:999_TT	logical	yes	yes	Timer “timing” single-bit logical indicator.
Update	logical	yes	no	Object-generated signal that pulses each time the object polls the PLC device.



**Note** There is no Allen-Bradley default file type associated with strings. You must configure your Allen-Bradley device to have a string file. See your Allen-Bradley documentation for details on this configuration procedure.

The string data member only works with the SLC 500 Enhanced series of PLCs, including the SLC 5/03; OS301 and SLC 5/04., and with the PLC 5 Enhanced series, PLC 5/11, PLC 5/20, PLC 5/30, PLC 5/40, PLC 5/60, PLC 5/80.

## Allen-Bradley Error Messages

AB objects report the statuses of commands they issue to AB devices. When Lookout receives a response from an AB device, it reads the status (STS) byte and, if necessary, the extended status (EXT STS) byte to verify the device executed the Lookout command properly. If the command was not executed properly, Lookout reports the failure as an alarm containing the status code and its meaning. The following is an example of such an alarm:

```
EXT STS = 0F: not enough levels in address
```

AB object classes can also generate alarms internally. The following is a list of AB alarms generated by Lookout, their descriptions, and possible responses. In the messages, *KT* is used to refer to any of the DH+ interface cards (1784-KT, 1784-KTx, 1784-PCMK, or 5136-SD) and *SS* is used to refer to the 5136-SD card.

**Cannot resolve ip address: *address***

The AB object failed to find any node on the network that corresponds to the given IP address. Confirm that the IP address entered in the **Modify Object** dialog box is correct.

**Cannot get session id from plc**

The AB object sent a message to the PLC requesting a TCP/IP session and failed to receive a satisfactory response.

**Cannot communicate with device (code=*dd*)**

The AB object timed out while waiting for a response (via TCP/IP) from the PLC. If the code is 0, the object timed out while trying to establish the TCP/IP connection; if the code is 1, the object timed out while waiting for a session id from the PLC; if the code is 2, the object timed out while waiting for a response to a poll request. Confirm that the IP address of the PLC has been entered correctly and that the PLC is reachable over the TCP/IP network.

**Download of file *sdipls.ss1* failed**

Lookout was unable to write the KT-emulation program file to the 5136-SD card physical memory. This could be due to either an invalid port or memory address or to a faulty or improperly seated card.

**Invalid memory address for card: *0xAAAA***

The memory address specified for the card (for example, D400) is not valid for this model of card. The address must be a multiple of 0x0100 and lie in the range 0xA000 to 0xDF00. Moreover, the KT, KTx, PCMK, and 5136-SD cards support different sets of valid memory addresses. See the documentation that shipped with the card for details.

**Invalid node address for card: *xx***

Node addresses must be between 0 and 63 decimal.

**Invalid port number for SS card: *0xPPP***

The port number specified for the 5136-SD card is invalid. See the documentation that shipped with the card for the list of valid port addresses.

### **Invalid port or memory address**

Lookout was unable to write to the 5136-SD card physical memory. This could be due to either an invalid port or memory address or to a faulty or improperly seated card.

### **KT card failed to find resources**

#### **KT card receive mailbox is in an invalid state**

#### **KT card send mailbox is in an invalid state**

You will probably never see one of these alarms. If you do, call National Instruments and ask for technical support.

### **KT card dual-ported memory test failed at location xxxx**

The interface card failed a memory test when it was first powered on. The memory test reads, writes and rereads the dual-ported memory to ensure memory access by the card. Verify that the card is configured for the memory address that you specified. Verify that your memory manager (like EMM386) excludes the appropriate portion of memory. Verify that your card is not trying to use the same memory location as another card. You may need to restart the card by calling up the AB object definition dialog box and selecting **OK**. If that does not work try rebooting the computer. Other causes can include memory conflicts, a bad interface card, or a misbehaving driver.

### **KT card CTC test timed out**

#### **KT card CTC test failed with status code xx**

The interface card failed the Counter Timer Circuit test when it was first powered on. This test verifies proper functionality of the card timer and counter modes over all CTC channels. You may need to restart, reseal, or replace the interface card.

### **KT card timed out while loading protocol code**

#### **KT card failed with status code xx while loading protocol**

Lookout was not able to transfer a loader file to the card and subsequently download the card protocol firmware. Try to restart the interface card by calling up the AB object definition dialog box and selecting **OK**. If that does not work try rebooting the computer.

### **KT card is no longer responding**

The Lookout AB object did not receive the interface card heartbeat within the last second. Normally, the card generates a heartbeat any time it receives the DH+ network token. If the alarm does not deactivate after 30 seconds, try to restart the card by calling up the AB object definition

dialog box and selecting **OK**. If that does not work try restarting Lookout or rebooting the computer.

### **KT card memory address conflicts with card *n***

Lookout found another interface card with the same memory address. Be sure that the memory address on each interface card is different and that the corresponding **Memory address** in the Lookout object matches the card address.

### **KT card not present in this computer**

The **Card exists in this computer** check box is deselected (this is the default setting). Select **Object»Modify** to retrieve the PLC definition parameters dialog box and select the **Card exists in this computer** check box and **OK** to initialize the card.

### **KT card RAM test timed out**

#### **KT card RAM test failed with status code *xx***

The interface card failed a memory test when it was first powered on. The memory test writes a pattern to on-board RAM and reads its content to verify the card memory is working. Confirm that the memory address specified in the **Object»Modify** dialog box is correct. You may need to restart, reseat, or replace the card.

### **KT card signature test failed**

The AB object does not recognize the card. Make sure that the interface card is actually installed in the PC and that you indicated the correct memory address in Lookout. You may need to reseat the card, or the card may require repair. Also ensure that you did not identify more **Card Numbers** than actual physical cards.

### **KT card SIO test timed out**

#### **KT card SIO test failed with status code *xx***

The interface card failed the Serial Input Output test when it was first powered on. You may need to restart, reseat, or replace the interface card.

### **KT card send mailbox timed out**

The AB object timed out while waiting for the KT card to signal that it is ready to be given a new message to send. This is most likely due to a communication problem between the computer and the PLC. Confirm that the network cable is properly installed and that the PLC is turned on.

### **NAK response received**

The AB object received a NAK (not acknowledged) response when it polled the device. The device received a command from Lookout but it did not accept the message. The command that the device received may be incomplete or contain irregularities due to poor network performance. If your Serial Port is configured for radio, you may need to adjust the **RTS delay off** setting. Also consider increasing the number of **Retry attempts**.

### **No response — no ACK for our transmission**

Lookout is not getting any response from the device. This could be caused by just about anything. Verify that the **Data rate**, **Parity**, and **Error detection** settings are the same as the settings on the device. Make sure you are using the proper **Serial port** on your computer. Verify that the device interface module and other network equipment is connected and working properly. If you are using a modem, verify that your object **Phone number** and the serial port **Dial-up** settings are correct. This may also be caused by low level noise or reflections on the highway, or marginal circuitry on a card.

### **No response within timeout period**

#### **No response received after receiving ENQ**

The AB object received an acknowledgment of its poll from the device. The device accepted the command from Lookout. However, the device did not appear to send anything else back in response. You may have to increase **Receive timeout** to make sure Lookout allows enough time to receive the message.

### **EOT response received**

The AB object received an EOT (end of transmission) response when it polled the device indicating that the device did not have a message ready to give in response to the Lookout poll request. It is unlikely that you will ever see this error message.

### **Received TSN does not match**

**Response message garbled -- bad CRC or bad BCC**

**Response message garbled -- no DLE EXT**

**Response message garbled -- bad DLE follower**

The AB object is receiving messages from the device. However, the messages may be failing the selected data integrity test. Verify that the object **Error detection** setting is the same as the settings on the device. Another cause may be that the last part of the message is actually getting clipped off before it is completed. You may have to increase the **Receive gap** Serial Port setting to ensure Lookout is receiving the entire message. If your Serial Port is configured for radio this could be caused by an audible

scquelch tail occurring at the end of a radio transmission. You may need to adjust the **RTS delay off** or the **CTS timeout** settings. Also consider increasing the number of **Retry attempts**.

#### **Socket communications error *dd: msg***

The AB object has encountered a problem while attempting to communicate using TCP/IP. The error number *dd* and corresponding error message *msg* give further information. Confirm that the IP address of the PLC has been entered correctly and that the PLC is reachable over the TCP/IP network.

#### **SS card failed**

This message is suffixed with an error message read from the card itself. You may need to contact the vendor of your card for technical support.

#### **SS card failed while performing diagnostics**

Lookout successfully wrote the KT-emulation program to the 5136-SD card, but the program failed to terminate. Try running the `sdinst.exe` program that ships with the 5136-SD card, using the `CHK` option to confirm that the card is working properly.

#### **Unable to access physical memory at segment *0xAAAA***

Lookout was unable to access the memory at the given segment address. The memory may already be in use by the operating system or by another application. Either change the object memory address (which may involve changing switch settings on the card itself) or, if you are using a memory manager, make sure that it is excluding the correct portion of memory.

#### **Unable to open port *0xPPP* for SS card**

Lookout was unable to open the port number specified for the 5136-SD card. Make sure that you have specified the port that is selected by the jumper settings on the card. Make sure that port and the following two ports (for example, 250, 251, and 252) are not in use by any other devices in your computer.

#### **Unexpected data response length**

#### **Unexpected response**

#### **Unhandled error**

You will probably never see one of these alarms. If you do, call National Instruments and ask for technical support.

# AdvantechPCL

The AdvantechPCL object class enables Lookout to communicate with the Advantech PC-MultiLab Card, model PCL-711B. The MultiLab Card installs in your computer and provides one analog output, eight analog inputs, 16 digital inputs and 16 digital outputs.

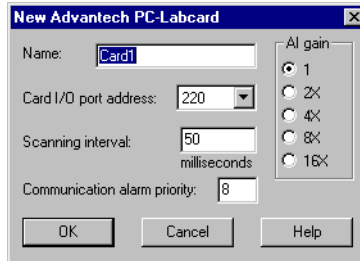

**Figure 3-5.** AdvantechPCL Definition Parameters Dialog Box

**Card I/O port address** indicates the base I/O port address you chose using DIP switch settings on the card. The Advantech card uses 16 consecutive I/O port address locations in your computer. So if you identify base address 220 (hex), it uses addresses 220 to 22F. Valid base addresses range from 000 to 3F0. If your computer does not have an Advantech card installed, be sure to select no card.



**Note** I/O ports identify to the CPU the location of basic system components such as serial ports, video cards, and disk controllers. Check your computer hardware manual and add-on board configurations to be sure you are assigning a unique I/O port address to the Advantech card.

**Scanning interval** is a numeric parameter that determines how often Lookout scans the card for changed values. Valid intervals range from 10 to 1000 milliseconds.

**AI gain** specifies the input amplification gains of all analog input signals (AI0 – AI7). For the highest possible resolution, you should amplify the input signals so that their maximum voltage swing equals their maximum input range. The following table lists recommended settings.

<b>If your maximum voltage range is...</b>	<b>use A1 gain...</b>
±5V	1
±2.5V	2X



If your maximum voltage range is...	use A1 gain...
$\pm 1.25\text{V}$	4X
$\pm 0.625\text{V}$	8X
$\pm 0.3125\text{V}$	16X

**Communication alarm priority** determines the priority level of the alarms generated by the AdvantechPCL object class.

## AdvantechPCL Data Members

The table that follows lists data members supported by the AdvantechPCL object class.

**Table 3-6.** AdvantechPCL Data Members

Data Member	Type	Read	Write	Description
AI0 – AI7	Analog	yes	no	Analog input where AI0 represents A/D 0 (pin 1 on CN1) and AI7 represents A/D 7 (pin 15 on CN1). Each input is a 12-bit integer, ranging from 0 to 4095.
AO0	Analog	no	yes	Analog output where AO0 represents D/A (pin 17 on CN1). This output is a 12-bit integer, ranging from 0 – 4095 (+5V or +10V, depending on jumper JP1).
CommFail	logical	yes	no	Object-generated signal that is on if, for whatever reason, Lookout cannot communicate with the card.
DI0 – DI15	logical	yes	no	Digital input where DI0 represents pin 1 and DI15 represents pin 16 on CN4. Returns False when a monitored signal is open ( $>2.0\text{V}$ ), True when the signal is shorted ( $<0.8\text{V}$ ).
DO0 – DO15	logical	no	yes	Digital output where DO0 represents pin 1 and DO15 represents pin 16 on CN3.
Update	logical	yes	no	Object-generated signal that pulses each time the object scans the device.

# Applicom

Applicom is a set of object classes Lookout uses to communicate with a series of devices and protocols, including the Applicom on-board database (Local mode), April 1000, Klockner-Moeller, Otic Fischer & Porter, Profibus DP, Profibus FMS, Profibus L2, SAIA-SBus, Siemens S7MPI, Siemens H1, Siemens S5 AS511, and Telemecanique.

The following illustration on the left is the dialog box for creating an Applicom Local object. At right is the dialog box for creating an Applicom Telemecanique object. The Telemecanique object has the same parameters as all the other Applicom objects except for Applicom Local, and makes a good representative sample for the group.

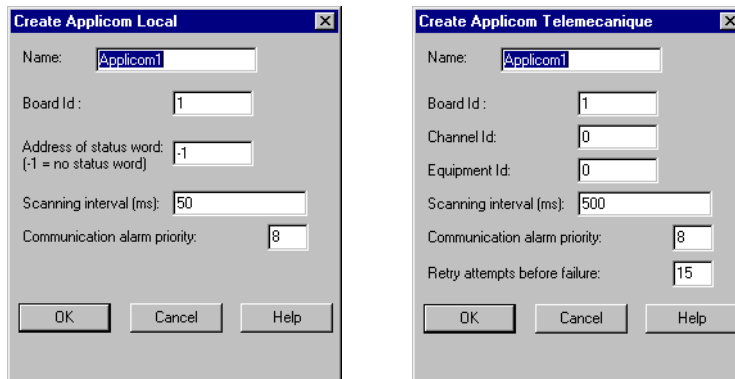

**Figure 3-6.** Applicom Definition Parameters Dialog Boxes

**Board ID** identifies the board you are trying to address.

**Address of status word** is the address of the specific cyclic function of your Applicom board that you want to interact with using this Applicom Local object.

**Channel ID** identifies the Applicom channel your device is communicating on.

**Equipment ID** is the Applicom equipment ID for the device you are connecting to.

**Scanning interval** is the time period between polls. Valid range is 10 - 65535 (expressed in msec).

**Communication alarm priority** determines the priority level of the alarms generated by the object.

**Retry attempts before failure** specifies the consecutive number of times Lookout attempts to establish communications with a device if it is not getting a valid response. After it tries the number of **Retry attempts** specified, the Applicom object generates an alarm and releases the communication port back to the communications service which then moves on to the next device in the polling queue (if any). Refer to Chapter 3, *Serial Port Communication Service*, in the *Lookout Developer's Manual* for more detailed information.

**Table 3-7.** Lookout Applicom Object Classes and the Corresponding Protocols/Devices

Object Class	Device/protocol
Applicom Local	Any device or protocol supported by Applicom cards. See the <a href="#">Special Instructions on Using the Applicom Local Object Class</a> section, for more detailed information on using this object.
Applicom JBUS	Devices using Jbus protocol (mostly those made by April).
April 1000	April 1000 PLC using Ethway or Fipway protocols.
Klockner-Moeller	Klockner-Moeller SUCOS PS32 and PS316 PLC using the Sucoma link.
Otic Fischer & Porter	Otic Fischer & Porter controllers of series 2000, 5000, and 2000 supervisor using the DATALINK protocol.
Profibus DP	Profibus DP with any I/O module or PLC that communicates on a Profibus network using the Decentralized Periphery protocol (includes some Siemens S5 PLCs).
Profibus FMS	Profibus FMS protocol with any master or slave FMS device on a Profibus network (includes most Siemens PLCs).
Profibus L2	Profibus L2 protocol with Siemens S5 PLC using Siemens France messaging system. (The PLC must be running a program also distributed with the Applicom hardware.)
SAIA-SBus	SAIA SBus master protocol.
Siemens S7MPI	Siemens MPI protocol with Siemens S7 PLCs.
Siemens H1	Sinec H1 protocol with various Siemens PLCs.

**Table 3-7.** Lookout Applicom Object Classes and the Corresponding Protocols/Devices (Continued)

Object Class	Device/protocol
Siemens S5 AS511	AS511 (programming port) protocol with Siemens S5 PLCs.
Telemecanique	Uni-Telway, Ethway and Fipway protocols with all Telemecanique PLCs.

## Applicom Data Members

**Table 3-8.** Applicom Local Data Members

Data Member	Type	Read	Write	Description
B0-B31999	logical	yes	yes	Output bits
CommFail	logical	yes	no	Object-generated signal that is ON if Lookout cannot communicate with the device(s)
D0-D31998	numeric	yes	yes	Internal double words
DS0-DS31998	numeric	yes	yes	Signed internal double words
F0-F31998	numeric	yes	yes	Internal floating words
O0-O13999	numeric	yes	yes	Internal bytes
OS0-OS13999	numeric	yes	yes	Signed internal bytes
Update	logical	yes	no	Goes FALSE when a poll starts and TRUE when a poll completes
W0-W31999	numeric	yes	yes	Output words
WS0-WS31999	numeric	yes	yes	Signed output words

**Table 3-9.** Applicom JBUS Data Members

Data Member	Type	Read	Write	Description
B0-B4294967295	logical	yes	yes	Internal bits
BI0-BI4294967295	logical	yes	no	Input bits
BO0-BO4294967295	logical	yes	yes	Output bits

**Table 3-9.** Applicom JBUS Data Members (Continued)

<b>Data Member</b>	<b>Type</b>	<b>Read</b>	<b>Write</b>	<b>Description</b>
CommFail	logical	yes	no	Object-generated signal that is ON if Lookout cannot communicate with the device(s)
D0-D4294967295	numeric	yes	yes	Internal double words
F0-F4294967295	numeric	yes	yes	Internal floating words
O0-O4294967295	numeric	yes	yes	Internal bytes
O0.0-O4294967295.7	logical	yes	yes	Bit in internal bytes
O0.0-O4294967295.7	logical	yes	yes	Bit in internal bytes
OI0-OI4294967295	numeric	yes	no	Input bytes
OIS0-OIS4294967295	numeric	yes	no	Signed input bytes
OO0-OO4294967295	numeric	yes	yes	Output bytes
OOS0-OOS4294967295	numeric	yes	yes	Signed output bytes
OS0-OS4294967295	numeric	yes	yes	Signed internal bytes
Update	logical	yes	no	Goes FALSE when a poll starts and TRUE when a poll completes
W0-W4294967295	numeric	yes	yes	Internal words
W0.0-W4294967295.15	logical	yes	yes	Bits in internal words
WI0-WI4294967295	numeric	yes	no	Input words
WIS0-WIS4294967295	numeric	yes	no	Signed input words
WO0-WO4294967295	numeric	yes	yes	Output words
WOS0-WOS4294967295	numeric	yes	yes	Signed output words
WS0-WS4294967295	numeric	yes	yes	Signed internal words

**Table 3-10.** Applicom April 1000 Data Members

<b>Data Member</b>	<b>Type</b>	<b>Read</b>	<b>Write</b>	<b>Description</b>
CommFail	logical	yes	no	Object-generated signal that is ON if Lookout cannot communicate with the device(s)
FD0-FD409598	numeric	yes	yes	Floating words in the data words
IX00000-IX96931	logical	yes	no	Input bits
MD0-MD409598	numeric	yes	yes	Double words in the data words
MDS0-MDS409598	numeric	yes	yes	Signed double words in the data words
MW0-MW409599	numeric	yes	yes	Data words
MWS0-MWS409599	numeric	yes	yes	Signed data words
MX0-MX16383	logical	yes	yes	Not safeguarded internal bits
QX00000-QX96931	logical	yes	yes	Output bits
RX0-RX8191	logical	yes	yes	Safeguarded internal bits
Update	logical	yes	no	Goes FALSE when a poll starts and TRUE when a poll completes

**Table 3-11.** Applicom Klockner-Moeller Data Members

<b>Data Member</b>	<b>Type</b>	<b>Read</b>	<b>Write</b>	<b>Description</b>
B0-B4294967295	logical	yes	yes	Internal bits
BI0-BI4294967295	logical	yes	no	Input bits
BO0-BO4294967295	logical	yes	yes	Output bits
CommFail	logical	yes	no	Object-generated signal that is ON if Lookout cannot communicate with the device(s)
D0-D4294967295	numeric	yes	yes	Internal double words
DS0-DS4294967295	numeric	yes	yes	Signed internal double words
F0-F4294967295	numeric	yes	yes	Internal floating words
O0-O4294967295	numeric	yes	yes	Internal bytes

**Table 3-11.** Applicom Klockner-Moeller Data Members (Continued)

<b>Data Member</b>	<b>Type</b>	<b>Read</b>	<b>Write</b>	<b>Description</b>
O0.0-O4294967295.7	logical	yes	yes	Bit in internal bytes
OIO-OI4294967295	numeric	yes	no	Input bytes
OIS0-OIS4294967295	numeric	yes	no	Signed input bytes
OO0-OO4294967295	numeric	yes	yes	Output bytes
OOS0-OOS4294967295	numeric	yes	yes	Signed output bytes
OS0-OS4294967295	numeric	yes	yes	Signed internal bytes
Update	logical	yes	no	Goes FALSE when a poll starts and TRUE when a poll completes
W0-W4294967295	numeric	yes	yes	Internal words
W0.0-W4294967295.15	logical	yes	yes	Bits in internal words
WI0-WI4294967295	numeric	yes	no	Input words
WIS0-WIS4294967295	numeric	yes	no	Signed input words
WO0-WO4294967295	numeric	yes	yes	Output words
WOS0-WOS4294967295	numeric	yes	yes	Signed output words
WS0-WS4294967295	numeric	yes	yes	Signed internal words

**Table 3-12.** Applicom Otic Fischer & Porter Data Members

<b>Data Member</b>	<b>Type</b>	<b>Read</b>	<b>Write</b>	<b>Description</b>
B0-B65535	numeric	yes	yes	Bytes
B0.0-B65535.7	logical	yes	yes	Bits in bytes
BS0-BS65535	numeric	yes	yes	Signed Bytes
C0-C65535	numeric	yes	yes	Floating word on three bytes
CommFail	logical	yes	no	Object-generated signal that is ON if Lookout cannot communicate with the device(s)
H0-H65535	numeric	yes	yes	Floating word on five bytes

**Table 3-12.** Applicom Otic Fischer & Porter Data Members (Continued)

<b>Data Member</b>	<b>Type</b>	<b>Read</b>	<b>Write</b>	<b>Description</b>
L0-L65535	logical	yes	yes	Bits
Update	logical	yes	no	Goes FALSE when a poll starts and TRUE when a poll completes

**Table 3-13.** Applicom Profibus DP Data Members

<b>Data Member</b>	<b>Type</b>	<b>Read</b>	<b>Write</b>	<b>Description</b>
B0-B4294967295	logical	yes	yes	Internal bits
BI0-BI4294967295	logical	yes	no	Input bits
BO0-BO4294967295	logical	yes	yes	Output bits
CommFail	logical	yes	no	Object-generated signal that is ON if Lookout cannot communicate with the device(s)
D0-D4294967295	numeric	yes	yes	Internal double words
DS0-DS4294967295	numeric	yes	yes	Signed internal double words
F0-F4294967295	numeric	yes	yes	Internal floating words
O0-O4294967295	numeric	yes	yes	Internal bytes
O0.0-O4294967295.7	logical	yes	yes	Bit in internal bytes
OI0-OI4294967295	numeric	yes	no	Input bytes
OIS0-OIS4294967295	numeric	yes	no	Signed input bytes
OO0-OO4294967295	numeric	yes	yes	Output bytes
OOS0-OOS4294967295	numeric	yes	yes	Signed output bytes
OS0-OS4294967295	numeric	yes	yes	Signed internal bytes
Update	logical	yes	no	Goes FALSE when a poll starts and TRUE when a poll completes
W0-W4294967295	numeric	yes	yes	Internal words
W0.0-W4294967295.15	logical	yes	yes	Bits in internal words
WI0-WI4294967295	numeric	yes	no	Input words



**Table 3-13.** Applicom Profibus DP Data Members (Continued)

<b>Data Member</b>	<b>Type</b>	<b>Read</b>	<b>Write</b>	<b>Description</b>
WIS0-WIS4294967295	numeric	yes	no	Signed input words
WO0-WO4294967295	numeric	yes	yes	Output words
WOS0-WOS4294967295	numeric	yes	yes	Signed output words
WS0-WS4294967295	numeric	yes	yes	Signed internal words

**Table 3-14.** Applicom Profibus FMS Data Members

<b>Data Member</b>	<b>Type</b>	<b>Read</b>	<b>Write</b>	<b>Description</b>
BID0-BID65535	logical	yes	yes	Bits (simple variables)
BID0SUB0-BID65535S UB240	logical	yes	yes	Bits
CommFail	logical	yes	no	Object-generated signal that is ON if Lookout cannot communicate with the device(s)
DID0-DID65535	numeric	yes	yes	Doubles words (simple variables)
DID0SUB0-DID65535S UB60	numeric	yes	yes	Doubles words
DID0SUBS0-DID65535 SUBS60	numeric	yes	yes	Doubles signal word
DIDS0-DIDS65535	numeric	yes	yes	Double signed words
FID0-FID65535	numeric	yes	yes	Floating words (simple variables)
FID0SUB0-FID65535SU B60	numeric	yes	yes	Floating words
OID0-OID65535	numeric	yes	yes	Bytes (simple variables)
OID0SUB0-OID65535S UB240	numeric	yes	yes	Bytes
OID0SUBS0-OID65535 SUBS240	numeric	yes	yes	Signed bytes
OIDS0-OIDS65535	numeric	yes	yes	Signed bytes (simple variables)

**Table 3-14.** Applicom Profibus FMS Data Members (Continued)

<b>Data Member</b>	<b>Type</b>	<b>Read</b>	<b>Write</b>	<b>Description</b>
Update	logical	yes	no	Goes FALSE when a poll starts and TRUE when a poll completes
WID0-WID65535	numeric	yes	yes	Words (simple variables)
WID0SUB0-WID65535S UB120	numeric	yes	yes	Words
WID0SUBS0-WID65535 SUBS120	numeric	yes	yes	Signed words
WIDS0-WIDS65535	numeric	yes	yes	Signed words (simple variables)

**Table 3-15.** Applicom Profibus L2 Data Members

<b>Data Member</b>	<b>Type</b>	<b>Read</b>	<b>Write</b>	<b>Description</b>
CommFail	logical	yes	no	Object-generated signal that is ON if Lookout cannot communicate with the device(s)
DB1D0.0-DB255D255.15	logical	yes	yes	Bits of DB word
DB1DD0-DB255DD254	numeric	yes	yes	Double words in DB
DB1DD0KG- DB255DD254KG	numeric	yes	yes	Floating words in DB
DB1DDS0- DB255DDS254	numeric	yes	yes	Signed double words in DB
DB1DW0-DB255DW255	numeric	yes	yes	Update pulse: words in DB
DB1DWS0-DB255DWS255	numeric	yes	yes	Signed words in DB
DX0D0.0-DX255D255.15	logical	yes	yes	Bits of DX word
DX0DD0-DX255DD254	numeric	yes	yes	Double words in DX
DX0DD0KG- DX255DD254KG	numeric	yes	yes	Floating words in DX
DX0DDS0- DX255DDS254	numeric	yes	yes	Signed double words in DX

**Table 3-15.** Applicom Profibus L2 Data Members (Continued)

<b>Data Member</b>	<b>Type</b>	<b>Read</b>	<b>Write</b>	<b>Description</b>
DX0DW0-DX255DW255	numeric	yes	yes	Update pulse: words in DX
DX0DWS0-DX255DWS255	numeric	yes	yes	Signed words in DX
F0.0-F255.7	logical	yes	yes	Bits in flag bytes
FD0-FD255	numeric	yes	yes	Double words in flag bytes
FD0KG-FD252KG	numeric	yes	yes	Floating words in flag bytes
FDS0-FDS255	numeric	yes	yes	Signed double words in flag bytes
FW0-FW254	numeric	yes	yes	Words in flag bytes
FWS0-FWS254	numeric	yes	yes	Signed words in flag bytes
FY0-FY255	numeric	yes	yes	Flag bytes
FYS0-FYS255	numeric	yes	yes	Signed flag bytes
I0.0-I127.7	logical	yes	no	Input bits
IB0-IB127	numeric	yes	no	Input bytes
IBS0-IBS127	numeric	yes	no	Signed input bytes
IW0-IW126	numeric	yes	no	Input words
IWS0-IWS126	numeric	yes	no	Signed input words
Q0.0-Q127.7	logical	yes	yes	Output bits
QW0-QW126	numeric	yes	yes	Output words
QWS0-QWS126	numeric	yes	yes	Signed output words
QY0-QY127	numeric	yes	yes	Output bytes
QYS0-QYS127	numeric	yes	yes	Signed output bytes
S0.0-S4095.7	logical	yes	yes	Bits in Sflags (internal bytes)
SD0-SD4095	numeric	yes	yes	Floating words in Sflags
SD0KG-SD4092KG	numeric	yes	yes	Floating words in Sflags
SDS0-SDS4095	numeric	yes	yes	Signed double words in Sflags

**Table 3-15.** Applicom Profibus L2 Data Members (Continued)

<b>Data Member</b>	<b>Type</b>	<b>Read</b>	<b>Write</b>	<b>Description</b>
SW0-SW4094	numeric	yes	yes	Words in Sflags (internal bytes)
SWS0-SWS4094	numeric	yes	yes	Signed words in Sflags (internal bytes)
SY0-SY4095	numeric	yes	yes	Sflags (internal bytes)
SYS0-SYS4095	numeric	yes	yes	Signed Sflags (internal bytes)
Update	logical	yes	no	Goes FALSE when a poll starts and TRUE when a poll completes

**Table 3-16.** Applicom Siemens S5 H1 Data Members

<b>Data Member</b>	<b>Type</b>	<b>Read</b>	<b>Write</b>	<b>Description</b>
CommFail	logical	yes	no	Object-generated signal that is on if Lookout cannot communicate with the device(s)
DB1D0.0 - DB255D255.15	logical	yes	yes	Bits of DB word
DB1DD0 - DB255DD254	numeric	yes	yes	Double words in DB
DB1DD0KG - DB255DD254KG	numeric	yes	yes	Floating words in DB
DB1DDS0 - DB255DDS254	numeric	yes	yes	Signed double words in DB
DB1DW0 - DB255DW255	numeric	yes	yes	Update pulse: words in DB
DB1DWS0 - DB255DWS255	numeric	yes	yes	Signed words in DB
DX0D0.0 - DX255D255.15	logical	yes	yes	Bits of DX word
DX0DD0 - DX255DD254	numeric	yes	yes	Double words in DX

**Table 3-16.** Applicom Siemens S5 H1 Data Members (Continued)

<b>Data Member</b>	<b>Type</b>	<b>Read</b>	<b>Write</b>	<b>Description</b>
DX0DD0KG - DX255DD254KG	numeric	yes	yes	Floating words in DX
DX0DDS0 - DX255DDS254	numeric	yes	yes	Signed double words in DX
DX0DW0 - DX255DW255	numeric	yes	yes	Update pulse: words in DX
DX0DWS0 - DX255DWS255	numeric	yes	yes	Signed words in DX
FD0 - FD255	numeric	yes	yes	Double words in flag bytes
FD0KG - FD252KG	numeric	yes	yes	Floating words in flag bytes
FDS0 - FDS255	numeric	yes	yes	Signed double words in flag bytes
FW0 - FW254	numeric	yes	yes	Words in flag bytes
FWS0 - FWS254	numeric	yes	yes	Signed words in flag bytes
FY0 - FY255	numeric	yes	yes	Flag bytes
FYS0 - FYS255	numeric	yes	yes	Signed flag bytes
I0.0 - I127.7	logical	yes	no	Input bits
IB0 - IB127	numeric	yes	no	Input bytes
IBS0 - IBS127	numeric	yes	no	Signed input bytes
IW0 - IW126	numeric	yes	no	Input words
IWS0 - IWS126	numeric	yes	no	Signed input words
Q0.0 - Q127.7	logical	yes	yes	Output bits
QW0 - QW126	numeric	yes	yes	Output words
QWS0 - QWS126	numeric	yes	yes	Signed output words
QY0 - QY127	numeric	yes	yes	Output bytes
QYS0 - QYS127	numeric	yes	yes	Signed output bytes
S0.0 - S4095.7	logical	yes	yes	Bits in Sflags (internal bytes)
SD0 - SD4095	numeric	yes	yes	Floating words in Sflags

**Table 3-16.** Applicom Siemens S5 H1 Data Members (Continued)

<b>Data Member</b>	<b>Type</b>	<b>Read</b>	<b>Write</b>	<b>Description</b>
SD0KG - SD4092KG	numeric	yes	yes	Floating words in Sflags
SDS0 - SDS4095	numeric	yes	yes	Signed double words in Sflags
SW0 - SW4094	numeric	yes	yes	Words in Sflags (internal bytes)
SWS0 - SWS4094	numeric	yes	yes	Signed words in Sflags (internal bytes)
SY0 - SY4095	numeric	yes	yes	Sflags (internal bytes)
SYS0 - SYS4095	numeric	yes	yes	Signed Sflags (internal bytes)
Update	logical	yes	no	False during Polling sequence

**Table 3-17.** Applicom SAIA SBus Data Members

<b>Data Member</b>	<b>Type</b>	<b>Read</b>	<b>Write</b>	<b>Description</b>
CommFail	logical	yes	no	Object-generated signal that is ON if Lookout cannot communicate with the device(s)
DB0Q0-DB7999Q7999	numeric	yes	yes	Floating data block
DB0R0-DB7999R7999	numeric	yes	yes	Binary data block
DB0R0.0-DB7999R7999.31	logical	yes	yes	Bits in binary data block
DB0R0.0-DB7999R7999.31	logical	yes	yes	Bits in binary data block
F0-F8091	logical	yes	yes	Flags
I0-I8091	logical	yes	no	Input
O0-O8091	logical	yes	yes	Output
Q0-Q4095	numeric	yes	yes	Floating registers
R0-R4095	numeric	yes	yes	Binary registers
R0.0-R4095.31	logical	yes	yes	Bits in binary registers
RS0-RS4095	numeric	yes	yes	Signed binary registers
Update	logical	yes	no	Goes FALSE when a poll starts and TRUE when a poll completes

**Table 3-18.** Applicom Siemens S5 AS511 Data Members

<b>Data Member</b>	<b>Type</b>	<b>Read</b>	<b>Write</b>	<b>Description</b>
CommFail	logical	yes	no	Object-generated signal that is ON if Lookout cannot communicate with the device(s)
DB1D0.0-DB255D255.15	logical	yes	yes	Bits of DB word
DB1DD0-DB255DD254	numeric	yes	yes	Double words in DB
DB1DD0KG-DB255DD254KG	numeric	yes	yes	Floating words in DB
DB1DDS0-DB255DDS254	numeric	yes	yes	Signed double words in DB
DB1DW0-DB255DW255	numeric	yes	yes	Update pulse: words in DB
DB1DWS0-DB255DWS255	numeric	yes	yes	Signed words in DB
DX0D0.0-DX255D255.15	logical	yes	yes	Bits of DX word
DX0DD0-DX255DD254	numeric	yes	yes	Double words in DX
DX0DD0KG-DX255DD254KG	numeric	yes	yes	Floating words in DX
DX0DDS0-DX255DDS254	numeric	yes	yes	Signed double words in DX
DX0DW0-DX255DW255	numeric	yes	yes	Update pulse: words in DX
DX0DWS0-DX255DWS255	numeric	yes	yes	Signed words in DX
F0.0-F255.7	logical	yes	yes	Bits in flag bytes
FD0-FD255	numeric	yes	yes	Double words in flag bytes
FD0KG-FD252KG	numeric	yes	yes	Floating words in flag bytes
FDS0-FDS255	numeric	yes	yes	Signed double words in flag bytes
FW0-FW254	numeric	yes	yes	Words in flag bytes
FWS0-FWS254	numeric	yes	yes	Signed words in flag bytes
FY0-FY255	numeric	yes	yes	Flag bytes
FYS0-FYS255	numeric	yes	yes	Signed flag bytes
I0.0-I127.7	logical	yes	no	Input bits
IB0-IB127	numeric	yes	no	Input bytes

**Table 3-18.** Applicom Siemens S5 AS511 Data Members (Continued)

<b>Data Member</b>	<b>Type</b>	<b>Read</b>	<b>Write</b>	<b>Description</b>
IBS0-IBS127	numeric	yes	no	Signed input bytes
IW0-IW126	numeric	yes	no	Input words
IWS0-IWS126	numeric	yes	no	Signed input words
Q0.0-Q127.7	logical	yes	yes	Output bits
QW0-QW126	numeric	yes	yes	Output words
QWS0-QWS126	numeric	yes	yes	Signed output words
QY0-QY127	numeric	yes	yes	Output bytes
QYS0-QYS127	numeric	yes	yes	Signed output bytes
S0.0-S4095.7	logical	yes	yes	Bits in Sflags (internal bytes)
SD0-SD4095	numeric	yes	yes	Floating words in Sflags
SD0KG-SD4092KG	numeric	yes	yes	Floating words in Sflags
SDS0-SDS4095	numeric	yes	yes	Signed double words in Sflags
SW0-SW4094	numeric	yes	yes	Words in Sflags (internal bytes)
SWS0-SWS4094	numeric	yes	yes	Signed words in Sflags (internal bytes)
SY0-SY4095	numeric	yes	yes	Sflags (internal bytes)
SYS0-SYS4095	numeric	yes	yes	Signed Sflags (internal bytes)
Update	logical	yes	no	Goes FALSE when a poll starts and TRUE when a poll completes

**Table 3-19.** Applicom Siemens S7 MPI Data Members

<b>Data Member</b>	<b>Type</b>	<b>Read</b>	<b>Write</b>	<b>Description</b>
A0.0-A65535.7	logical	yes	yes	Output bits
AB0-AB65535	numeric	yes	yes	Output bytes



**Table 3-19.** Applicom Siemens S7 MPI Data Members (Continued)

<b>Data Member</b>	<b>Type</b>	<b>Read</b>	<b>Write</b>	<b>Description</b>
ABS0-ABS65535	numeric	yes	yes	Signed output bytes
AW0-AW65534	numeric	yes	yes	Output words
AWS0-AWS65534	numeric	yes	yes	Signed output words
CommFail	logical	yes	no	Object-generated signal that is ON if Lookout cannot communicate with the device(s)
DB0.DBD0-DB32767. DBD65532	numeric	yes	yes	Double words in DB
DB0.DBD0F-DB32767. DBD65532F	numeric	yes	yes	Floating words in DB
DB0.DBDS0-DB32767. DBDS65532	numeric	yes	yes	Signed double words in DB
DB0.DBW0-DB32767. DBW65534	numeric	yes	yes	Words in DB
DB0.DBWS0-DB32767. DBWS65534	numeric	yes	yes	Signed words in DB
DB0.DBB0-DB32767. DBB65535	numeric	yes	yes	Bytes in DB
DB0.DBBS0-DB32767. DBBS65535	numeric	yes	yes	Signed bytes in DB
DB1.DBX0.0-DB8191. DB65535.7	logical	yes	yes	Bits in DB byte
E0.0-E65535.7	logical	yes	no	Input bits
EB0-EB65535	numeric	yes	no	Input bytes
EBS0-EBS65535	numeric	yes	no	Signed input bytes
EW0-EW65534	numeric	yes	no	Input words
EWS0-EWS65534	numeric	yes	no	Signed input words
M0.0-M65535.7	logical	yes	yes	Bits in flag bytes
MB0-MB65535	numeric	yes	yes	Flag bytes

**Table 3-19.** Applicom Siemens S7 MPI Data Members (Continued)

<b>Data Member</b>	<b>Type</b>	<b>Read</b>	<b>Write</b>	<b>Description</b>
MBS0-MBS65535	numeric	yes	yes	Signed flag bytes
MD0-MD65532	numeric	yes	yes	Double words in flag bytes
MD0F-MD65532F	numeric	yes	yes	Floating words in flag bytes
MDS0-MDS65532	numeric	yes	yes	Signed double words in flag bytes
MW0-MW65534	numeric	yes	yes	Words in flag bytes
MWS0-MWS65534	numeric	yes	yes	Signed words in flag bytes
Update	logical	yes	no	Goes FALSE when a poll starts and TRUE when a poll completes

**Table 3-20.** Applicom Siemens S7 PPI Data Members

<b>Data Member</b>	<b>Type</b>	<b>Read</b>	<b>Write</b>	<b>Description</b>
A0.0-A65535.7	logical	yes	yes	Output bits
AB0-AB65535	numeric	yes	yes	Output bytes
ABS0-ABS65535	numeric	yes	yes	Signed output bytes
AW0-AW65534	numeric	yes	yes	Output words
AWS0-AWS65534	numeric	yes	yes	Signed output words
CommFail	logical	yes	no	Object-generated signal that is ON if Lookout cannot communicate with the device(s)
DB0.DBD0-DB32767. DBD65532	numeric	yes	yes	Double words in DB
DB0.DBD0F-DB32767. DBD65532F	numeric	yes	yes	Floating words in DB
DB0.DBDS0-DB32767. DBDS65532	numeric	yes	yes	Signed double words in DB
DB0.DBW0-DB32767. DBW65534	numeric	yes	yes	Words in DB

**Table 3-20.** Applicom Siemens S7 PPI Data Members (Continued)

<b>Data Member</b>	<b>Type</b>	<b>Read</b>	<b>Write</b>	<b>Description</b>
DB0.DBWS0-DB32767. DBWS65534	numeric	yes	yes	Signed words in DB
DB0DBB0-DB32767. DBB65535	numeric	yes	yes	Bytes in DB
DB0DBBS0-DB32767. DBBS65535	numeric	yes	yes	Signed bytes in DB
DB1.DBX0.0-DB8191. DB65535.7	logical	yes	yes	Bits in DB byte
E0.0-E65535.7	logical	yes	no	Input bits
EB0-EB65535	numeric	yes	no	Input bytes
EBS0-EBS65535	numeric	yes	no	Signed input bytes
EW0-EW65534	numeric	yes	no	Input words
EWS0-EWS65534	numeric	yes	no	Signed input words
M0.0-M65535.7	logical	yes	yes	Bits in flag bytes
MB0-MB65535	numeric	yes	yes	Flag bytes
MBS0-MBS65535	numeric	yes	yes	Signed flag bytes
MD0-MD65532	numeric	yes	yes	Double words in flag bytes
MD0F-MD65532F	numeric	yes	yes	Floating words in flag bytes
MDS0-MDS65532	numeric	yes	yes	Signed double words in flag bytes
MW0-MW65534	numeric	yes	yes	Words in flag bytes
MWS0-MWS65534	numeric	yes	yes	Signed words in flag bytes
Update	logical	yes	no	Goes FALSE when a poll starts and TRUE when a poll completes

**Table 3-21.** Applicom Siemens H1 Data Members

<b>Data Member</b>	<b>Type</b>	<b>Read</b>	<b>Write</b>	<b>Description</b>
C1-C2097152	logical	yes	yes	Bits
CommFail	logical	yes	no	Object-generated signal that is ON if Lookout cannot communicate with the device(s)
DCP1-DCP65536	numeric	yes	yes	Drum count preset
DSC1-DSC65536	numeric	yes	yes	Drum step current
DSP1-DSP65536	numeric	yes	yes	Drum step preset
K1-K2097152	numeric	yes	yes	Constant words
K1.0-K2097152.15	logical	yes	yes	Bits in constant words
KF1-KF2097151	numeric	yes	yes	Floating constant words
KS1-KS2097152	numeric	yes	yes	Signed constant words
STW1-STW65536	numeric	yes	yes	System status words
TCC1-TCC65536	numeric	yes	yes	Timer/counter current
TCP1-TCP65536	numeric	yes	yes	Timer/counter preset
Update	logical	yes	no	Goes FALSE when a poll starts and TRUE when a poll completes
V1-V2097152	numeric	yes	yes	Internal words
V1.0-V2097152.15	logical	yes	yes	Bits in internal words
VD1-VD2097151	numeric	yes	yes	Internal double words
VDS1-VDS2097151	numeric	yes	yes	Signed internal double words
VF1-VF2097151	numeric	yes	yes	Floating words
VS1-VS2097152	numeric	yes	yes	Signed internal words
WSY1-WYS2097152	numeric	yes	yes	Signed output words
WX1-WX2097152	numeric	yes	yes	Input words
WXS1-WXS2097152	numeric	yes	yes	Signed input words
WY1-WY2097152	numeric	yes	yes	Output words

**Table 3-21.** Applicom Siemens H1 Data Members (Continued)

<b>Data Member</b>	<b>Type</b>	<b>Read</b>	<b>Write</b>	<b>Description</b>
X1-X2097152	logical	yes	no	Input bits
Y1-Y2097152	logical	yes	yes	Output bits

**Table 3-22.** Applicom Telemecanique Data Members

<b>Data Member</b>	<b>Type</b>	<b>Read</b>	<b>Write</b>	<b>Description</b>
B0-B4095	logical	yes	yes	Internal bits
CommFail	logical	yes	no	Object-generated signal that is ON if Lookout cannot communicate with the device(s)
DW0-DW32766	numeric	yes	yes	Internal double words
DWS0-DWS32766	numeric	yes	yes	Signed internal double words
FW0-FW32766	numeric	yes	yes	Internal floating words
I00.0-IF7.F	logical	yes	no	Input bits
IW00.0-IWF7.7	numeric	yes	no	Words in input registers
IWS00.0-IWSF7.7	numeric	yes	no	Signed words in input registers
O00.0-OF7.F	logical	yes	yes	Output bits
OW00.0-OWF7.7 Special	numeric	yes	yes	Words in output registers
OWS00.0-OWSF7.7 Special	numeric	yes	yes	Signed words in output registers
Update	logical	yes	no	Goes FALSE when a poll starts and TRUE when a poll completes
W0-W32767	numeric	yes	yes	Internal words
WS0-WS32767	numeric	yes	yes	Signed internal words

## General Information on Using the Applicom drivers for Lookout

The Applicom drivers for Lookout are all contained in `APPLICOM.CBX` (16- or 32-bit) which is designed to work with the Applicom server software distributed with every Applicom card. These drivers assume that you have version 2.9 or later of the Applicom software installed on the same computer under the same operating system as your copy of Lookout. The `APPLICOM.CBX` file presently supports 12 different object classes corresponding to 12 different protocols or object types.

Before you start using Lookout with Applicom, you must follow certain configuration and testing procedures to ensure that Lookout can communicate with your devices. The steps include configuration, loading, testing, and if you choose, cyclic function configuration.

First, however, take special notice of the two different modes for using the Lookout Applicom driver—Image and Local. The distinction between these two modes is crucial to using the Lookout Applicom object classes.

### Applicom Local and Image Modes

You can configure the Applicom server software to constantly poll a remote device and store data in a database onboard your Applicom card. You use *Local* mode to access that data.

In Lookout, you address the data using a generic addressing scheme (as a bit number, or word number, and so on.). The Applicom card takes care of polling the device and writing out new values to registers on the device. If there are any problems in communicating with the device, an error code may be generated and stored in a specified database location. The Lookout driver can then use the data at that location to generate alarms.

In *Image* mode you address data on the remote device according to the addressing scheme commonly used with the particular class of devices. In this mode, Lookout asks for data directly from a remote device and is notified of communication errors when they arise. The Lookout Applicom driver then retries the particular data transfer repeatedly, generating alarms when the data transfer continues to fail.

You use the Applicom Local object class for local mode functionality, and the other device- or protocol-specific object classes for image mode functionality. You can use Applicom Local concurrently with any of the other Applicom classes.

The Image mode classes are the typical way to use the Applicom driver for most applications. However, the Local mode provides a convenient way to achieve two goals: providing access to data from multiple applications (because any application may use the Applicom functions to access the local mode database); and allowing inputs from one device connected to a card to be written to outputs on another device connected to the same card without the interference of the Windows operating system or the client application (for example, Lookout).

## Configuration of the Applicom Server

After you install the Applicom server software, you must first configure it using the `PCCONF` utility provided as part of the Applicom software. Refer to the *Software Installation* section of your Applicom documentation for details on using Applicom software. You use the `PCCONF` utility to set the basic types of devices connected to the Applicom card and the protocols used to connect to them. You also set all the communication parameters with this program.

While configuring your system with `PCCONF`, make note of the **Channel** number and **Equipment** number for the device(s) you are using Lookout to communicate with. You will need these values as parameters when you create Lookout objects in Image mode.

## Loading of the Applicom Server

After you configure the Applicom Server, you must download the appropriate firmware module to the card and then configure it. You do this by running the Applicom program `PCINIT`. The configuration software notifies you at this time if there is any physical problem with the installation of the card.

You must run `PCINIT` every time you restart the computer if you plan to communicate with the Applicom card and connected devices during that session. Because of this, you may consider putting a shortcut to this program in the Startup program group.

At this point, the Applicom server should be ready to communicate with Lookout and with the remote devices connected to the card. Before starting Lookout and attempting to communicate, you should first test the connections using some of the Applicom programs.

## Testing the Applicom Server

The `ReadWait` program in the Applicom server group is a good example of a program that can be used to test the connectivity of the Applicom card with a remote device. You can also use `WriteWait`, `Essai`, and `Essaigb`. Try performing read or write operations using these programs to test whether you can perform basic data transfer operations between the card and the devices. If these tests fail, Lookout will not be able to communicate with the devices either.

If your tests succeed and Lookout fails to communicate with the Applicom devices, it is likely that the problem is in the Lookout object configuration. Because the Applicom programs require you to use the channel and equipment numbers from the `PCConf` program, testing helps you verify that you have the correct numbers.

## Creating the Cyclic Functions

There is only one more step before you start using the Lookout drivers, and it is required only if you are planning to use the Applicom Local object class. In that case, you must first configure the cyclic functions that exchange data between the onboard database of the Applicom card and the remote devices.

You do this by using either the Applicom `CreateCyc` or `PCCyc` utility programs. These programs require that you enter a channel number, an equipment number, and whether the required operation is a read or a write. You also enter the address of the data on the remote device and the requested address of the data in the database. Once you have created and saved the cyclic functions, you can test them using the `GetDB` and `SetDB` programs in the Applicom server.

After you verify that the card can communicate with the remote device, you can start using Lookout. Create a Lookout object of the appropriate class, enter the required parameters, and start communicating with the remote device.



## Special Instructions on Using the Applicom Local Object Class

The Applicom Local object class behaves very differently from the Image mode object classes. To use it, you must have configured cyclic functions on your Applicom card using the Applicom `PCCyc` or `CreateCyc` programs.

After you configure these functions, you can create one or more Applicom Local objects in Lookout to read from or write to the Applicom database directly. The syntax is a generic syntax which does not correspond with the syntax you use with the PLC. The address you specify in Lookout must be the address of the data on the Applicom board, not the address on the remote device.

You can also specify a status word in the `PCCyc` program for each cyclic function you create. You can then specify a single status address in the object creation/modification dialog box for Applicom Local to get Lookout alarms any time the corresponding cyclic function is unable to exchange data successfully.

The Applicom Local object class is compatible with the other object classes so that you can create multiple Applicom object classes of any type and use them all at the same time.

## Applicom Status Messages

### **The requested address is incorrect**

You have requested data for an invalid address. Check the address and try again. For further details check the Applicom documentation for an explanation of error code 2.

### **Incorrect data type**

The type of the data on the device is not compatible with the requested type. This may occur for different reasons in different protocols. For further details check the Applicom documentation for an explanation of error code 3.

### **Irretrievable data**

The data you are trying to access is irretrievable. Please check that the device is connected and has all the appropriate models. For further details check the Applicom documentation for an explanation of error code 4.

### **Response timed out**

The device did not respond to a message within the time-out period. Check that the device is connected. For further details, check the Applicom documentation for an explanation of error code 33.

### **Check word or parity fault**

Check the channel and target equipment configuration and the wiring to the equipment. For further details, check the Applicom documentation for an explanation of error code 34.

### **Data not available in cyclic read**

There was an error in reading from the card. Contact National Instruments technical support if this error occurs.

### **Equipment not configured**

Configure the equipment with PCConf. If you have already done so, check that you are using the correct (logical) equipment ID, as configured in PCConf.

### **Deferred read or write request when deferred request register is full**

There was an error in writing to the card. Contact National Instruments technical support if this error occurs.

### **Deferred request transfer attempt with transdif when request register is empty**

There was an error in writing to the card. Contact National Instruments technical support if this error occurs.

### **Communication software not initialized**

The Applicom board was not initialized using the PCInit software. Close Lookout, run PCInit and try running Lookout again.

### **Board number not configured**

The board number you are attempting to use is not one that has been configured. Please check the configuration using PCConf.

### **No Applicom interface**

There is no Applicom interface present. Check that PCInit executed correctly.

### **Timeout elapsed. Message lost**

A communication problem occurred that may be related to the configuration of the remote equipment or the bus that the equipment is on.

For further details, check the Applicom documentation for an explanation of error code 55.

**Negative acknowledgment (NAK) from equipment**

A message was received by the destination equipment but not processed due to lack of resources. For further details, check the Applicom documentation for an explanation of error code 56.

**Communication refused by the equipment.**

The equipment is not responding to communication requests. This may be caused by a misconfigured device or by a bad connection with the Applicom card. Check the device configuration, check the Applicom configuration and use the Applicom utilities to check that there is communication between the two.

**Bad frame received**

The remote device is not behaving correctly. Check the configuration of the device.

**Errorcode ID: refer to Applicom documentation**

Your application has returned an error specific to your Applicom device. Consult your Applicom documentation for further information.

# Aquatrol

Aquatrol is a protocol driver class Lookout uses to communicate with Aquatrol W1500 controllers.

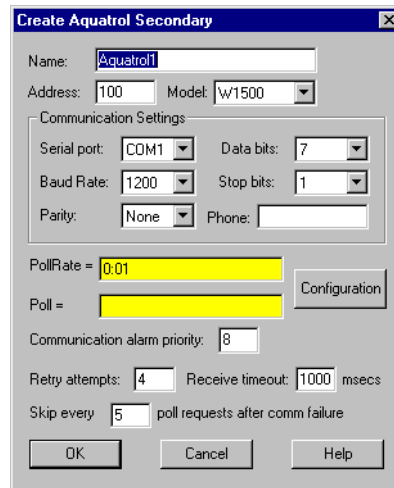

**Figure 3-7.** Aquatrol Definition Parameters Dialog Box

**Address** is the address of the RTU as configured on the device. The address can be in the range of 100 to 999 inclusive.

**Model** is W1500 only at this time.

**Serial port** specifies which port the object uses for communication to the external device. This does not specify the communication type. Communication type is determined by the **Options»Serial Ports...** command.

**Data rate, Parity, Data bits, and Stop bits** reference the settings on the hardware device.

**Phone** specifies the number to be dialed if the serial port setting is configured for dial-up. This number only applies to the individual protocol object.

**PollRate** is a numeric expression that determines how often to poll the device. Lookout converts the numeric value of **PollRate** into a time signal that represents days and fractions of a day. Aquatrol then polls the device at the specified time interval. Normally, this is a time constant such as

0:01 (one second). See the *Numeric Data Members* section in Chapter 2, *How Lookout Works*, of the *Getting Started with Lookout* manual for information on entering time constants.

**Poll** is a logical expression. When this expression changes from false to true, Lookout polls the device. You can use a simple expression like the signal from a pushbutton, or a complex algorithm.

**Communication alarm priority** determines the priority level of object-generated alarms (0 – 10).

**Retry attempts** specifies the consecutive number of times Lookout attempts to establish communications with a device if it is not getting a valid response. After it tries the number of **Retry attempts** specified, the Aquatrol object generates an alarm and releases the communication port back to the communications service which then moves on to the next device in the polling queue (if any).

**Receive timeout** is the time delay Lookout uses in waiting for a response from a device before retrying the request.

The **Skip every...** setting instructs Lookout not to poll a device it has lost communication with on every scheduled poll. Instead, Lookout skips the device in the polling cycle accordingly. Once communications have been reestablished, the device is polled on its regular cycle.

## RTU Configuration Dialog Box

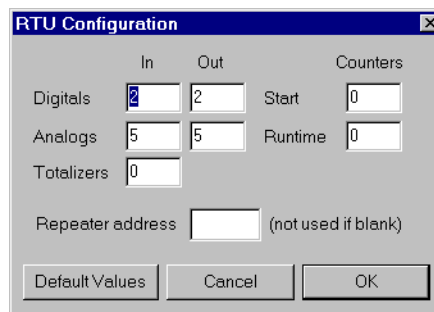

**Figure 3-8.** RTU Configuration Dialog Box

You must configure Lookout to match the configuration in your Aquatrol device.

**Digital (In/Out)** specifies configuration for the number of discrete I/O.

**Analogs (In/Out)** specifies configuration for the number of analog I/O.

**Totalizers** specifies configuration for the number of totalizers.

**Start** specifies configuration for the number of start counters.

**Runtime** specifies configuration for the number of runtime counters.

**Repeater Address** is the final destination address if a repeater is being used.



**Note** The Aquatrol must be configured with all I/O grouped together by kind. Digital inputs must be the first physical inputs on the device, followed by digital outputs. Analog inputs are next, followed by analog outputs. If you do not configure the I/O this way, you can receive invalid data.

## Aquatrol Data Members

All readable and writable members (inputs/outputs), polling instructions, read/write blocking, serial port usage, and so on, are bundled with the object. Therefore, as soon as you create an Aquatrol object you immediately have access to all the object data members (see data member list in Table 3-23).



**Note** Lookout protocol driver objects automatically generate an efficient read/write blocking scheme based on the inputs and outputs being used in your process file. You are not required to build your own I/O blocking table.

**Table 3-23.** Aquatrol Data Members

Data Member	Type	Read	Write	Description
AI1-AI48	numeric	yes	no	Analog Input, 16 bit.
AO1-AO48	numeric	no	yes	Analog Output, 16 bit.
ColdRestart	logical	yes	no	True if the device power has cycled on/off or the reset button has been pushed.
CommFail	logical	yes	no	True if serial communications have failed.

**Table 3-23.** Aquatrol Data Members (Continued)

<b>Data Member</b>	<b>Type</b>	<b>Read</b>	<b>Write</b>	<b>Description</b>
ConfigError	logical	yes	no	True if the configuration of the device does not match the configuration set in the configuration dialog of the Aquatrol device.
DataFail	logical	yes	no	True if the device has had a data failure.
DI1-DI48	logical	yes	no	Discrete Input, 1 bit.
DO1-DO48	logical	no	yes	Discrete Output, 1 bit.
EEPROMerror	logical	yes	no	True if the device has an EEPROM error.
LowBattery	logical	yes	no	True if the device has a low battery.
Poll	logical	no	yes	True initiates a Poll sequence.
PollRate	numeric	no	yes	Time interval of Polling sequence.
PowerFail	logical	yes	no	True if there is no power to the device.
R1-R48	numeric	yes	no	Runtimes, 16 bit.
S1-S48	numeric	yes	no	Starts, 16 bit.
T1-T48	numeric	yes	no	Totalizers, 16 bit.
Update	logical	yes	no	False during Polling sequence.
WarmRestart	logical	yes	no	True if the device has been reset locally.

## Aquatrol Status Messages

### No response within timeout period

No response within timeout period for repeated message. Lookout did not receive the expected response within the **Receive timeout** period. The object sent an inquiry and received an acknowledgment, but the device did not send an expected response to the request. This might happen if the response was interrupted. You may have to increase **Receive timeout**.

### Frame Error (garbled): Invalid destination address

Lookout has received a frame with an invalid return address. Make sure that no duplicate addresses exist on the Aquatrol network.

**Frame Error (garbled): Invalid source address**

Lookout has received a frame from a device that you are not actively polling. Make sure that there is only one outstanding master request at a time.

**Frame Error (garbled): Invalid message length for configuration**

Lookout has received a frame whose length conflicts with the length expected based on the configuration settings in the Aquatrol device configuration dialog box.

**Frame Error (garbled): Invalid CRC**

Lookout has received a frame with an invalid CRC (cyclic redundancy check). Check for signal noise on Aquatrol network.

**Invalid discrete address #: Check configuration settings**

**Invalid analog address #: Check configuration settings**

**Invalid runtime address #: Check configuration settings**

**Invalid start address #: Check configuration settings**

**Invalid totalizer address #: Check configuration settings**

All these errors mean that a I/O point being either read or written is out of range with respect to the configuration set in the Aquatrol device configuration dialog box.



# ASCII

ASCII is a protocol driver class Lookout uses to communicate with any serial device that accepts ASCII characters. This object is only available with 32-bit versions of Lookout.

An ASCII object contains no predefined data points. When you create an ASCII object, you must define your data request strings as well as the template Lookout uses to parse the response frame.



**Figure 3-9.** ASCII Definition Parameters Dialog Box

**Serial port** specifies which COM port the object uses for communicating to the external device. This does not specify the communication type. Communication type is determined by the **Options»Serial Ports...** command.

**Baud rate** indicates the rate that Lookout uses to communicate with the hardware device.

**Data bits** indicates the number of data bits that Lookout uses to communicate with the hardware. This setting should match the selection made on the physical device.

**Stop bits** indicates the number of stop bits that Lookout uses to communicate with the hardware device. This setting should match the selection made on the physical device.

**Parity** indicates the parity that Lookout uses to communicate with the hardware device. This setting should match the selection made on the physical device.

**Phone number** specifies the number to be dialed if the selected serial port is configured for dial-up. This number only applies to the individual protocol object.

**Monitor Serial Port** specifies whether you can receive unsolicited frames.

**Communication alarm priority** determines the priority level of alarms generated by the ASCII object. Such alarms are typically related to communications with the physical device.

**Retry attempts** specifies the number of times Lookout attempts to establish communications with a device if it is not getting a valid response. After it tries the number of **Retry attempts** specified, the ASCII object generates an alarm and releases the communication port back to the communications service which then moves on to the next device in the polling queue (if any). Refer to Chapter 3, *Serial Communications*, in the *Lookout Developer's Manual* for more information.

**Receive timeout** is the amount of time Lookout waits for a response from a device before retrying the request.

The **Skip every N poll requests after comm failure** setting instructs Lookout not to poll a device it has lost communication with on every scheduled poll. Instead, Lookout polls the device only once in the specified number of poll cycles. Once communication has been reestablished, the device is polled on its regular cycle.

## ASCII Data Members

**Table 3-24.** ASCII Data Members

Data Member	Type	Read	Write	Description
CommFail	logical	yes	no	Object-generated signal that is on if Lookout cannot communicate with the device(s).
OffHook	logical	no	yes	Keeps the driver from releasing the serial port.
Request	text	yes	no	Exact request frame sent.

**Table 3-24.** ASCII Data Members (Continued)

<b>Data Member</b>	<b>Type</b>	<b>Read</b>	<b>Write</b>	<b>Description</b>
RequestFormat	text	no	yes	Format used to create request frame.
Response	text	yes	no	Exact response frame received.
ResponseFormat	text	no	yes	Format used to parse response frame.
RQSum:1:1 - RQSum255:255	numeric	yes	no	Request byte sum
RQV1, RQV512	numeric	no	yes	Variable list used to populate request frame with numeric values.
RQV1.logical, RQV512.logical	logical	no	yes	Variable list used to populate request frame with logical values.
RQV1.txt, RQV512.txt	text	no	yes	Variable list used to populate request frame with text values.
RSFilter	text	no	yes	All characters in this string will be filtered out of the incoming response before processing.
RSSum1:1 - RSSum255:255	numeric	yes	no	Response byte sum
RSV1, RSV512	numeric	yes	no	Variable list used to store values retrieved from response frame.
RSV1.logical, RSV512.logical	logical	yes	no	Variable list used to store values retrieved from response frame.
RSV1.txt, RSV512.txt	text	yes	no	Variable list used to store values retrieved from response frame.
Send	logical	no	yes	Sends request frame.
Update	logical	yes	no	Object-generated signal that pulses low each time it polls the device.
RSVn, RSVn.txt and RSVn.logical all represent the same value in different forms RQVn, RQVn.txt and RQVn.logical all represent the same value in different forms				

## Request and Response Format Strings

The request and response format strings consist of static characters and markers that control how the request and response frames respectively are formatted or decoded. The request format string is used to *create* the request frame, which is sent to the device, while the response format string is used to *decode* the response frame, which comes from the device.

Static characters in the format strings are reproduced exactly in the request or response frame. Markers specify the location within the frame and type of data which should be found there, such as five characters read as an unsigned integer, for example. The ASCII object constructs a request frame by processing the sequence of static characters and markers in the request format string, and including data from RQV data members.

The response format string decodes a response frame using an analogous process, storing the results in RSV data members.

To construct a request frame, the ASCII object parses the request format string character by character. Static characters are copied directly to the request frame. When a marker is encountered the ASCII object reads a value from the appropriate RQV variable and places it into the request frame.

There are 512 RQV and RSV values provided for in the ASCII object data member collection. The first marker in a format string uses the value from RQV1 (or RQV1.txt or RQV1.logical), the next marker uses the value RQV2, and so on. Values taken from Response strings are stored in RSV data members in the same way.

Keep in mind that writing into RQV1 changes the value both for RQV1.txt and RQV1.logical. Their only difference is the format in which they are represented. The same principle applies to the RSV data members.



**Note** There is no precedence to the order in which multiple objects connected to the same variable number initialize upon opening the process file. Consider, for example, the case in which a Pot object is connected to RQV1 while a TextEntry object is connected to RQV1.txt. You should take care to initialize such variables to the proper value after opening a process file.

To decode a response frame, the ASCII object compares the response frame to the response format string character by character. The static characters in the response frame must match those in the response format string or the decoding process terminates. Static characters are, in effect, discarded

by the ASCII object as they are matched between the response format string and the response frame.

When the ASCII object encounters a marker, it places the data indicated by the marker into the appropriate RSV data member.

The conversion of a portion of the response frame to a data type specified by a marker in the response format string must be valid, or the process will terminate.

If nothing halts the process, decoding terminates when the end of the response frame string is reached.

There are examples of both request frames and response frames at the end of this section, but for the examples to make sense, you must first understand the ASCII object markers.

## ASCII Object Markers

The general format for a marker is:

$$\%[\text{width}][\text{type}]$$

Each field in the marker format is a single character or a number signifying a particular format option.

The % sign denotes the beginning of the marker. For example, to specify that a percent-sign character is a static character part of the frame, use %%.

**Width** is a positive decimal integer specifying the number of characters that particular value occupies in the frame. By default ASCII pads the value with blank spaces if the value takes up fewer characters than the value specified by width. Including a 0 before the width value forces the ASCII object to pad with zeroes instead of blank spaces.

**Type** determines whether the field is interpreted as a character, a string, or a number.

**Table 3-25.** Data Types Allowed by ASCII

Character	Data Type
c	Character
d	Decimal integer
O, o	Octal

**Table 3-25.** Data Types Allowed by ASCII (Continued)

x, X	Hexadecimal integer
u	Unsigned decimal integer
e, f	Floating-point
s	String
b*	Byte (binary)
<p>*For the %b data type:</p> <ul style="list-style-type: none"> <li>– Number of bytes can be specified, for example %3b, %2b.</li> <li>– Response format can read as either signed or unsigned, for example %^b and %3^b are signed and %b is unsigned.</li> <li>– Endian order can be specified, for example %3~b is big endian and %3b is little endian. %5~^b and %2^~b forms are also valid.</li> </ul>	

The simplest format specification contains only the percent sign and a type character (for example, %s). That would place the value in the response frame in the RSV1.txt data member.

<b>Request Format String</b>	<b>RQV1</b>	<b>Request Frame</b>
>%5d	34	> 34
>%05d	34	>00034

The request format string also has a precision value in the form **%[width].[precision][type]**. This specifies the number of digits to the right of the decimal point, if any, in the request frame. If you use a float (%f) and do not specify a precision value, the ASCII object assumes a default of 6.

Characters are converted and stored in RSV data members from response frames in the order they are encountered in the response format. However, fewer than **[width]** characters may be read if a white-space character (space, tab, or newline) or a character that cannot be converted according to the given format occurs before **[width]** is reached.

Values needed for request frames come from the RQV data members, and are also used in the order in which they occur in the request format.

To read strings not delimited by space characters, or that contain spaces, you can substitute a set of characters in brackets ( [ ] ) s (string) type character. The corresponding input field is read up to the first character that does not appear in the bracketed character set. Using a caret (^) as the first character in the set reverses this effect: the ASCII object reads input field up to the first character that does appear in the rest of the character set.

<b>Response Format String</b>	<b>RSV1.txt</b>	<b>Response Frame</b>
<code>\$\$[A - Z,a - z, ]\$</code>	Natl Inst	<code>\$Natl Inst\$</code>
<code>&gt;[^,s]</code>	days	<code>&gt;day</code>

Notice that  `%[a - z]` and  `%[z - a]` are interpreted as equivalent to  `%[abcde...z]`, and that the character set is case sensitive. Valid control characters accepted include the list in the following table.

<b>Control Character</b>	<b>ASCII Code</b>	<b>Description</b>
<code>\a</code> or <code>\A</code>	07 (0x0007)	Alert (Bell)
<code>\b</code> or <code>\B</code>	08 (0x0008)	Backspace
<code>\t</code> or <code>\T</code>	09 (0x0009)	Horizontal Tab
<code>\n</code> or <code>\N</code>	10 (0x000A)	New Line
<code>\v</code> or <code>\V</code>	11 (0x000B)	Vertical Tab
<code>\f</code> or <code>\F</code>	12 (0x000C)	Formfeed
<code>\r</code> or <code>\R</code>	13 (0x000D)	Carriage Return
<code>\\</code>	92 (0x005C)	<code>\</code>
<code>\'</code>	39 (0x0027)	<code>'</code>
<code>\"</code>	34 (0x0023)	<code>"</code>
<code>\?</code>	63 (0x003F)	<code>?</code>

Any ASCII character can be specified in the format string using `\xbb` or `\nnn` masks. `\xbb` is a hexadecimal byte with each `b` representing a valid hex character in the range (0...9, a...F), for example `\xff` or `\x1a`.

`\nnn` is an octal byte with each `n` being a valid octal character in the range 0 to 7, for example `\123` or `\347`. This value may not exceed 255 as it is meant to represent a single byte of data. These two features can be used to create and compare static characters. These can also be specified in the regular expression, for example `%[\xff, \123, \a, \b]` is a valid frame.



**Note** The brackets only work in response format strings. They have no effect in the request format string.

The ASCII object scans each field in the response frame character by character. It may stop reading a particular field before it reaches a character for a variety of reasons:

- The specified width has been reached.
- The next character cannot be converted as specified.
- The next character conflicts with a character in the response format string that it is supposed to match.
- The next character fails to appear in a given character set.

No matter what the reason, when the ASCII object stops reading a field, the next field is considered to begin at the first unread character. The conflicting character, if there is one, is considered unread and is the first character of the next field.

## Entering ASCII Object Format String

For a static connection to one of the format data members, enter your format string in the yellow field box in the Edit Connections dialog box. Remember to begin and end the format strings with quotation marks so that Lookout accepts the string input.

You can also connect any valid text data member, such as a text entry object, to the format data members.



## Request Frame Construction Examples

Request Format String	RQV	Request Frame
<01%4u%s	RQV1=1234 RQV2.txt=Steph	<011234Steph
<01%04u%s	RQV1=34 RQV2.txt=Steph	<010034Steph
<01% 4u%s	RQV1=34 RQV2.txt=Steph	<01 34Steph

A zero in front of the four pads with zeroes; a space pads with spaces.

## Response Format Examples

Response Frame	Response Format String	RSV
*(16.38:	*(%52f:	RSV1=16.38



**Note** The decimal point counts as a character when decoding floats (%f). Also, decimal points denoting precision are not allowed when decoding a float in the response frame.

Response Frame	Response Format String	RSV
>>Test Text<<	>>%s<<	RSV1.txt=Test

The space between the words terminates the conversion. See the preceding bracketed character example in order to span a space or other special characters.

Response Frame	Response Format String	RSV
>>Test Text<<	>>%s%s<<	RSV1.txt=Test RSV2.txt=Text
>>DogCat<<	>>%3s%3s<<	RSV1.txt=Dog RSV2.txt=Cat

The response format uses a space as a delimiter.

## Using Sum Data Members

The ASCII object includes summing data members you can use to calculate checksum characters. This can be a checksum you want to write into an outgoing request frame or a checksum you want to verify in an incoming response frame.

For example, if you want to calculate a checksum for the request A00B, you would use an RQSum (request sum) data member. In the case of A00B, you would use RQSum1 : 4, which would give you a sum of the ASCII byte values of characters 1 through 4. Once you have this sum, you can manipulate it mathematically any way necessary for the checksum value you need. You can then insert this value at the end of your frame as a byte (%b) or a series of bytes.

The same technique works in reverse for RSSum (response sum) data members.

For example, consider the response Z00A@. You know that you are expecting 4 bytes plus a checksum. Assuming that this checksum calculation involves the first four characters, use RSSum1 : 4 to get the byte sum of characters 1 through 4. After performing the appropriate mathematical manipulation, you can compare this value with the actual byte read from the frame, and determine when there is a checksum failure.



**Note** There are many different methods for calculating checksums, and these data members cannot support all of them. Before attempting to use them for checksum calculation, make sure your checksum can be calculated from a simple byte sum of characters in the frame.

## ASCII Error Messages

### **No response from device within timeout period**

Lookout received no response from the device within the **Receive timeout** period. The ASCII object was able to establish a socket, but when it sent a message to the device, the device did not respond—as if it were not there. You may have to significantly increase **Receive timeout** (and **Poll Rate**) to ensure Lookout is allowing enough time to receive the expected response. Also, verify your cable connections, power, configuration settings, and IP settings.

### **Not enough data to send a valid frame**

This means that the ASCII object has not received enough data to fill in all the variables in the Request Format frame. This could mean that you do not have connections made to all of the RQVs that the ASCII object is expecting.

### **Frame Error (garbled)**

ASCII got a response frame, but static characters in the response did not match up to the response format string.

### **Data type or length does not match format string**

ASCII got a response frame, but certain characters in the response were not in the format stated by the markers in the response format string.

### **Illegal control character**

The request frame had a % modifier followed by an invalid control code.

**Related Objects** [IPASCII](#)

# Cutler-Hammer

Cutler-Hammer is a protocol driver class Lookout uses to communicate with Cutler-Hammer devices using serial communications.

It supports reading and writing of all predefined data points allowed by the particular Cutler-Hammer model. When you create a Cutler-Hammer object, you have immediate access to all the object data members. See the [Cutler-Hammer Data Member Set](#) table for more information on data members for this object.

**Figure 3-10.** Cutler-Hammer Definition Parameters Dialog Box

**Address** specifies which Cutler-Hammer device you are communicating with using this object. This number is between 0 and 191, and is set on the device. (An address number of 255 broadcasts to all devices connected to the network.)

**PLC Model** specifies what model of Cutler-Hammer device you are using. The only model supported now is the Cutler-Hammer D50.

**Serial port** specifies which comm port the object uses for communicating to the external device. This does not specify the communication type. Communication type is determined by the **Options»Serial Ports** command.



**Note** For Lookout to communicate correctly with the Cutler-Hammer D50, you must configure your COM port as `radio` using the **Options»Serial Ports** command.

**Data rate** indicates the baud rate that Lookout uses to communicate with the hardware device. This setting should match the selection made on the physical device.

**Data bits** indicates the number of data bits that Lookout uses to communicate with the hardware device. This setting should match the selection made on the physical device.

**Stop bits** indicates the number of stop bits that Lookout uses to communicate with the hardware device. This setting should match the selection made on the physical device.

**Parity** indicates the parity that Lookout uses to communicate with the hardware device. This setting should match the selection made on the physical device.

**Phone number** specifies the number to be dialed if the selected serial port is configured for dial-up. This number only applies to the individual protocol object.

**PollRate** is a numeric expression that determines how often to poll the device. Lookout converts the numeric value of **PollRate** into a time signal that represents days and fractions of a day. The object then polls the device at the specified time interval. Normally, this is a time constant such as 0:01 (one second). See the *Numeric Data Members* section in Chapter 2, *How Lookout Works*, of the *Getting Started with Lookout* manual for information on entering time constants.

**Poll** is a logical expression. When this expression changes from false to true, Lookout polls the device. You can use a simple expression like the signal from a pushbutton, or a complex algorithm.

**Communication alarm priority** determines the priority level of alarms generated by the Cutler-Hammer object. Such alarms are typically related to communications with the physical device.

**Retry attempts** specifies the consecutive number of times Lookout attempts to establish communications with a device if it is not getting a valid response. After it tries the number of **Retry attempts** specified, the Cutler-Hammer object generates an alarm and releases the comm port. See Chapter 3, *Serial Port Communication Service*, in the *Lookout Developer's Manual* for more information.

**Receive timeout** is the time delay Lookout uses in waiting for a response from a device before retrying the request.

The **Skip every N poll requests after comm failure** setting instructs Lookout to not poll a device it has lost communication with on every scheduled poll. Instead, Lookout skips the device in the polling cycle accordingly. Once communications have been reestablished, the device is polled on its regular cycle.

## Cutler-Hammer Data Members

As with all Lookout drivers, you can access I/O points and other data through data members. The following is a table of data members currently supported by the Cutler-Hammer object class.

**Table 3-26.** Cutler-Hammer Data Member Set

Data Member	Type	Read	Write	Description
CommFail	logical	yes	no	Goes high if Lookout cannot communicate with the device
K0000 - K0015	numeric	yes	yes	Keep relay
K00000.logical - K01515.logical	logical	yes	yes	Keep relay
M0000 - M0031	numeric	yes	yes	Internal relay
M00000.logical - M03115.logical	logical	yes	yes	Internal relay
Poll	logical	no	yes	When transitioned from low to high, Lookout begins a poll cycle on the device
PollRate	numeric	no	yes	Specifies the frequency at which Lookout polls the device
R00000.logical - R02915.logical	logical	yes	yes	External inputs and outputs, and special function registers

**Table 3-26.** Cutler-Hammer Data Member Set (Continued)

<b>Data Member</b>	<b>Type</b>	<b>Read</b>	<b>Write</b>	<b>Description</b>
Update	logical	yes	no	Goes high when Lookout begins a poll cycle on the device
W0000 - W2815	numeric	yes	yes	Timers, counters, and word registers
For a more complete definition of the function of these data members, see Cutler-Hammer documentation. Not all of these data members are valid for every Cutler-Hammer device. See Cutler-Hammer documentation to see which data members are valid for your particular model number.				

## Cutler-Hammer Status Messages

### No response within timeout period

Lookout received no response from a device within the **Receive timeout** period. The Cutler-Hammer object is able to use the comm port, but when it polls the device, it does not respond—as if it is not even there. If you have daisy-chained several devices, you may have introduced an inherent delay. You may have to significantly increase **Receive timeout** (and **Poll Rate**) to ensure Lookout is allowing enough time to receive the expected response. This increase has nothing to do with the processing capabilities of Lookout. Rather it is based solely on **Data rate** and the number of devices on the chain. Also, verify your baud rate settings, cable connections, power, configuration settings, comm port settings, and polling addresses.

### Invalid query acknowledge frame

This means that the query acknowledge frame sent from the PLC in response to the command sent by Lookout out was invalid.

### Invalid PLC address in response frame

This means that the address within the response frame from the PLC does not match exactly the address in the command sent out by Lookout. You may possibly be requesting an address that is outside the valid range from Cutler-Hammer devices.

### Invalid CRC in response

This means the checksum (CRC in this case) failed in a frame received by Lookout. Check cabling or for two or more devices with the same address.

### Garbled or invalid frame

Frame received without format characters in their proper positions. Check the **Receive gap** setting.

**Invalid response frame**

This means that the response frame from the PLC did not have the expected number of bytes in it.

**Invalid function code in response frame**

This means that the function code within the response frame from the PLC does not match the function code in the command sent out by Lookout.

**Wrong query, length, or designation**

This is an error returned as an error code frame from the Cutler-Hammer device. This means that the device could not successfully interpret the query you just sent it.

**Designated range exceeded**

This is an error returned as an error code frame from the Cutler-Hammer device. It means you have requested an address beyond the valid range of addresses.

**Command too long in length**

This is an error returned as an error code frame from the Cutler-Hammer device. This means that the frame just sent has exceeded the maximum amount information that can be transported in a single frame (256 bytes).

**Abnormal communications command**

This is an error returned as an error code frame from the Cutler-Hammer device.

**Cutler-Hammer models supported:**

D50



# DeltaTau

---

DeltaTau is a protocol driver object class Lookout uses to communicate with Delta Tau Data Systems PMAC Motion Controllers. Create a DeltaTau object for each card installed in the computer.

This object class communicates with Delta Tau PMAC cards through dual-ported memory, so be sure that your PMAC hardware includes the dual-ported RAM option.

The following figure shows a Delta Tau card configured to use PC memory beginning at address D000.

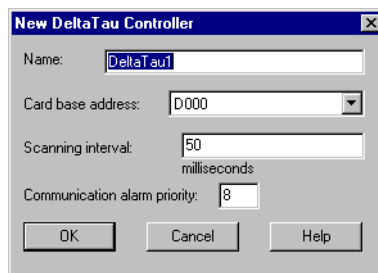

**Card base address** specifies the beginning memory location of the dual ported RAM address. It should match card settings.

**Scanning Interval** identifies the frequency that the DeltaTau object in Lookout polls the PMAC Motion Controller. Intervals can range from 10 ms to 1,000 ms.

**Communication alarm priority** specifies the priority level of alarms generated by the object.

## DeltaTau Data members

Like other protocol driver objects, DeltaTau objects contain a great deal of data. All readable and writable members (inputs/outputs), polling instructions, and so on, are bundled with the object. Therefore, as soon as you create a DeltaTau object you immediately have access to all the object data members. The following table lists data members for the DeltaTau object.

**Table 3-27.** DeltaTau Data Members

<b>Data Member</b>	<b>Type</b>	<b>Read</b>	<b>Write</b>	<b>Description</b>
DS0 – DS8190	numeric	yes	yes	Signed 32-bit word ranging from –2,147,483,648 to 2,147,483,647
DW0 – DW8190	numeric	yes	yes	32-Bit double-precision word ranging from 0 to 4,294,967,295
F0 – F8188	numeric	yes	yes	32-bit IEEE floating point word
S0 – S8190	numeric	yes	yes	Signed 16-bit word ranging from –32,768 to 32,767
Update	logical	yes	no	Driver-generated signal that pulses each time Lookout scans the PMAC Motion Controller card
W0 – W8190	numeric	yes	yes	16-Bit word ranging from 0 to 65,535
W0.0 – W8190.15	logical	yes	yes	1 Bit in a 16-Bit word

# DL205, DL405

DL205 and DL405 are protocol driver object classes Lookout uses to communicate with Koyo 205 and 405 PLCs, and other devices that use the CCM protocol.

Koyo sells the 205 and 405 models under private brand labels. PLCDirect offers the units as the DirectLOGIC 205 and 405 PLCs, and Siemens offers the 405 unit as the TI405 series.

The DL205 and DL405 object classes support the Koyos native protocol, CCM, which is also called DirectNET by PLCDirect and HostLink by Siemens. This documentation refers to this protocol as CCM.

The DL205 and DL405 object classes support both point-to-point and multidrop configurations. You can connect Lookout to a PLC programming port, built-in DirectNET/HostLink port, or to the PLC DCM (data communication module). These PLC communication ports use two different versions of the CCM protocol: K-sequence and N-sequence. Lookout supports both.

The screenshot shows the 'Create DL205' dialog box with the following settings:

- Name: DL1
- PLC Address: (empty)
- Model: DL240
- Protocol: Lower port (n)
- Serial Settings:
  - Serial port: COM1
  - Parity:  Odd
  - Data bits:  8
  - Stop bits:  1
  - Data rate:  19200
- Phone number: (empty)
- PollRate = 0.01
- Poll = (empty)
- Communication alarm priority: 8
- Retry attempts: 4
- Receive timeout: 500 msec
- Skip every 5 poll requests after comm failure

**Figure 3-11.** DL205 Parameters Configured for one PLC in a Multidropped Configuration

**Protocol** identifies the CCM port you use to communicate with the device. If you are planning to connect Lookout to a single PLC in a point-to-point configuration, choose the `UPPER PORT (k)` **Protocol** and use the PLC programming port. It supports K-sequence CCM. With this version of the CCM protocol you can write directly to logical outputs.

If you are planning to network multiple PLCs in a multidrop configuration where Lookout is the host computer, you must use the built-in PLC DirectNET/HostLink port, or its DCM. Choose the `LOWER PORT (n)` or `DCM (n) Protocol` as appropriate. These ports support N-sequence CCM. The N-sequence CCM protocol does not permit writes directly to logical data members.



**Note** Although you can connect logical signals to data members such as Y0 in Lookout, any time you attempt to write to such a data member using the N-sequence CCM protocol, the write request is ignored. (This is due to the limitations of N-sequence CCM protocol.) If you have to write out a logical value using N-sequence, consider parsing the corresponding VU address into a binary number and setting the bit you want to use by writing a corresponding decimal integer. If you write a zero or 65535 to the corresponding VU-memory location, you will write all zeros or ones to every bit in the register.

**PLC Address** is a slave address and refers to the address setting as set on the physical device. If you are connecting to the PLC programming port, set **PLC Address** to 1. If multiple devices share a common line, enter the unique addresses of the device (1 to 255).

Use **Model** to choose the PLC model you want to use. If you are using a model not listed, select a model whose data set most closely fits the model you are using.

**Serial port** specifies which COM port on your computer that the object uses for communicating to the PLC. This does not specify the communication type. Communication type is determined by the **Options»Serial Ports...** command.

**Data rate, Parity, Data bits, and Stop bits** should match the PLC settings.

**Phone number** specifies the number to be dialed if the selected serial port is configured for dial-up. This number only applies to the individual protocol object.

**PollRate** is a numeric expression that determines how often to poll the device. The object then polls the device at the specified time interval. Normally, this is a simple time constant such as 0:01 (one second).

See *Numeric Data Members* in Chapter 2, *How Lookout Works*, of the *Getting Started with Lookout* manual for information on entering time constants.

**Poll** is a logical expression. When this expression changes from false to true, Lookout polls the device. You can use a simple expression like the signal from a pushbutton, or a complex algorithm.

**Communication alarm priority** determines the priority level of alarms generated by the object. Such alarms are typically related to communications with the physical device.

**Retry attempts** specifies the consecutive number of times Lookout attempts to establish communications with a device it does not get a valid response from. After the object retries communications the specified number of times, it generates a communication alarm and Lookout moves on to the next device in the polling queue (if any). Refer to Chapter 3, *Serial Port Communication Service*, in the *Lookout Developer's Manual* for more information.

**Receive timeout** is the time delay Lookout uses in waiting for a response from a device before retrying the request.

The **Skip every...** setting instructs Lookout to not poll a device it has lost communication with on every scheduled poll. Instead, Lookout skips the device in the polling cycle accordingly. Once communications have been reestablished, the device is polled on its regular cycle.

## DL205 and DL405 Data Members

Protocol driver objects contain a great deal of data. V-memory addresses, registers, inputs and outputs are all bundled with the object. Therefore, as soon as you create a DL205 object you have immediate access to the entire data member set of the object (see data member list in Table 3-28).

As with all Lookout drivers, you can access I/O points and other data through data members. The DL205 and DL405 object classes automatically generate an efficient read/write blocking scheme based on the inputs and outputs you are using in your process file. So, you do not have to build your own I/O blocking table. When Lookout polls a device, it optimizes frame exchange according to the data length required and overhead needed. The maximum data frame size that these drivers request is 256 data bytes. The drivers use LRC and parity error checking to validate data.

The following is a table of data members currently supported by the DL205 and DL405 object class.

**Table 3-28.** DL205 and DL405 Data Members

<b>Data Member</b>	<b>Type</b>	<b>Read</b>	<b>Write</b>	<b>Description</b>
C0 – C3777	logical	yes	yes	Control Relays—addressed in octal and mapped to V40600 – V40700.
CommFail	logical	yes	no	Object-generated signal that is on if, for whatever reason, Lookout cannot communicate with the device.
CT0 – CT377	logical	yes	yes	Counter status bits—addressed in octal and mapped to V41140 – V41147.
OffHook	logical	no	yes	When TRUE, this flag instructs the DL object to retain exclusive use of its assigned communication port.
Poll	logical	no	yes	When this value transitions from FALSE to TRUE, Lookout polls the device.
PollRate	numeric	no	yes	Lookout expression that determines the device polling frequency.
S0 – S1777	logical	yes	yes	Stages—addressed in octal and mapped to V41000 – V41037.
SPA0 – SPA177	logical	yes	yes	Lower special relays—addressed in octal.
SPB320 – SPB717	logical	yes	yes	Upper special relays—addressed in octal.
T0 – T377	logical	yes	yes	Timer status bits—addressed in octal and mapped to V41100 – V41107.
Update	logical	yes	no	Object-generated signal that pulses low each time it polls the device.
V0 – V41230	numeric	yes	yes	Signed V-memory register containing 16-bit integer ranging from –32768 to 32767 dec.

**Table 3-28.** DL205 and DL405 Data Members (Continued)

<b>Data Member</b>	<b>Type</b>	<b>Read</b>	<b>Write</b>	<b>Description</b>
V0.0 – V41230.17	logical	yes	no	Individual bits within V-memory registers—the least significant bit is 0, the most significant bit is 17 (octal).
VBCD0-VBDC41230	numeric	yes	yes	V-memory as BCD.
VD0 – VD41227	numeric	yes	yes	Double—reads two adjacent V-memory registers as a single 32-bit integer ranging from 0 to 4,294,967,296.
VDBC00-VDBC41227	numeric	yes	yes	V-memory double as BCD.
VF0 – VF41227	numeric	yes	yes	Float—reads two adjacent V-memory registers as a single 32-bit floating point value.
VU0 – VU41230	numeric	yes	yes	Unsigned—V-memory register holding 16-bit unsigned integer ranging from 0 to 65535.
X0 – X1777*	logical	yes	yes	Discrete input points—addressed in octal and mapped to V40400 – V40407.
Y0 – Y1777*	logical	yes	yes	Discrete output points—addressed in octal and mapped to V40500 – V40507.
* 205 series PLCs are limited to 128 input and output points total. You can mix these addresses as necessary, but understand that Y17 and X17 refer to the same memory location on DL205.				

## DL205 and DL405 Status Messages

### No response within timeout period

Lookout did not receive the expected response within the **Receive timeout** period. The object sent an inquiry and received an acknowledgment, but the device did not send an expected response to the request. This might happen if the response was interrupted. You may have to increase **Receive timeout**.

### **No return inquiry response from secondary unit**

Lookout received no response from the device within the **Receive timeout** period. The driver object is able to use the COM port, but when it polls the device, it does not respond—as if it is not even there. You may have to increase **Receive timeout** to ensure Lookout is allowing enough time to receive the expected response. Also, verify your baud rate settings, cable connections, power, configuration settings, COM port settings, and polling addresses.

### **Bad LRC**

The object is receiving a poll response from the device, but it could not decipher the response because it is garbled. Verify that all devices connected to the COM port have unique addresses. The last part of the message may actually be getting clipped off before it is completed. Consider increasing the number of **Retry attempts**. You may have to increase the **Receive gap** Serial Port setting to ensure Lookout is receiving the entire message. If your Serial Port is configured for radio, this could be caused by an audible squelch tail occurring at the end of a radio transmission. Try adjusting **RTS delay off** and **CTS timeout**.

### **No acknowledgment for header frame**

You sent an inquiry and some kind of data write or read, but the device has not responded. The object was expecting an acknowledgment for an instruction frame and did not receive it. You may be asking for an invalid memory address. Recheck your PLC memory address configuration. Also verify that the PLC communication port supports the CCM **Protocol** that you selected.

### **Invalid request frame**

You are probably trying to use an invalid memory address. Recheck your PLC address configuration.



# DNP

Use the DNP driver to connect to specific devices using the Distributed Network Protocol version 3.0.

**Address** specifies which device you are communicating with using this object. This number is between 0 and 255, and is set on the device.

**Source Address** specifies the DNP address of the computer running Lookout.

**Serial port** specifies which port the object uses for communication to the external device. This does not specify the communication type. You set communication type in the **Serial Ports** dialog box. Select **Options»Serial Ports** to access this dialog box.

**Baud Rate, Parity, Data bits, and Stop bits** reference the settings on the hardware device.

**Phone number** specifies the number to be dialed if the serial port setting is configured for dial-up. This number only applies to the individual protocol object.

**PollRate** is a numeric expression that determines how often to poll your DNP device. The object then polls the device at the specified time interval. Normally, this is a simple time constant such as 0:01 (one second).

See *Numeric Data Members* in Chapter 2, *How Lookout Works*, of the *Getting Started with Lookout* manual for more information.

**Poll** is a logical expression. When this expression changes from FALSE to TRUE, Lookout polls your DNP device for data from the specified device. You can use a simple expression like the signal from a pushbutton, or a complex algorithm.

The **Skip *N* poll requests after COM failure** setting instructs Lookout to not poll a device it has lost communication with on every scheduled poll. Instead, Lookout skips the device in the polling cycle. Once communications have been reestablished, the device is polled on its regular cycle.

**Retry attempts** specifies the consecutive number of times Lookout attempts to establish communications with a device if it is not getting a valid response. After it tries the number of **Retry attempts** specified, the DNP object generates an alarm and releases the communication port back to the communications service which then moves on to the next device in the polling queue (if any).

**Receive timeout** is the time delay Lookout uses in waiting for a response from a device before retrying the request.

**Communication alarm priority** determines the priority level of alarms generated by the object. Such alarms are typically related to communications with the physical device.

## DNP Data Members

**Table 3-29.** DNP Data Members

Data Member	Type	Read	Write	Description
AINDW0-AINDW65535	numeric	yes	no	32-bit analog input (object 30, variation 3)
AINFDW0-AINFDW65535	numeric	yes	no	32-bit analog input with flag (object 30, variation 1)
AINFW0-AINFW65535	numeric	yes	no	16-bit analog input with flag (object 30, variation 2)
AINW0-AINW65535	numeric	yes	no	16-bit analog input (object 30, variation 4)

**Table 3-29.** DNP Data Members (Continued)

<b>Data Member</b>	<b>Type</b>	<b>Read</b>	<b>Write</b>	<b>Description</b>
AOUTFDW0-AOUTFDW65535	numeric	yes	yes	32-bit analog output with flag (object 40, variation 1)
AOUTFW0-AOUTFW65535	numeric	yes	yes	16-bit analog output with flag (object 40, variation 2)
BIN0-BIN65535	logical	yes	no	Binary input (object 1, variation 1)
BINS0-BINS65535	logical	yes	no	Binary input with status (object 1, variation 2)
BOUT0-BOUT65535	logical	yes	yes	Binary output (object 10, variation 1)
BOU0S0-BOU0S65535	logical	yes	yes	Binary output with status (object 10, variation 2)
CNTDW0-CNTDW65535	numeric	yes	no	32-bit counter (object 20, variation 5)
CNTFDW0-CNTFDW65535	numeric	yes	no	32-bit counter with flag (object 20, variation 1)
CNTFW0-CNTFW65535	numeric	yes	no	16-bit counter with flag (object 20, variation 2)
CNTW0-CNTW65535	numeric	yes	no	16-bit counter (object 20, variation 6)
CommFail	logical	yes	no	Object-generated signal that is on if, for whatever reason, Lookout cannot communicate with your DNP device.
DCNTDW0-DCNTDW65535	numeric	yes	no	32-bit delta counter (object 20, variation 7)
DCNTFDW0-DCNTFDW65535	numeric	yes	no	32-bit delta counter with flag (object 20, variation 3)
DCNTFW0-DCNTFW65535	numeric	yes	no	16-bit delta counter with flag (object 20, variation 4)
DCNTW0-DCNTW65535	numeric	yes	no	16-bit delta counter (object 20, variation 8)
FL0-FL65535	numeric	yes	yes	64-bit float (object 100, variation 2)
FS0-FS65535	numeric	yes	yes	32-bit float (object 100, variation 1)

**Table 3-29.** DNP Data Members (Continued)

<b>Data Member</b>	<b>Type</b>	<b>Read</b>	<b>Write</b>	<b>Description</b>
Poll	logical	no	yes	When this value transitions from FALSE to TRUE, Lookout polls the device.
PollRate	numeric	no	yes	Lookout expression that determines the device polling frequency.
TIMEDATE	numeric	yes	no	Device time and date (in Lookout time format) (object 50, variation 1)
Update	logical	yes	no	Object-generated signal that pulses low each time it polls the device.

## Error Messages

### No response within timeout period

Lookout received no response from a device within the **Receive timeout** period. The DNP object is able to use the COM port, but when it polls the device, it doesn't respond—as if it is not there. If you have daisy-chained several devices, you have introduced an inherent delay. You may have to significantly increase **Receive timeout** (and **Poll Rate**) to ensure Lookout is allowing enough time to receive the expected response. This increase has nothing to do with the processing capabilities of Lookout. It is based solely on **Baud rate** and the number of devices on the chain. Also, verify your baud rate settings, cable connections, power, configuration settings, COM port settings, and polling addresses.

### FT3 Error: No start bytes

The driver could not find the bytes that signify the beginning of a DNP frame in a response received from the device. This kind of garbled frame might be caused by bad communications settings.

### FT3 Error: FCB fail

The Frame Count Bit (FCB) in the received frame was wrong. This bit helps to ensure that messages are sent and received in the right order. If you are consistently seeing this error you may have a lot of quiescent traffic on the network that is disrupting the driver.

### FT3 Error: Bad destination byte

The DNP driver received a message that was not addressed to it.

**FT3 Error: Bad source bytes**

The DNP driver received a message that was not from the device that this object is monitoring.

**FT3 Error: CRC fail**

One of the FT3 level checksums failed. If this happens consistently, verify your communications link and settings.

**FT3 Error: Bad transport header sequence number**

The sequence number in the transport header in the received frame was wrong. This number helps to ensure that messages are sent and received in the right order. If you are consistently seeing this error you may have a lot of quiescent traffic on the network that is disrupting the driver.

**FT3 Error: Bad application control sequence number**

The sequence number in the application control byte in the received frame was wrong. This number helps to ensure that messages are sent and received in the right order. If you are consistently seeing this error you may have a lot of quiescent traffic on the network that is disrupting the driver.

**FT3 Error: Bad DIR**

The DIR bit identifies a message as from the master or from a slave. If you get this error you may have multiple masters set up on your network.

**FT3 Error: Bad PRM**

The PRM bit identifies a message as from an initiating station or from a secondary station. If you get this error you may have multiple masters set up on your network.

# Dynamic

---

Dynamic is a protocol driver class Lookout uses to communicate with equipment such as programmable logic controllers (PLCs), remote terminal units (RTUs), or any other piece of equipment that uses Dynamic as its communication protocol.

Protocol driver objects contain a great deal of data. All readable and writable members (inputs/outputs), polling instructions, read/write blocking, serial port usage, etc. are bundled with the object. Therefore, as soon as you create a Dynamic object you immediately have access to all the object data members (see data member list in this section).

The driver currently supports reading and writing of all predefined data point types including analog input, state input, pulse count input, pulse duration input, pulse period input, high speed accumulator inputs, state outputs, pulse outputs, analog outputs, and AGA data.

The driver automatically configures the RTU database to match the data points referenced in the Lookout process file and verifies that the points specified in the process file actually exist on the RTU. If you reference undefined or unavailable points, the driver posts an alarm message to the Lookout alarm system.

The Dynamic protocol driver automatically takes advantage of the RTU exception reporting capabilities to maximize communication efficiency. The driver requires that the RTU be set for physical point addressing—refer to the RTU hardware technical reference manual for the dipswitch locations that set this parameter.



**Note** Lookout protocol driver objects automatically generate an efficient read/write blocking scheme based on the inputs and outputs being used in your process file. You are not required to build your own I/O blocking table.

The Dynamic protocol driver was written for Texas Instruments Model 8635, 8640 and 8641 RTUs (Remote Terminal Units) with RTX 5.41 EPROMs—earlier releases of RTX have significant bugs and do not operate correctly with the Lookout Dynamic driver.

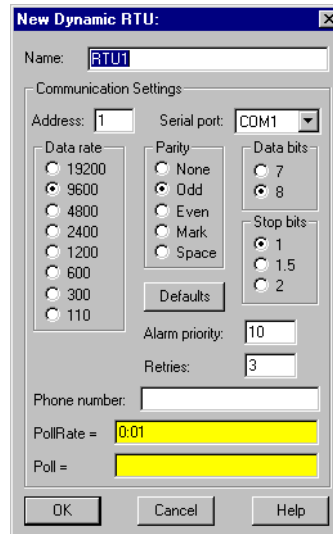

**Figure 3-12.** Dynamic Parameter Configuration Dialog Box

In this example Lookout is connected to a Dynamic-speaking RTU with an address of 7. Lookout is using serial port1 (which was previously configured for Dial-up communications), and calling the specified phone number. Each poll occurs every 1 hour or when the operator depresses Pushbutton7.

**Address** refers to the PLC or RTU address setting as set on the device dipswitches. If devices share a common line, they require unique addresses (1 to 255).

**Serial port** specifies which port the object uses for communication to the external device. This does not specify the communication type. Communication type is determined by the **Options»Serial Ports...** command.

**Data rate, Parity, Data bits, and Stop bits** reference the settings on the hardware device.

The **Defaults** button replaces the current settings with default values.

**Alarm priority** determines the priority level of Dynamic-generated alarms.

**Phone number** specifies the number to be dialed if the serial port setting is configured for dial-up. This number only applies to the individual protocol object.

**PollRate** is a numeric expression that determines how often to poll the device. Dynamic then polls the device at the specified time interval. Normally, this is a simple time constant such as 0:01 (one second). See *Numeric Data Members* in Chapter 2, *How Lookout Works*, of the *Getting Started with Lookout* manual for information on entering time constants.

**Poll** is a logical expression. When this expression changes from false to true, Lookout polls the device. You can use a simple expression like the signal from a pushbutton, or a complex algorithm.

As with all Lookout drivers, you can access I/O points and other data through data members. The following is a table of data members currently supported by the Dynamic object class.

## Dynamic Data Members

**Table 3-30.** Dynamic Data Members

Data Members	Type	Read	Write	Description
AI0 – AI239	numeric	yes	no	Analog inputs—returns a normalized numeric value that ranges from 0 to 32000 and spans the full input analog range.
AO0 – AO239	numeric	no	yes	Analog outputs—sets voltage level of analog outputs, and accepts a normalized number from 0 to 32000.
btu1 – btu4	numeric	yes	no	AGA data
dp1 – dp4	numeric	yes	no	Differential pressure (psi). 1 – 4 specifies meter run being referenced.
HSA0 – HSA127	numeric	yes	no	High-speed accumulator inputs—counts the number of digital pulses on an HSA input. Rollover is detected automatically by driver, so maximum pulse count is $4.5 \times 10^{15}$ .



**Table 3-30.** Dynamic Data Members (Continued)

<b>Data Members</b>	<b>Type</b>	<b>Read</b>	<b>Write</b>	<b>Description</b>
MeterCode1 – MeterCode4	text	no	yes	First 8 characters of this text string are used to create a filename with a <code>.csv</code> extension. Entire text string is used as a field within the <code>.csv</code> file. 1 – 4 specifies meter run being referenced.
NoComm	logical	yes	no	Driver-generated signal that is on if Lookout cannot communicate with the device for whatever reason.
PCI0 – PCI239	numeric	yes	no	Digital pulse count inputs—counts the number of times a digital state input has transitioned from <code>off</code> to <code>on</code> . Rollover is detected automatically by driver, so maximum pulse count is about $4.5 \times 10^{15}$ .
PDI0 – PDI239	numeric	yes	no	Digital pulse duration inputs—measures a periodic pulse on time with a 10 msec resolution. Pulse period should be 15 seconds or less. Returned time is in standard Lookout time units of fraction of a day.
Poll	logical	no	yes	When this value transitions from <code>FALSE</code> to <code>TRUE</code> Lookout polls the device.
PollRate	numeric	no	yes	Lookout expression that determines the frequency at which the device is to be polled.
PPI0 – PPI239	numeric	yes	no	Digital pulse period inputs—measures a pulse period with a 10 msec resolution. Pulse period should be 15.1 seconds or less. Returned time is in standard Lookout time units of fraction of a day.
Qe1 – Qe4	numeric	yes	no	Energy rate 1 – 4 specifies meter run being referenced.

**Table 3-30.** Dynamic Data Members (Continued)

<b>Data Members</b>	<b>Type</b>	<b>Read</b>	<b>Write</b>	<b>Description</b>
Qsum1 – Qsum4	numeric	yes	no	Accumulated flow over the last 60 minutes (cubic feet – CF). 1 – 4 specifies meter run being referenced.
Qsum_month1 – Qsum_month4	numeric	yes	no	Accumulated flow over the last 30 days (cubic feet – CF). 1 – 4 specifies meter run being referenced.
Qsum_yesterday1– Qsum_yesterday4	numeric	yes	no	Accumulated flow over the last 24 hours (cubic feet – CF). 1 – 4 specifies meter run being referenced.
Qv1 – Qv4	numeric	yes	no	Instantaneous flow rate (cubic feet/hour – CFH). 1 – 4 specifies meter run being referenced.
ReadHistory	logical	no	yes	When this value transitions from TRUE to FALSE, Lookout polls the device and reads the historical AGA from the RTU, storing to disk.
SI0 – SI239	logical	yes	no	Digital state inputs
SO0 – SO239	logical	no	yes	Digital state outputs. On the 8635, state outputs and pulse outputs are mapped to programmable I/O (PIO) points and range from SO8 to SO15.
sp1 – sp4	numeric	yes	no	Static pressure (psi). 1 – 4 specifies meter run being referenced.
tf1 – tf4	numeric	yes	no	Flowing temperature (deg. F). 1 – 4 specifies meter run being referenced.
Update	logical	yes	no	Driver-generated signal that pulses each time the driver polls the device
VB0-VB65535	logical	yes	yes	Bit in V register read as logical.
VF0-VF2047	numeric	yes	yes	V register read as float on 4-byte boundary.
VFN0-VFN2047	numeric	yes	yes	V register read as float, no boundary.

**Table 3-30.** Dynamic Data Members (Continued)

<b>Data Members</b>	<b>Type</b>	<b>Read</b>	<b>Write</b>	<b>Description</b>
VW0-VW4095	numeric	yes	yes	V register read as a word on 2-byte boundary.
VWN0-VWN4095	numeric	yes	yes	V register read as a word, no boundary.

## Fatek MA/MB/MC

---

Use the Fatek driver object class to communicate with Fatek PLCs. While each series has its own create object dialog box, all of the Fatek driver object classes are configured in the same way.

**Station sets the PLC address. Select the correct PLC Model** from the choices listed, which include FB-20MA, FB-28MA, FB-40MA, FB-20MB, FB-28MB, FB-40MB, FB-20MC, FB-28MC, and FB-40MC.

**Serial port** specifies which COM port on the host computer that Lookout object uses for communicating to the external device. This does not specify the communication type. Communication type is determined by the **Options»Serial Ports** command. See Chapter 3, *Serial Port Communication Service*, of the *Lookout Developer's Manual* for more information on configuring your serial ports for use with Lookout.

**Data rate, Parity, Data bits, and Stop bits** reference the settings on the hardware device.

**Phone** specifies the telephone number to be dialed if the selected serial port is configured for dial-up. This number only applies to the individual protocol object.

**PollRate** is a numeric expression that determines how often to poll the device. Lookout polls the device at the specified time interval. Normally, this is a simple time constant such as 0:01 (one second). See *Numeric Data Members* in Chapter 2, *How Lookout Works*, of the *Getting Started with Lookout* manual for information on entering time constants.

**Poll** is a logical expression. When this expression changes from false to true, Lookout polls the device. Use a simple expression like the signal from a pushbutton, or a complex algorithm.

**Communication alarm priority** determines the priority level of the alarms generated by the Fatek object.

**Retry attempts** specifies the consecutive number of times Lookout attempts to establish communication with a device if it is not getting a valid response. After the specified number of **Retry attempts**, the object generates an alarm and begins to **Skip every *n* poll requests after comm failure**. Once Lookout reestablishes communication, it polls the device on the regular cycle specified in **PollRate**.

**Receive timeout** is the time delay that Lookout waits for a response from a device before retrying the poll request.

**The Skip every** setting instructs Lookout not to poll a device it has lost communication with on every scheduled poll. Instead, Lookout polls the device once in the specified number of poll cycles. Once communication has been reestablished, the device is polled on the specified cycle.

## Fatek Data Members

A few of the following data members are available only in MB and MC series PLCs. This restriction is noted in the Description column.

**Table 3-31.** Fatek Data Members

Data Member	Type	Read	Write	Description
C0-C255	logical	yes	no	Discrete counter.
CommFail	logical	yes	no	Object-generated signal that is on if Lookout cannot communicate with the device.
CTR0-CTR199	numeric	yes	yes	16-bit register.
DCTR0-DCTR255	numeric	yes	no	32-bit register.
DHR0-DHR3838	numeric	yes	yes	32-bit Data register.
DHSCR4096-DHSCR4126	numeric	yes	yes	(MB and MC series PLCs only) 32-bit High speed counter register.
DIR3840-DIR3846	numeric	yes	no	32-bit Input register.
DOR3904-DOR3910	numeric	yes	yes	32-bit Output register.
DROR5000-DROR8070	numeric	yes	no	32-bit Read-only register.
DSR4136-DSR4166	numeric	yes	yes	32-bit Special register.
DTMR0-DTMR254	numeric	yes	yes	32-bit Timer register.
DWM0-DWN1368	numeric	yes	yes	32-bit Internal relay (DW).
DWS0-DWS968	numeric	yes	yes	32-bit Step relay (DW).

**Table 3-31.** Fatek Data Members (Continued)

<b>Data Member</b>	<b>Type</b>	<b>Read</b>	<b>Write</b>	<b>Description</b>
DWSM1912-DWSM1968	numeric	yes	yes	32-bit Special relay (DW).
DWX0-DWX128	numeric	yes	yes	32-bit Input (DW).
DWY0-DWY128	numeric	yes	yes	32-bit Output relay (DW).
HRO-HR3839	numeric	yes	yes	16-bit Data register.
HSCR4096-HSCR4126	numeric	yes	yes	(MB and MC series PLCs only) 16-bit High speed counter register.
IR3840-IR3847	numeric	yes	no	16-bit Input register.
M0-M1399	logical	yes	yes	Internal relay.
OffHook	logical	no	yes	When TRUE, this flag instructs the Fatek object to retain exclusive use of its assigned communication port.
OR3904-OR3911	numeric	yes	yes	16-bit Output register.
Poll	logical	no	yes	When this value transitions from FALSE to TRUE, Lookout polls the device.
PollRate	numeric	no	yes	Lookout expression that determines the device polling frequency.
ROR5000-ROR8071	numeric	yes	no	16-bit Read-only register.
RTCR4128-RTCR4135	numeric	yes	no	(MB and MC series PLCs only) 16-bit Real time clock register.
S0-S999	logical	yes	yes	Step relay.
SM1912-SM2001	logical	yes	yes	Special relay.
SR436-SR4167	numeric	yes	yes	16-bit Special register.
T0-T255	logical	yes	no	Discrete timer.
TMR0-THR255		yes	yes	16-bit Timer register.

**Table 3-31.** Fatek Data Members (Continued)

Data Member	Type	Read	Write	Description
Update	logical	yes	no	Object-generated signal that pulses low each time it polls the device.
WM0-WM1384	numeric	yes	yes	16-bit Internal relay (W).
WS0-WS984	numeric	yes	yes	16-bit Step relay (W).
WSM1912- WSM1984	numeric	yes	yes	16-bit Special relay (W).
WX0-WX144	numeric	yes	no	16-bit Input (W).
WY0-WY144	numeric	yes	yes	16-bit Output relay (W).
X0-X159	logical	yes	no	Discrete inputs.
Y0-Y159	logical	yes	yes	Output relay.

## Fatek Status Messages

Lookout returns the following status messages for the Fatek driver object.

### No response from PLC

Lookout received no response from the device within the **Receive timeout** period. The object was able to establish a connection, but when it sent a message to the device, the device did not respond. Significantly increase **Receive timeout**, and **Poll Rate**, to ensure Lookout is allowing enough time to receive the expected response. Also, verify the cable connections, serial port wiring, power supply, configuration settings, and IP settings.

### Unexpected response from PLC

A response was received from the PLC, but it was not the response expected according to the protocol.

### Bad frame

A response frame was received from the PLC, but the frame is not valid according to the protocol. This is usually caused by a truncated frame. Increase the **Receive Gap** setting in the **Options»Serial Ports** dialog box.

### Bad BCC

The BCC computed by the object for a received frame does not match the BCC in the frame.

### **PLC Alarms**

The following alarms originate in the PLC, and are passed along immediately by the object. There are no retry attempts. Consult the PLC documentation for more details on these and other PLC errors:

**Checksum error**

**Illegal value**

**Write protection**

**Illegal command format**

**Cannot run**

**Illegal address**

**Cannot back up as program contains password**



# FisherROC

FisherROC is a protocol driver class Lookout uses to communicate with a ROC364 (Remote Operations Controller) made by Fisher Controls. To communicate with the ROC364, connect directly to its COM1 or COM2 port. Depending on the device configuration, these ports may be configured for RS-232, RS-422/485 or Bell 202 modem communications.

Create one FisherROC object for each ROC364. This object class contains a great deal of data. All point types including inputs, outputs, PID, AGA, Tank, and their configuration signals are bundled with the object. Therefore, as soon as you create a FisherROC object you immediately have access to the object data member set.

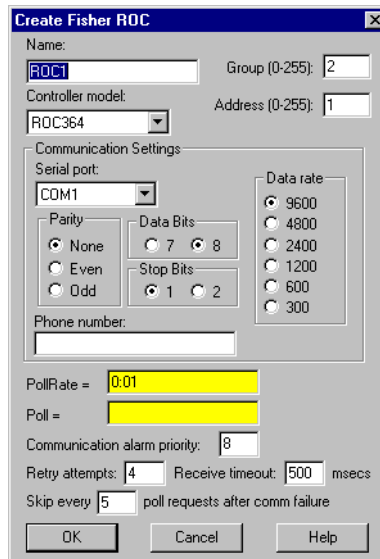

**Figure 3-13.** FisherROC Definition Parameters Dialog Box

**Group** is the group code to which the ROC station is assigned. This is typically set to 2, but is configurable through the GV101 Configuration software.

**Address** is the unit code (address setting) of the ROC station as defined using the GV101 Configuration software. If multiple ROCs are members of the same group, then they must have unique addresses (0 to 255). As the host station, the Lookout computer is assigned Group 0, Address 1.

**Controller model** identifies the type of Fisher remote operations controller that the object represents. This object class supports **ROC364**.

**Serial port** specifies which COM port on the host computer that Lookout object uses for communicating to the external device. This does not specify the communication type. Communication type is determined by the **Options»Serial Ports...** command.

**Data rate, Parity, Data bits, and Stop bits** reference the settings on the hardware device.

**Phone number** specifies the number to be dialed if the selected serial port is configured for dial-up. This number only applies to the individual protocol object.

**PollRate** is a numeric expression that determines how often to poll the device. The object then polls the device at the specified time interval. Normally, this is a simple time constant such as 0:01 (one second). See *Numeric Data Members* in Chapter 2, *How Lookout Works*, of the *Getting Started with Lookout* manual for information on entering time constants.

**Poll** is a logical expression. When this expression changes from FALSE to TRUE, Lookout polls the device. You can use a simple expression like the signal from a pushbutton, or a complex algorithm.

**Communication alarm priority** determines the priority level of alarms generated by the object. Such alarms are typically related to communications with the physical device.

**Retry attempts** specifies the consecutive number of times Lookout attempts to establish communications with a device if it is not getting a valid response. After it tries the number of **Retry attempts** specified, the object generates an alarm and releases the communication port back to the communications service which then moves on to the next device in the polling queue (if any). Refer to Chapter 3, *Serial Port Communication Service*, in the *Lookout Developer's Manual* for more information.

**Receive timeout** is the time delay Lookout uses in waiting for a response from a device before retrying the request.

The **Skip every...** setting instructs Lookout to not poll a device it has lost communication with on every scheduled poll. Instead, Lookout skips the device in the polling cycle accordingly. Once communications have been reestablished, the device is polled on its regular cycle.

## FisherROC Data Members

**Table 3-32.** FisherROC Data Members

Data Member	Type	Read	Write	Description
AGA0.ha-AGA4.ha	numeric	yes	yes	Age high alarm
AGA0.la – AGA4.la	numeric	yes	yes	AGA low alarm EU value
AGF0.btud – AGF4.btud	numeric	yes	no	AGA Flow in units of MMBTU/Day
AGF0.btut – AGF4.btut	numeric	yes	no	MMBTUs of AGA Flow today
AGF0.btuy – AGF4.btuy	numeric	yes	no	MMBTUs of AGA Flow yesterday
AGF0.mcf – AGF4.mcf	numeric	yes	no	AGA Flow in units of MCF/Day
AGF0.mcft – AGF4.mcft	numeric	yes	no	MCFs of AGA Flow today
AGF0.mcfy – AGF4.mcfy	numeric	yes	no	MCFs of AGA Flow yesterday
AI:A1.adh – AI:D16.adh	numeric	yes	yes	Analog input adjusted A/D 100%
AI:A1.adl – AI:D16.adl	numeric	yes	yes	Analog input adjusted A/D 0%
AI:A1.dla – AI:D16.dla	numeric	yes	yes	Analog input Delta Alarm EU
AI:A1.euh – AI:D16.euh	numeric	yes	yes	Analog input High Reading EU
AI:A1.eul – AI:D16.eul	numeric	yes	yes	Analog input Low Reading EU
AI:A1.feu – AI:D16.feu	numeric	yes	yes	Analog input Filtered EU value
AI:A1.flt – AI:D16.flt	numeric	yes	yes	Analog input Filter
AI:A1.ha – AI:D16.ha	numeric	yes	yes	Analog input High alarm limit
AI:A1.hha – AI:D16.hha	numeric	yes	yes	Analog input High-High alarm limit
AI:A1.la – AI:D16.la	numeric	yes	yes	Analog input Low alarm limit
AI:A1.lla – AI:D16.lla	numeric	yes	yes	Analog input Low-Low alarm limit
AI:A1.raw – AI:D16.raw	numeric	yes	no	Analog input Raw A/D input value
AO:A1.adh – AO:D16.adh	numeric	yes	yes	Analog output Adjusted A/D 100%
AO:A1.adl – AO:D16.adl	numeric	yes	yes	Analog output Adjusted A/D 0%
AO:A1.eu – AO:D16.eu	numeric	yes	yes	Analog output EU output value
AO:A1.euh – AO:D16.euh	numeric	yes	yes	Analog output High Reading EU

**Table 3-32.** FisherROC Data Members (Continued)

<b>Data Member</b>	<b>Type</b>	<b>Read</b>	<b>Write</b>	<b>Description</b>
AO:A1.eul – AO:D16.eul	numeric	yes	yes	Analog output Low Reading EU
CommFail	logical	yes	no	Object-generated signal that is on if, for whatever reason, Lookout cannot communicate with the ROC
DI:A1.acc – DI:D16.acc	numeric	yes	yes	Discrete input accumulated value
DI:A1.flt – DI:D16.flt	logical	yes	yes	Discrete input filter
DI:A1.ha – DI:D16.ha	numeric	yes	yes	Discrete input high alarm
DI:A1.hha – DI:D16.hha	numeric	yes	yes	Discrete input high-high alarm
DI:A1.la – DI:D16.la	numeric	yes	yes	Discrete input low alarm
DI:A1.lla – DI:D16.lla	numeric	yes	yes	Discrete input low-low alarm
DI:A1.sts – DI:D16.sts	logical	yes	no	Discrete input status (value)
DO:A1.acc – DO:D16.acc	numeric	yes	yes	Discrete output accumulated value
DO:A1.cth – DO:D16.cth	numeric	yes	yes	Discrete output 100% count
DO:A1.ctl – DO:D16.ctl	numeric	yes	yes	Discrete output 0% count
DO:A1.ctm – DO:D16.ctm	numeric	yes	yes	Discrete output cycle time
DO:A1.eu – DO:D16.eu	numeric	yes	yes	Discrete output EU value
DO:A1.rdh – DO:D16.rdh	numeric	yes	yes	Discrete output high reading EU
DO:A1.rdl – DO:D16.rdl	numeric	yes	yes	Discrete output low reading EU
DO:A1.sts – DO:D16.sts	logical	yes	yes	Discrete output status (value)
DO:A1.to – DO:D16.to	numeric	yes	yes	Discrete output time on
FST1.rg1 – FST8.rg10	numeric	yes	yes	Function seq. table register value
FST1.rrg – FST8.rrg	numeric	yes	yes	Function seq. table result register
FST1.tm1 – FST8.tm4	numeric	yes	yes	Function seq. table timer value
PID0.eu – PID15.eu	numeric	yes	yes	PID output EU value
PID0.ost – PID15.ost	numeric	yes	yes	PID OVR sw setpoint
PID0.pst – PID15.pst	numeric	yes	yes	PID PRI sw setpoint

**Table 3-32.** FisherROC Data Members (Continued)

<b>Data Member</b>	<b>Type</b>	<b>Read</b>	<b>Write</b>	<b>Description</b>
PID0.set – PID15.set	numeric	yes	yes	PID setpoint value
PL:A1.acc – PL:D16.acc	numeric	yes	yes	Pulse input accumulated value
PL:A1.crt – PL:D16.crt	numeric	yes	no	Pulse input current rate
PL:A1.dla – PL:D16.dla	numeric	yes	yes	Pulse input delta alarm EU
PL:A1.eu – PL:D16.eu	numeric	yes	yes	Pulse input value in engineering units
PL:A1.ha – PL:D16.ha	numeric	yes	yes	Pulse input high alarm EU value
PL:A1.hha – PL:D16.hha	numeric	yes	yes	Pulse input high-high alarm EU value
PL:A1.la – PL:D16.la	numeric	yes	yes	Pulse input low alarm EU value
PL:A1.lla – PL:D16.lla	numeric	yes	yes	Pulse input low-low alarm EU value
PL:A1.rpd – PL:D16.rpd	numeric	yes	yes	Pulse input rate period
Poll	logical	no	yes	When this value transitions from FALSE to TRUE, Lookout polls the device.
PollRate	numeric	no	yes	Lookout expression that determines the device polling frequency.
SPT1.d1 – SPT32.d20	numeric	yes	yes	Soft point parameter data number
TNK0.cfl – TNK7.cfl	numeric	yes	no	Tank current fluid level
TNK0.dis – TNK7.dis	numeric	yes	no	Tank barrels discharged
TNK2.dla – TNK7.dla	numeric	yes	yes	Tank delta alarm EU
TNK0.lsl – TNK7.lsl	numeric	yes	no	Tank last scan level
TNK0.man – TNK7.man	numeric	yes	yes	Tank manual entry—barrels
TNK0.ttl – TNK7.ttl	numeric	yes	no	Tank total barrels hauled
TNK0.tvl – TNK7.tvl	numeric	yes	no	Today's tank volume
TNK0.yvl – TNK7.yvl	numeric	yes	no	Yesterday's tank volume
Update	logical	yes	no	Object-generated signal that pulses low each time it polls the device

## Compatibility Note

A correction in how Lookout indexes device registers for Fisher ROC PLCs was made in Lookout versions 4.0.1 and later. In previous versions, Lookout did not have any data members mapped to control device 0, but did have data members mapped to a non-existent register 5.

The data members affected are:

- All AGA members
- All AGF members
- All TNK members
- All PID members
- FST1.rrg - FST8.rrg

For example Lookout previously used AGA data members numbered AGA1-AGA5 where the PLC registers are numbered AGA0-AGA4. In Lookout 4.0.1, the AGA5 data member has been removed, and an AGA0 data member has been added.

**Comments** To read the raw value of an analog input located at I/O module socket 9 on the third mounting rack, you would enter `NAME.AI:C9.raw`, where

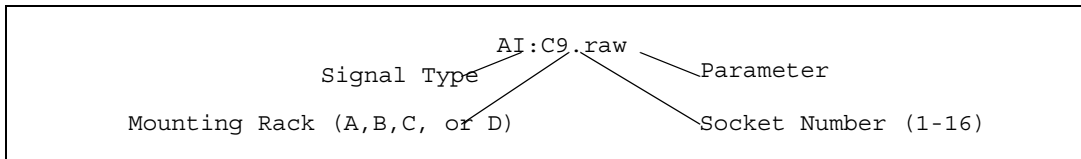

## FisherROC Status Messages

### No response within timeout period

Lookout received no response from the ROC device within the **Receive timeout** period. The driver object is able to use the COM port, but when it polls the device, it does not respond—as if it is not even there. You may have to increase **Receive timeout** to ensure Lookout is allowing enough time to receive the expected response. Also, verify your baud rate settings, cable connections, power, configuration settings, COM port settings, and polling addresses.

**Message Garbled—Bad CRC**

The object is receiving a poll response from the device, but it cannot decipher the response. Verify that all devices assigned to the device group have unique unit codes. The last part of the message may actually be getting clipped off before it is completed. Consider increasing the number of **Retry attempts**. You may have to increase the **Receive gap** Serial Port setting to ensure Lookout is receiving the entire message. If your Serial Port is configured for radio, this could be caused by an audible squelch tail occurring at the end of a radio transmission. Try adjusting **RTS delay off** and **CTS timeout**.

**Unexpected data response length**

The object is receiving a poll response from the device, but the response is too long. Verify that all devices connected to the COM port and assigned to the same device group have unique unit codes. Devices with identical addresses may be trying to respond at the same time. Also verify device protocol settings.

**Response too short**

The object is receiving data of a length that does not meet the minimum frame length requirements. Verify device protocol settings. You may have to increase **Receive timeout**.

**Return unit address incorrect****Return group address incorrect**

The object sent a data write or data read request, but the ROC did not respond. You may be asking for an invalid memory address. Recheck your ROC address configuration.

**Invalid module or point requested**

You attempted a data type mismatch. For example, you may have tried to write or read an *analog* value to or from a rack I/O socket that has a *discrete* module installed, or visa versa. This is an addressing problem. Verify that the type of I/O at the desired socket matches the signal type of the address identified in the data member you are writing to.

**Unexpected opcode in response: xx**

The object is receiving a poll response from the device, but the response was not expected. This might happen if the object receives a poll response after the **Receive timeout** period expires. You may have to increase **Receive timeout**. Another possibility is that the ROC is attempting an unsolicited communication. The FisherROC object class currently does not support unsolicited report-by-exception.

## GE\_Series90

GE\_Series90 is a protocol driver class Lookout uses to communicate with GE Series 90-30 and GE Series 90-70 programmable logic controllers (PLCs) using SNPX, a Series Ninety Protocol.

**Figure 3-14.** GE\_Series90 Definition Parameters Dialog Box

**PLC Address** is a slave address and refers to the PLC address setting as configured on the device. The address can be up to eight ASCII characters.

**Model** chooses either 90-30 or 90-70.

**Interface** selects the protocol. You can choose between SNPX and Ethernet.

**Serial port** specifies which port the object uses for communication to the external device. This does not specify the communication type. Communication type is determined by the **Options»Serial Ports...** command.

**Data rate, Parity, Data bits, and Stop bits** reference the settings on the hardware device.



**Phone number** specifies the number to be dialed if the serial port setting is configured for dial-up. This number only applies to the individual protocol object.

**PollRate** is a numeric expression that determines how often to poll the device. GE\_Series90 then polls the device at the specified time interval. Normally, this is a simple time constant such as 0:01 (one second). See *Numeric Data Members* in Chapter 2, *How Lookout Works*, of the *Getting Started with Lookout* manual for information on entering time constants.

**Poll** is a logical expression. When this expression changes from FALSE to TRUE, Lookout polls the device. You can use a simple expression like the signal from a pushbutton, or a complex algorithm.

**Communication alarm priority** determines the priority level of object-generated alarms (0 – 10).

**Retry attempts** specifies the consecutive number of times Lookout attempts to establish communications with a device if it is not getting a valid response. After it tries the number of **Retry attempts** specified, the GE\_Series90 object generates an alarm and releases the communication port back to the communications service which then moves on to the next device in the polling queue (if any). Refer to Chapter 3, *Serial Port Communication Service*, in the *Lookout Developer's Manual* for more information.

**Receive timeout** is the time delay Lookout uses in waiting for a response from a device before retrying the request.

The **Skip every...** setting instructs Lookout to not poll a device it has lost communication with on every scheduled poll. Instead, Lookout skips the device in the polling cycle accordingly. Once communications have been reestablished, the device is polled on its regular cycle.

## GE\_Series90 Data Members

This protocol driver object contains a great deal of data. All readable and writable members (inputs/outputs), polling instructions, read/write blocking, serial port usage, and so on, are bundled with the object. Therefore, as soon as you create a GE\_Series90 object you immediately have access to all the object data members (see data member list in Table 3-33).



**Note** Lookout protocol driver objects automatically generate an efficient read/write blocking scheme based on the inputs and outputs being used in your process file. You are not required to build your own I/O blocking table.

**Table 3-33.** GE\_Series90 Data Members

<b>Data Member</b>	<b>Type</b>	<b>Read</b>	<b>Write</b>	<b>Description</b>
AI1-AI2048	numeric	yes	no	16-bit analog value encoded as unsigned binary integers ranging from 0 to 65535
AID1-AID2047	numeric	yes	no	16-bit analog value encoded as unsigned binary integers ranging from 0 to 65535
AQ1-AQ512	numeric	yes	yes	16-bit analog outputs encoded as unsigned binary integers ranging from 0 to 65535
AQD1-AQD511	numeric	yes	yes	16-bit analog outputs encoded as unsigned binary integers ranging from 0 to 65535
AI1 – AI64	numeric	yes	yes	16-bit analog inputs encoded as unsigned binary integers ranging from 0 to 65535
AID1 – AID64	numeric	yes	yes	32-bit analog inputs encoded as unsigned binary integers ranging from 0 to 65535
AIF1-AIF2047	numeric	yes	no	32-bit analog output encoded as float value
AIU1-AIU2047	numeric	yes	no	32-bit analog output encoded as unsigned binary long ranging from 0 to 0xFFFFFFFF
AQ1 – AQ64	numeric	yes	yes	16-bit analog outputs encoded as unsigned binary integers ranging from 0 to 65535
AQD1 – AQD64	numeric	yes	yes	32-bit analog outputs encoded as unsigned binary integers ranging from 0 to 65535

**Table 3-33.** GE\_Series90 Data Members (Continued)

<b>Data Member</b>	<b>Type</b>	<b>Read</b>	<b>Write</b>	<b>Description</b>
AQF1-AQF511	numeric	yes	no	32-bit analog output encoded as float value
AQU1-AQU511	numeric	yes	yes	32-bit analog output encoded as unsigned binary long ranging from 0 to 0xFFFFFFFF
CommFail	logical	yes	no	Object-generated signal that is on if, for whatever reason, Lookout cannot communicate with the PLC.
I1-I4096	logical	yes	no	single-bit discrete input
I1 – I512	logical	yes	no	Single bit discrete inputs
M1 – M4096	logical	yes	yes	Single bit discrete (Internal coil)
OffHook	logical	no	yes	When TRUE, this flag instructs the GE object to retain exclusive use of its assigned communication port.
Poll	logical	no	yes	When this value transitions from FALSE to TRUE, Lookout polls the device.
PollRate	numeric	no	yes	Lookout expression that determines the device polling frequency.
Q1-Q4096	logical	yes	yes	single-bit discrete output
Q1 – Q512	logical	yes	yes	Single bit discrete outputs
R1 – R9999	numeric	yes	yes	16-bit holding registers encoded as unsigned binary integers ranging from 0 to 65535
RD1 – RD9998	numeric	yes	yes	32-bit holding registers encoded as unsigned binary integers ranging from 0 to 65535
RF1-RF9998	numeric	yes	no	32-bit holding registers encoded as float value
RU1-RU9998	numeric	yes	yes	32-bit holding registers encoded as unsigned binary long ranging from 0 to 0xFFFFFFFF

**Table 3-33.** GE\_Series90 Data Members (Continued)

<b>Data Member</b>	<b>Type</b>	<b>Read</b>	<b>Write</b>	<b>Description</b>
S1 – S32	logical	yes	no	System fault
SA1 – SA32	logical	yes	no	Special Contacts A
SB1 – SB32	logical	yes	no	Special Contacts B
SC1 – SC32	logical	yes	no	Special Contacts C
Update	logical	yes	no	Object-generated signal that pulses each time the driver polls the device

## GE\_Series90 Status Messages

### No response within timeout period

Lookout did not receive the expected response within the **Receive timeout** period. The object sent an inquiry and received an acknowledgment, but the device did not send an expected response to the request. This might happen if the response was interrupted. You may have to increase **Receive timeout**.

### No return inquiry response from secondary unit

Lookout received no response from the device within the **Receive timeout** period. The driver object is able to use the COM port, but when it polls the device, it does not respond—as if it is not even there. You may have to increase **Receive timeout** to ensure Lookout is allowing enough time to receive the expected response. Also, verify your baud rate settings, cable connections, power, configuration settings, COM port settings, and polling addresses.

### Bad LRC or BCC

The object is receiving a poll response from the device, but it could not decipher the response because it is garbled. Verify that all devices connected to the COM port have unique addresses. The last part of the message may actually be getting clipped off before it is completed. Consider increasing the number of **Retry attempts**. You may have to increase the **Receive gap** Serial Port setting to ensure Lookout is receiving the entire message. If your Serial Port is configured for radio, this could be caused by an audible squelch tail occurring at the end of a radio transmission. Try adjusting **RTS delay off** and **CTS timeout**.

**No attach response within timeout period**

An attempt was made to establish communications with the PLC without any response. Check your cabling and COM port selections, power, configuration settings, and polling addresses.

**Invalid response [x]**

An error in the structure of a response frame was detected. You may have two PLCs with the same address.

**Incorrect response length [x]**

A response was received with an unexpected length. You may have to increase the **Receive gap** Serial Port setting to ensure Lookout is receiving the entire message.

**Incorrect response Address**

A response was received with an address not matching the objects address. You may have two master devices on the network.

**SNPX ERROR—Major code: x Minor code: x**

The response message contained an SNPX error code. Refer to your GE documentation for the meaning of this particular error.

# Hitachi

Hitachi is a protocol driver class Lookout uses to communicate with Hitachi devices using the H series serial communication protocol.

**Figure 3-15.** Hitachi Definition Parameters Dialog Box

Set the Hitachi device timeout in the **Timeout** field.

**Loop** specifies the Hitachi device loop. Set the Hitachi **Module**, **Unit**, and **Port** values in the appropriate fields.

**Serial port** specifies which comm. port the object uses for communicating to the external device. This does not specify the communication type. Communication type is determined by the **Options»Serial Ports...** command.

**Data rate** indicates the baud rate that Lookout uses to communicate with the hardware device. This setting should match the selection made on the physical device.

**Data bits** indicates the number of data bits that Lookout uses to communicate with the hardware device. This setting should match the selection made on the physical device.

**Stop bits** indicates the number of stop bits that Lookout uses to communicate with the hardware device. This setting should match the selection made on the physical device.

**Parity** indicates the parity that Lookout uses to communicate with the hardware device. This setting should match the selection made on the physical device.

**Phone number** specifies the number to be dialed if the selected serial port is configured for dial-up. This number only applies to the individual protocol object.

**PollRate** is a numeric expression that determines how often to poll the device. The object then polls the device at the specified time interval. Normally, this will be a simple time constant such as 0:01 (one second). See *Numeric Data Members* in Chapter 2, *How Lookout Works*, of the *Getting Started with Lookout* manual for information on entering time constants.

When the logical value **Poll** transitions from FALSE to TRUE, Lookout polls the device. This can be a simple expression like the signal from a pushbutton, or it can be a complex algorithm.

**Communication alarm priority** determines the priority level of alarms generated by the Hitachi object. Such alarms are typically related to communications with the physical device.

**Retry attempts** specifies the consecutive number of times Lookout attempts to establish communications with a device if it is not getting a valid response. After it tries the number of **Retry attempts** specified, the Hitachi object generates an alarm and releases the communication port back to the communications subsystem, which then moves on to the next device in the polling queue (if any). Refer to Chapter 3, *Serial Port Communication Service*, in the *Lookout Developer's Manual* for more information.

**Receive timeout** is the time delay Lookout uses in waiting for a response from a device before retrying the request.

The **Skip every...** setting instructs Lookout to not poll a device it has lost communication with on every scheduled poll. Instead, Lookout skips the device in the polling cycle. Once communications have been reestablished, the device is polled on its regular cycle.

## Hitachi Data Members

An Hitachi object contains a great deal of data. It supports reading and writing of all predefined data points. When you create an Hitachi object, you have immediate access to all the object data members.

As with all Lookout drivers, you can access I/O points and other data through data members. The following is a table of data members currently supported by the Hitachi object class.

**Table 3-34.** Hitachi Data Members (Address Ranges in Hexadecimal)

Data Member	Type	Read	Write	Description
CommFail	logical	yes	no	Object-generated signal that is ON if Lookout cannot communicate with the device(s).
CU0 – CU512	numeric	yes	yes	Up Counter
DL0 – DL1000	numeric	yes	yes	Double-word CPU link area
DM0 – DM1000	numeric	yes	yes	Double-word data area
DR0 – DR3E	numeric	yes	yes	Internal double-word output
DX0 – DX10	numeric	yes	yes	External double-word output
DY0 – DY10	numeric	yes	no	External double-word output
L0 – L4000	logical	yes	yes	Bit CPU link area
M0 – M4000	logical	yes	yes	Bit data area
Poll	logical	no	yes	When this expression transitions from FALSE to TRUE, Lookout polls the device.
PollRate	numeric	no	yes	Lookout expression that determines the device polling frequency.
R0 – R7C0	logical	yes	yes	Internal bit output
TC0 – TC512	numeric	yes	yes	Timer counter elapsed time
TD0 – TD512	logical	yes	yes	On-Delay timer
Update	logical	yes	no	Object-generated signal that pulses low each time it polls the device.
WL0 – WL2000	numeric	yes	yes	Word CPU link area



**Table 3-34.** Hitachi Data Members (Address Ranges in Hexadecimal) (Continued)

<b>Data Member</b>	<b>Type</b>	<b>Read</b>	<b>Write</b>	<b>Description</b>
WM0 – WM2000	numeric	yes	yes	Word data area
WR0 – WR7C	numeric	yes	yes	Internal word output
WX0 – WX20	numeric	yes	yes	External word output
WY0 – WY20	numeric	yes	no	External word output
X0 – X200	logical	yes	yes	External bit input
Y0 – Y200	logical	yes	no	External bit output

## Hitachi Status Messages

**no acknowledgment for data request**

**no within timeout period**

**PLC response frame timeout**

The PLC is not responding to data requests. Check communications settings, cables, and power.

**Frame Error (Garbled): [Hitachi error code string]**

Response frame was garbled. Check cabling and cable environment.

**Hitachi frame error (RTC): [RTC error code string]**

PLC received an invalid frame. Check communications settings.

**Hitachi error message: [Hitachi error code string]**

PLC received an invalid request. Check for a data member that is out of range for the model of PLC configuration.

# IPASCI

IPASCI is a protocol driver class Lookout uses to communicate with any IP device that runs standard TCP or UDP services.

An IPASCI object contains no predefined data points. When you create a IPASCI object, you must define your data request strings as well as the template Lookout uses to parse the response frame.

**Local port** specifies which local Ethernet I/O port the object uses for communicating to the external device.

**Mode** indicates whether the object will use a TCP socket or a UDP socket.

**IP address** indicates the address of the device you wish to communicate with.

**Port** indicates the Ethernet I/O port number on the remote device where the object will try to establish a socket.

**Accept Unsolicited Messages** indicates whether or not the object will report packets from the device that are not in response to a request that the IPASCI object has sent it. This does *not* mean that the IPASCI object can act as a server. It means that once the IPASCI object has established a socket as a client, it reports unexpected data it receives from that point on.

**Communication alarm priority** determines the priority level of alarms generated by the IPASCI object. Such alarms are typically related to communications with the physical device.

**Retry attempts** specifies the number of times Lookout attempts to establish communications with a device if it is not getting a valid response. After it tries the number of **Retry attempts** specified, the IPASCII object generates an alarm and releases the socket.

**Receive timeout** is the amount of time Lookout waits for a response from a device before retrying the request.

The **Skip every \_\_\_ poll requests after comm failure** setting instructs Lookout not to poll a device it has lost communication with on every scheduled poll. Instead, Lookout polls the device only once in the specified number of poll cycles. Once communication has been reestablished, the device is polled on its regular cycle. In the context of the IPASCII object, this means that this number of Send commands will be ignored until communication has been reestablished.

## IPASCII Data Members

**Table 3-35.** IPASCII Data Members

Data Member	Type	Read	Write	Description
CommFail	logical	yes	no	Object-generated signal that is on if Lookout cannot communicate with the device(s).
Request	text	yes	no	Exact request frame sent.
RequestFormat	text	no	yes	Format used to create request frame.
Response	text	yes	no	Exact response frame received.
ResponseFormat	text	no	yes	Format used to parse response frame.
RQV1.logical— RQV100.logical—	logical	no	yes	Variable list used to populate request frame with logical values.
RQV1.txt—RQV100.txt	text	no	yes	Variable list used to populate request frame with text values.
RQV1—RQV100	numeric	no	yes	Variable list used to populate request frame with numeric values.
RSV1.logical—RSV100 .logical	logical	yes	no	Variable list used to store values retrieved from response frame.
RSV1.txt— RSV100.txt	text	yes	no	Variable list used to store values retrieved from response frame.

**Table 3-35.** IPASCII Data Members (Continued)

Data Member	Type	Read	Write	Description
RSV1—RSV100	numeric	yes	no	Variable list used to store values retrieved from response frame.
Send	logical	no	yes	Sends request frame.
Update	logical	yes	no	Object-generated signal that pulses low each time it polls the device.
* RQVn, RQVn.txt and RQVn.logical all represent the same value in different forms.				
* RSVn, RSVn.txt and RSVn.logical all represent the same value in different forms.				

## Request and Response Format Strings

The request and response format strings consist of static characters and markers that control how the request and response frames respectively are formatted or decoded. The request format string is used to *create* the request frame, which is sent to the device, while the response format string is used to *decode* the response frame, which comes from the device.

Static characters in the format strings are reproduced exactly in the request or response frame. Markers specify the location within the frame and type of data which should be found there, such as five characters read as an unsigned integer, for example. The IPASCII object constructs a request frame by processing the sequence of static characters and markers in the request format string, and including data from RQV data members.

The response format string decodes a response frame using an analogous process, storing the results in RSV data members.

To construct a request frame, the IPASCII object parses the request format string character by character. Static characters are copied directly to the request frame. When a marker is encountered the IPASCII object reads a value from the appropriate RQV variable and places it into the request frame.

There are 100 RQV and RSV values provided for in the IPASCII object data member collection. The first marker in a format string uses the value from RQV1 (or RQV1.txt or RQV1.logical), the next marker uses the value RQV2, and so on. Values taken from Response strings are stored in RSV data members in the same way.

Keep in mind that writing into `RQV1` changes the value both for `RQV1.txt` and `RQV1.logical`. Their only difference is the format in which they are represented. The same principle applies to the RSV data members.



**Note** There is no precedence to the order in which multiple objects connected to the same variable number will initialize upon opening the process file, such as the case in which a Pot object is connected to `RQV1` while a TextEntry object is connected to `RQV1.txt`. You should take care to initialize such variables to the proper value after opening a process file.

To decode a response frame, the IPASCII object compares the response frame to the response format string character by character. The static characters in the response frame must match those in the response format string or the decoding process terminates. Static characters are, in effect, discarded by the IPASCII object as they are matched between the response format string and the response frame.

When the IPASCII object encounters a marker, it places the data indicated by the marker into the appropriate RSV data member.

The conversion of a portion of the response frame to a data type specified by a marker in the response format string must be valid, or the process will terminate.

If nothing halts the process, decoding terminates when the end of the response frame string is reached.

There are examples of both request frames and response frames at the end of this section, but for the examples to make sense, you must first understand the IPASCII object markers.

## Markers

The general format for a marker is:

$$\%[\text{width}][\text{type}]$$

Each field in the marker format is a single character or a number signifying a particular format option.

The `%` sign denotes the beginning of the marker. If the percent sign is followed by a character that has no meaning as a format-control character, that character and the following characters (up to the next percent sign) are treated as static characters, that is, a sequence of characters that must match the frame exactly. For example, to specify that a percent-sign character is a static character part of the frame, use `%%`.

**Width** is a positive decimal integer specifying the number of characters that particular value occupies in the frame. By default IPASCII will pad the value with blank spaces if the value takes up fewer characters than the value specified by width. Including a 0 before the width value forces the IPASCII object to pad with zeroes instead of blank spaces.

**Type** determines whether the field is interpreted as a character, a string, or a number.

**Table 3-36.** Data Types Allowed by IPASCII

Character	Data Type
d	Decimal integer
x, X	Hexadecimal integer
u	Unsigned decimal integer
f	Floating-point
s	String
b	Byte (binary)

The simplest format specification contains only the percent sign and a type character (for example, %s). That would place the value in the response frame in the RSV1.txt data member.

Request Format String	RQV1	Request Frame
>%5d	34	> 34
>%05d	34	>00034

The request format string also has a precision value in the form **%[width].[precision][type]**. This specifies the number of digits to the right of the decimal point, if any, in the request frame. If you use a float (%f) and do not specify a precision value, the IPASCII object assumes a default of 6.

Characters are converted and stored in RSV data members from response frames in the order they are encountered in the response format. However, fewer than **[width]** characters may be read if a white-space character (space, tab, or newline) or a character that cannot be converted according to the given format occurs before **[width]** is reached.

Values needed for request frames come from the RQV data members, and are also used in the order in which they occur in the request format.

To read strings not delimited by space characters, or that contain spaces, you can substitute a set of characters in brackets ( [ ] ) s (string) type character. The corresponding input field is read up to the first character that does not appear in the bracketed character set. Using a caret (^) as the first character in the set reverses this effect: the IPASCII object reads input field up to the first character that does appear in the rest of the character set.

Response Format String	RSV1.txt	Response Frame
\$(A-Z,a-z, )\$	Natl Inst	\$Natl Inst\$
>[^,s]	days	>day

Notice that `%(a-z)` and `%(z-a)` are interpreted as equivalent to `%(abcde...z)`, and that the character set is case sensitive.



**Note** The brackets only work in response format strings. They have no effect in the request format string.

The IPASCII object scans each field in the response frame character by character. It may stop reading a particular field before it reaches a character for a variety of reasons:

- The specified width has been reached.
- The next character cannot be converted as specified.
- The next character conflicts with a character in the response format string that it is supposed to match.
- The next character fails to appear in a given character set.

No matter what the reason, when the IPASCII object stops reading an field, the next field is considered to begin at the first unread character. The conflicting character, if there is one, is considered unread and is the first character of the next field.

## Entering the Format String

For a static connection to one of the format data members, enter your format string in the yellow field box in the Edit Connections dialog box. Remember to begin and end the format strings with quotation marks so that Lookout will accept the string input.

You can also connect any valid text data member, such as a text entry object, to the format data members.

## Request Frame Construction Examples

Request Format String	RQV	Request Frame
<01%4u%s	RQV1=1234 RQV2.txt=Ross	<011234Ross
<01%04u%s	RQV1=34 RQV2.txt=Ross	<010034Ross
<01% 4u%s	RQV1=34 RQV2.txt=Ross	<01 34Ross

A zero in front of the four pads with zeroes; a space pads with spaces.

## Response Format Examples

Response Frame	Response Format String	RSV
*(16.38:	*(%5.2f:	RSV1=16.38



**Note** The decimal point counts as a character when decoding floats (%f). Also, decimal points denoting precision are not allowed when decoding a float in the response frame.

Response Frame	Response Format String	RSV
>>Test Text<<	>>%s<<	RSV1.txt=Test



The space between the words terminates the conversion. See the preceding bracketed character example in order to span a space or other special characters. The response format uses a space as a delimiter.

<b>Response Frame</b>	<b>Response Format String</b>	<b>RSV</b>
>>Test Text<<	>>%s%s<<	RSV1.txt=Test RSV2.txt=Text
>>DogCat<<	>>%3s%3s<<	RSV1.txt=Dog RSV2.txt=Cat

## IPASCII Error Messages

### No from device within timeout period

Lookout received no response from the device within the **Receive timeout** period. The IPASCII object was able to establish a socket, but when it sends its message to the device, it does not respond—as if it is not even there. You may have to significantly increase **Receive timeout** (and **Poll Rate**) to ensure Lookout is allowing enough time to receive the expected response. Also, verify your cable connections, power, configuration settings, and IP settings.

### Not enough data to send a valid frame

This means that the IPASCII object has not received enough data to fill in all the variables in the Request Format frame. This could mean that you do not have connections made to all of the RQVs that the IPASCII object is expecting.

### Socket communications error

This alarm message will be followed by a Windows standard socket error message. The most common reason you might see one of these errors is if an error has occurred on the socket after a valid socket has already been established.

### Cannot communicate with device

This means that the IPASCII object was not able to establish a valid socket with the remote device, and in fact did not get any kind of response from the device.

### Cannot resolve IP address

Check to make sure you have given IPASCII a valid IP address.

**Cannot resolve port**

Check to make sure you have given IPASCII a valid port number on the remote device.

**Garbled or unexpected response**

IPASCII got a response frame, but static characters in the response did not match up to the response format string.

**Illegally formatted string received**

IPASCII got a response frame, but certain characters in the response were not in the format stated by the markers in the response format string.

**Related Objects** [ASCII](#)

# Mitsubishi

## MitsubishiFX

Mitsubishi is a protocol driver class Lookout uses to communicate with Mitsubishi devices using the serial communication protocol.

A Mitsubishi object contains a great deal of data. It supports reading and writing of all predefined data points. When you create a Mitsubishi object, you have immediate access to all the data members for that object.

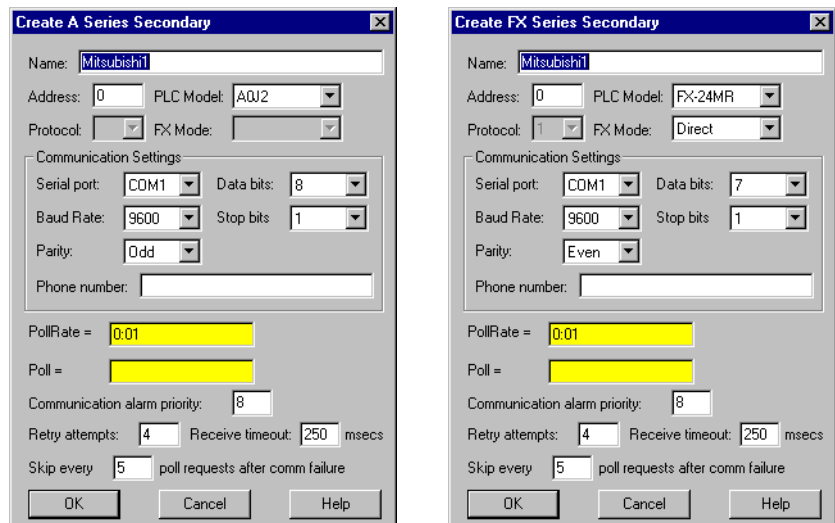

**Figure 3-16.** Mitsubishi Configuration Parameters Dialog Box

**Serial port** specifies which COM port the object uses for communicating to the external device. This does not specify the communication type. Communication type is determined by the **Options»Serial Ports...** command.

**Data rate** indicates the baud rate that Lookout uses to communicate with the hardware device. This **Data rate** setting should match the selection made on the physical device.

**Data bits** indicates the number of data bits that Lookout uses to communicate with the hardware device. This **Data bits** setting should match the selection made on the physical device.

**Stop bits** indicates the number of stop bits that Lookout uses to communicate with the hardware device. This **Stop bits** setting should match the selection made on the physical device.

**Parity** indicates the parity that Lookout uses to communicate with the hardware device. This **Parity** setting should match the selection made on the physical device.

**Phone number** specifies the number to be dialed if the selected serial port is configured for dial-up. This **Phone number** only applies to the individual protocol object.

**PollRate** is a numeric expression that determines how often to poll the device. The object then polls the device at the specified time interval. Normally, this is a simple time constant such as 0:01 (one second). See *Numeric Data Members* in Chapter 2, *How Lookout Works*, of the *Getting Started with Lookout* manual for more information on entering time constants.

**Poll** is a logical expression. When this expression changes from FALSE to TRUE, Lookout polls the device. You can use a simple expression like the signal from a pushbutton, or a complex algorithm.

**Communication alarm priority** determines the priority level of alarms generated by the Mitsubishi object. Such alarms are typically related to communications with the physical device.

**Retry attempts** specifies the consecutive number of times Lookout attempts to establish communications with a device when it is not getting a valid response. After it tries the number of **Retry attempts** specified, the Mitsubishi object generates an alarm and releases the communication port back to the communications subsystem. The subsystem then moves on to the next device in the polling queue (if any). See Chapter 3, *Serial Port Communication Service*, in the *Lookout Developer's Manual* for more information.

**Receive timeout** is the time delay Lookout uses in waiting for a response from a device before retrying the request.

The **Skip every...** setting instructs Lookout not to poll a device it has lost communication with on every scheduled poll. Instead, Lookout skips the device in the polling cycle. Once communications have been reestablished, the device is polled on its regular cycle.

## Mitsubishi Data Members

As with all Lookout drivers, you can access I/O points and other data through data members. The following is a table of data members currently supported by the Mitsubishi object class.



**Note** The range of some data members may exceed what is available for your specific hardware. Be sure to use data members that correspond to the range that is implemented on your Mitsubishi hardware.

**Table 3-37.** Mitsubishi Data Members (A Series)

Data Member	Type	Read	Write	Description
C0–C255	numeric	yes	yes	Counter, 16-bit word.
CommFail	logical	yes	no	Object-generated signal, ON if Lookout cannot communicate with the device(s).
D0–D1023	numeric	yes	yes	Data register, 16-bit word.
M0–M2047	logical	yes	yes	Discrete coil, 1-bit.
Poll	logical	no	yes	When this expression transitions from FALSE to TRUE, Lookout polls the device.
PollRate	numeric	no	yes	Lookout expression that determines the device polling frequency.
T0–T255	numeric	yes	yes	Timer, 16-bit word.
Update	logical	yes	no	Object-generated signal that pulses low each time it polls the device.
W0–W1023	numeric	yes	yes	Data register, 16-bit word.
X0–X2047	logical	yes	no	Discrete input, 1-bit.
Y0–Y2047	logical	yes	yes	Discrete output, 1-bit.

**Table 3-38.** MitsubishiFX Data Members (FX Series)

Data member	Type	Read	Write	Description
C0–C255	numeric	yes	yes	Counter, 16-bit word.
CommFail	logical	yes	no	Object-generated signal that is ON if Lookout cannot communicate with the device(s).
D0–D2999	numeric	yes	yes	Data register, 16-bit word.
M0–M1535	logical	yes	yes	Discrete coil, 1-bit.
Poll	logical	no	yes	When this expression transitions from FALSE to TRUE, Lookout polls the device.
PollRate	numeric	no	yes	Lookout expression that determines the device polling frequency.
S0–S999	logical	yes	yes	State, 1-bit.
sD8000–sD8255	numeric	yes	yes	Special data register, 16-bit word.
sM0–sM255	logical	yes	yes	Special discrete coil, 1-bit.
T0–T255	numeric	yes	yes	Timer, 16-bit word.
Update	logical	yes	no	Object-generated signal that pulses low each time it polls the device.
X0–X377	logical	yes	no	Discrete input, 1-bit.
Y0–Y377	logical	yes	yes	Discrete output, 1-bit.

## Mitsubishi Status Messages

### No response within timeout period

Lookout received no response from a device within the **Receive timeout** period. The Mitsubishi object is able to use the COM port, but when it polls the device, it does not respond—as if it is not even there. If you have daisy-chained several devices, you have introduced an inherent delay. You may need to significantly increase **Receive timeout** (and **PollRate**) to ensure Lookout is allowing enough time to receive the expected response. This increase has nothing to do with the processing capabilities of Lookout, but is based solely on **Data rate** and the number of devices on the chain.

Also, verify your Baud rate settings, cable connections, power, configuration settings, COM port settings, and polling addresses.

**Incorrect frame check sum (FCS)**

The frame was received with an invalid frame check sum. Check for two or more devices with the same address.

**Incorrect PC number in response**

The frame received had an incorrect source address. Check for two or more devices with the same address.

**Incorrect command in response**

The frame received had an incorrect command. Check for two or more devices with the same address.

**Garbled or Invalid frame**

The frame was received without proper termination character (ETX). Check the Lookout **Receive Gap** setting.

**No acknowledgment for write frame**

The write frame was not acknowledged by the PC. Check the address of Mitsubishi object or the address range of the PC.

**Mitsubishi errors reported in the response**

These errors are reported by the Mitsubishi device, and are in turn reported to the user in text form.

## Mitsubishi Models Supported

A series:

A0J2, A0J2H, A1, A1S, A1N, A1E, A2, A2n, A2C, A2E, A3, A3N, A3E, A3H, A3M.

FX series:

All models through March, 1997.

## Mitsubishi CLM

This driver object communicates serially with Mitsubishi A Series PLCs using the A1SJ71UC24-R2 communications module, generally called Computer Link Module (CLM).

Use **Address** to specify the device number of the Mitsubishi PLC to control. Specify the A-series model number of the PLC using the **PLC Model** selection box.

**Serial port** specifies which COM port on the host computer that Lookout object uses for communicating to the external device. This does not specify the communication type. Communication type is determined by the **Options»Serial Ports** command. See Chapter 3, *Serial Port Communication Service*, of the *Lookout Developer's Manual* for more information on configuring serial ports for use with Lookout.

**Baud rate**, **Parity**, **Data bits**, and **Stop bits** reference the settings on the hardware device.

**Phone number** specifies the number dialed if the selected serial port is configured for dial-up. This **Phone number** only applies to the individual Mitsubishi object.

**PollRate** is a numeric expression that determines how often to poll the device. Lookout polls the device at the specified time interval. Normally, this is a simple time constant such as 0:01 (one second). See *Numeric Data*



Members in Chapter 2, *How Lookout Works*, of the *Getting Started with Lookout* manual for information on entering time constants.

**Poll** is a logical expression. When this expression changes from false to true, Lookout polls the device. Use a simple expression like the signal from a pushbutton, or a complex algorithm.

**Communication alarm priority** determines the priority level of the alarms generated by this object.

**Retry attempts** specifies the consecutive number of times Lookout attempts to establish communications with a device if it is not getting a valid response. After the specified number of **Retry attempts**, the object generates an alarm and begins to **Skip every  $n$  poll requests after comm failure**. Once Lookout reestablishes communication, it polls the device on the cycle defined by **PollRate**.

**Receive timeout** is the time delay that Lookout waits for a response from a device before retrying the poll request.

## Mitsubishi CLM Device Configuration and Equipment

Use a null-modem serial port cable, or a null modem adapter to communicate with the Mitsubishi CLM.

Make the following physical setting on the Mitsubishi CLM hardware for the Lookout Mitsubishi CLM object to function properly with the hardware.

- The Lookout Mitsubishi CLM object only uses control format 1. Set the Mode switch on the CLM to 1.
- Match the dip-switch settings on the CLM for baud and parity to the Lookout Mitsubishi CLM object settings.
- Set the hardware dip-switch to enable checksum (sum check) to TRUE because the Lookout Mitsubishi CLM driver implements checksum.

## Mitsubishi CLM Data Members

Some data members that are HEX addresses in the PLC are addressed as decimals in Lookout. For example, to use register D1F on the PLC, use the D31 data member. Convert from hexadecimal to decimal where necessary when using these data members.

**Table 3-39.** Mitsubishi CLM Data Members

<b>Data Member</b>	<b>Type</b>	<b>Read</b>	<b>Write</b>	<b>Description</b>
B0 – B1023	logical	yes	yes	link relay B.
CC0 – CC255	logical	yes	yes	Counter (coil) C.
CN0 – CN255	numeric	yes	yes	Counter (present value) C.
CommFail	logical	yes	no	Object-generated signal that is on if Lookout cannot communicate with the device.
CS0 – CS255	logical	yes	yes	Counter (contact) C.
D0 – D8191	numeric	yes	yes	Data register D.
F0 – F255	logical	yes	yes	Annunciator M.
L0 – L2047	logical	yes	yes	Latch relay L.
M0 - M8191	logical	yes	yes	Internal relay M.
Poll	logical	no	yes	When this value transitions from FALSE to TRUE, Lookout polls the device.
PollRate	numeric	no	yes	Lookout expression that determines the device polling frequency.
R0 – R8191	numeric	yes	yes	File register D.
S0 – S8191	logical	yes	yes	Step relay S.
SD0 – SD8191	numeric	yes	yes	Signed data register.
SRD9000 – SRD9255	numeric	yes	yes	Special register D.
SRM9000 – SRM9255	logical	yes	yes	Special relay M.
TC0 – TC255	logical	yes	yes	Timer (coil) T.
TN0 – TN255	numeric	yes	yes	Timer (present value) T.
TS0 – TS255	logical	yes	yes	Timer (contact) T.
Update	logical	yes	no	Object-generated signal that pulses low each time it polls the device.
W0 – W1023	numeric	yes	yes	Link register D.

**Table 3-39.** Mitsubishi CLM Data Members

Data Member	Type	Read	Write	Description
X0 – X2047	logical	yes	no	Discrete inputs.
Y0 – Y2047	logical	yes	yes	Discrete outputs.

## Mitsubishi CLM Status Messages

The following errors are generated by Lookout. Lookout also passes Mitsubishi errors to the Lookout Alarm window. For information on Mitsubishi errors, consult the *Computer Link Modules* manual for MitsubishiA/AnS Series PLCs.

### No response within timeout period

Lookout did not receive a response from the device within the **Receive timeout** period. The object was able to establish a connection, but the device did not respond to the sent message. Significantly increase **Receive timeout** and **Poll Rate** to ensure that Lookout allows enough time to receive the expected response. Also, verify cable connections, making sure you are using a null modem serial cable, or a null modem adapter on your cable, serial port wiring, power supply, and configuration settings.

### Unexpected frame length

The response from the PLC had the wrong number of bytes to be a valid response. Make sure the CLM module works with the PLC programming software.

### STX not detected from PLC

The Start of Text byte was not received from the PLC. Make sure the CLM module works with the PLC programming software. Also, verify cable connections, making sure you are using a null modem serial cable, or a null modem adapter on your cable, serial port wiring, power supply, and configuration settings.

If this does not fix the problem, significantly increase **Receive timeout** and **Poll Rate** to ensure Lookout is allowing enough time to receive the expected response.

### Invalid protocol information in response (no ETX)

No End of Text byte received from the PLC. Make sure the CLM module works with the PLC programming software. Also, verify cable connections, making sure you are using a null modem serial cable, or a null

modem adapter on your cable, serial port wiring, power supply, and configuration settings, and so on.

If this does not fix the problem, you may have to significantly increase **Receive timeout** and **Poll Rate** to ensure Lookout is allowing enough time to receive the expected response.

#### **Incorrect frame check sum (FCS)**

The check sum received from the PLC was not correct. Make sure you have enabled the check sum dip-switch on the CLM module.

## **Mitsubishi Models Supported**

A series: A0J2, A0J2H, A1, A1S, A1N, A1E, A2, A2AS, A2n, A2C, A2E, A3, A3N, A3E, A3H, A3M.

# Modbus

## ModbusMOSCAD

---

Modbus and ModbusMOSCAD are protocol driver classes Lookout uses to communicate with equipment such as programmable logic controllers (PLCs), remote terminal units (RTUs), or any other piece of equipment using Modbus Serial (ASCII or RTU) or Modbus Plus communication protocol.

The Modbus object class has general-purpose addresses, such as holding register 40001, and is suitable for communicating with nearly all Modbus devices, including the Control Microsystems TeleSAFE RTU.

The ModbusMOSCAD object class works with Motorola MOSCAD PLCs and RTUs. It also uses the Modbus Serial (ASCII or RTU) or Modbus Plus communication protocol, but its data members reflect the address of Motorola MOSCAD devices.

You can limit the number of channels Lookout uses on the SA-85 card by creating a `modbus.ini` file in the Lookout directory, as shown in the following example.

```
[ALL]
MaxChannels=channel
```

where *channel* is a number between 1 and 8, inclusive (default = 8).

These protocol driver objects contain a great deal of data. All readable and writable members (inputs/outputs), polling instructions, read/write blocking, serial port usage, and so on are bundled with the object.

Therefore, as soon as you create a Modbus or ModbusMOSCAD object you immediately have access to all the object data members (see data member list in Table 3-41).



**Note** Lookout protocol driver objects automatically generate an efficient read/write blocking scheme based on the inputs and outputs being used in your process file. You are not required to build your own I/O blocking table.

As protocol drivers, both object classes conform to the specifications in the Modicon Modbus Protocol Reference Guide PI-MBUS-300 Rev. C. The drivers support ASCII and RTU transmission modes, as well as Modbus Plus.

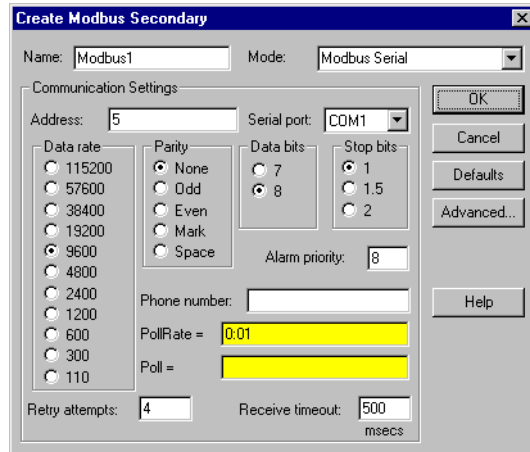

**Figure 3-17.** Modbus Configuration Parameters Dialog Box

In this example, Lookout is connected to a Modbus-speaking PLC with an address of 5 using serial port 1 (which was previously configured for hardwired communications), and polling the device every second.

**Modbus Serial** indicates that the slave device talks either Modbus ASCII or Modbus RTU. When you select this option, Lookout first tries to communicate using the RTU format. If unsuccessful, it then tries the ASCII format (a little slower). If your network is susceptible to repeated communication problems, and if these problems slow scanning considerably, you may want to disable Lookout from retrying both formats. This can speed communication retries by Lookout; however, it will not fix your communication problems. Call National Instruments technical support to for information on how to prohibit Lookout from trying to communicate using both formats.

**Modbus Plus Network** indicates that the slave device is connected to the Lookout computer via a Modbus Plus network card.



**Note** NetBIOS-based networking software typically uses software interrupt 5C. This is also the default software interrupt used by the Modbus Plus Network card driver. Change the Modbus Plus software interrupt from 5C to 5D, 5E, or 5F. Refer to your Modicon documentation for instructions on changing the software interrupt setting.

**Modbus Ethernet** indicates you are communicating with the Modbus slave device using an Ethernet connection.

If you select **Modbus Serial**, you must specify **Address**, **Serial Port**, **Data Rate**, **Parity**, **Data Bits**, and **Stop Bits**. And if you are using a Dial-up modem connected to your communication port, you must also specify a **Phone Number**.

If you select **Modbus Plus Network**, you need only specify the remote device **Address**.

If you select **Modbus Ethernet** you must specify the **IP address** in addition to **Alarm Priority**, **Poll Rate**, **Poll Retry attempts**, and **Receive timeout**.

**Address** is a slave address and refers to the PLC or RTU address setting as set on the device dip switches. If devices share a common line, they require unique addresses (1 to 255).

**IP address** is the Internet Protocol address for the Modbus slave object you are communicating with.

**Unit identifier** is used to distinguish between a device address and an IP address.

**Serial port** specifies which port the object uses for communication to the external device. This does not specify the communication type. Communication type is determined by the **Options»Serial Ports...** command.

**Data rate**, **Parity**, **Data bits**, and **Stop bits** reference the settings on the hardware device.

The **Defaults** button replaces the current settings with default values.

**Alarm priority** determines the priority level of Modbus-generated alarms.

**Phone number** specifies the number to be dialed if the serial port setting is configured for dial-up. This number only applies to the individual protocol object.

**PollRate** is a numeric expression that determines how often to poll the device. Modbus then polls the device at the specified time interval. Normally, this is a simple time constant such as 0:01 (one second). See *Numeric Data Members* in Chapter 2, *How Lookout Works*, of the *Getting Started with Lookout* manual for information on entering time constants.

**Poll** is a logical expression. When this expression changes from FALSE to TRUE, Lookout polls the device. You can use a simple expression like the signal from a pushbutton, or a complex algorithm.

**Retry attempts** specifies the consecutive number of times Lookout attempts to establish communications with a device if it is not getting a valid response. After it tries the number of **Retry attempts** specified, the Modbus object generates an alarm and releases the communication port back to the communications subsystem which then moves on to the next device in the polling queue (if any). Refer to Chapter 3, *Serial Port Communication Service*, in the *Lookout Developer's Manual* for more information.

**Receive timeout** is the time delay Lookout uses in waiting for a response from a device before retrying the request.

## Advanced Modbus Parameters

The Modbus driver attempts to block the reads and writes of coils, input registers and holding registers into groups to maximize communication efficiency. Through the **Advanced Modbus Options** dialog box, you can control the maximum block sizes that the driver uses. In fact, if your device does not support the default block sizes, you may have to specify smaller blocks.

The **Advanced...** button invokes the **Advanced Modbus Options** dialog box you can use to customize specific options within the Modbus protocol.



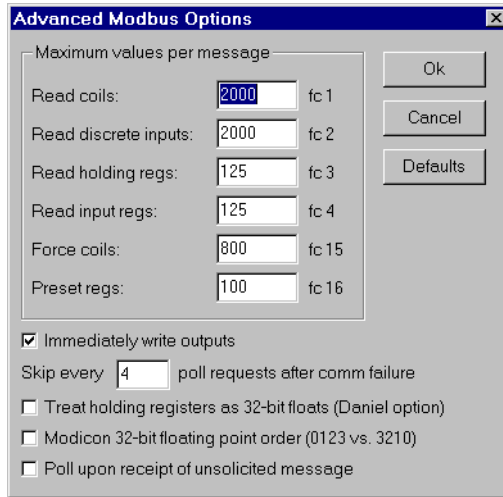

**Figure 3-18.** Advanced Modbus Parameters Dialog Box

The Modbus object class uses Modbus Function Codes 01, 02, 03, 04, 05, 06, 15, and 16; and expects the remote I/O device to support these codes as specified by Modbus. The driver can communicate with up to 247 Modbus slave devices on each serial port.

The **Maximum values per message** settings specify the maximum number of elements Lookout attempts to read (fc 1 – fc 4), or write (fc 15 and fc 16), in a single Modbus message. The default values represent the maximum number of elements that the protocol can transmit in a single message, and provides optimal speed. However, some devices are not capable of handling the maximum number of elements, so you should set the values according to the documentation for those devices.

If the **Immediately write outputs** option is ON, Lookout immediately polls the device any time a value changes that is being written out to the device. If it is OFF, Lookout waits until the next scheduled poll to write out changed values.

The **Skip every...** setting instructs Lookout to not poll a device it has lost communication with on every scheduled poll. Instead, Lookout skips the device in the polling cycle accordingly. Once communications have been reestablished, the device is polled on its regular cycle.

The **Daniel option** is device-dependent and instructs Lookout to treat holding registers as 32-bit IEEE floating values instead of 16-bit values. If you set this flag, you must also set your hardware device to treat holding

registers as 32-bit floats—most devices do not support this option, but Bristol-Babcock RTUs and Daniel flow meters do.



**Note** Activating the Daniel option deactivates all Modbus holding register members (on that device) except for 40001 – 49999 and 4000001 – 465000. If you attempt to read D40001, for example, the returned value is 0, and Lookout will not attempt to write D40001 to the RTU. Of course, in devices that do not support this option, you can still read and write two adjacent holding registers as a floating point value with the Modbus data members F40001 – F4999. In fact, this is a more general purpose solution than the Daniel option, because you can still read bits and word values out of the holding registers, too.

Some Modbus PLCs reverse byte order in a floating point data member. If your process is returning garbled or senseless floating point values, select the **Modicon 32-bit floating point order (0123 vs. 3210)** option in the **Advanced Modbus Options** dialog box. This option chooses whether the characters within the floating point registers (data members F40001 – F49999 and F400001 – F465000) are in little endian or big endian format.

On occasion a Modbus PLC will direct a message to your process. To poll for all data member values following receipt of such a poll, select the **Poll on receipt of unsolicited message** option in the **Advanced Modbus Options** dialog box. Using this option is a way to force a poll of a Modbus device based on an event, without reference to the configured poll intervals and somewhat outside the usual Lookout event-driven action.



**Caution** Notice that the D and F data members read two adjacent registers as single, 32-bit numbers. One consequence of this is that if you connect to two adjacent registers, such as D40010 and D40011, you will get incorrect values because of overlapping. Make sure that you do not connect to adjacent registers with the D or F data members.

## Modbus Protocol Statistics

The driver monitors Modbus Protocol Statistics. This data is held within readable data members of the Modbus object and you can see them in the Modbus Protocol Statistics dialog box. To view the dialog box, select **Options»Modbus...** and click on **Statistics...**



**Note** The **Options»Modbus...** option is only visible in the **Options** menu if a Modbus object was previously created in your Lookout application.

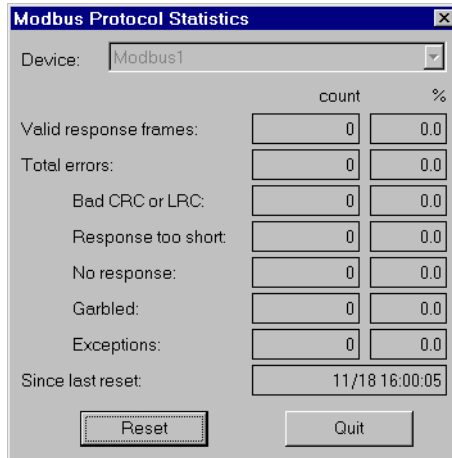

The dialog box titled "Modbus Protocol Statistics" shows a dropdown menu for "Device" set to "Modbus1". Below this is a table with two columns: "count" and "%". The table lists several categories with their respective counts and percentages, all of which are currently zero. At the bottom, there is a "Since last reset" field showing the date and time "11/18 16:00:05", and two buttons: "Reset" and "Quit".

	count	%
Valid response frames:	0	0.0
Total errors:	0	0.0
Bad CRC or LRC:	0	0.0
Response too short:	0	0.0
No response:	0	0.0
Garbled:	0	0.0
Exceptions:	0	0.0
Since last reset:	11/18 16:00:05	

**Figure 3-19.** Modbus Protocol Statistics Dialog Box

The **Count** column contains the accumulated number of messages received from the selected **Device** that fall into each respective category since the last time the Reset button was pressed. The percent column (%) indicates the percentage of messages received that fall into each respective category since the last time the Reset button was pressed.

When you depress the **Reset** button, the **ResetCounts** data member is set TRUE, setting all statistical values to zero. Lookout records the date and time that the reset was last performed in the **Since last reset** data field.

## Modbus Data Members

The Modbus object class supports both 5-digit and 6-digit addressing. When you use a 6 digit address, the left-most digit represents the address *type* as follows:

**Table 3-40.** 6-Digit Address Coding

First Digit	Address Type
0	Single-bit coils
1	Discrete inputs
3	Input registers
4	Holding registers

The remaining 5 digits represent the actual address of the coil, input or holding register.



**Note** When you reference address 000001 and address 1, you are referring to the same point, but 40001 and 040001 do not refer to the same point. Because zero is the left-most digit in the 6-digit address, 040001 points to the 40001<sup>st</sup> single-bit coil and 40001 refers to the first holding register.

**Table 3-41.** Modbus Data Members

Data Member	Type	Read	Write	Description
000001 – 065000	logical	yes	yes	6-digit addresses of single-bit coils
1 – 9999	logical	yes	yes	Single-bit coils
100001 – 165000	logical	yes	no	6-digit addresses of single-bit discrete inputs
10001 – 19999	logical	yes	no	Single bit discrete inputs
300001 – 365000	numeric	yes	no	6-digit addresses of 16-bit input registers encoded as unsigned binary integers ranging from 0 to 65535
30001 – 39999	numeric	yes	no	16-bit input registers encoded as unsigned binary integers ranging from 0 to 65535

**Table 3-41.** Modbus Data Members (Continued)

<b>Data Member</b>	<b>Type</b>	<b>Read</b>	<b>Write</b>	<b>Description</b>
400001 – 465000	numeric	yes	yes	6-digit addresses of 16-bit input registers encoded as unsigned binary integers ranging from 0 to 65535
400001.1 – 465000.16	logical	yes	yes	6-digit address used to access individual bits out of holding registers and read them as logical ON/OFF values. The least significant bit is 1; the most significant, 16.
40001 – 49999	numeric	yes	yes	16-bit holding registers encoded as unsigned binary integers ranging from 0 to 65535
40001.1 – 49999.16	logical	yes	yes	Access individual bits out of holding registers and read them as logical ON/OFF values. The least significant bit is 1; the most significant, 16.
BadCRC	numeric	yes	no	Number of responses from device whose message failed the cyclic redundancy check (CRC) or the longitudinal redundancy check (LRC)
BCD300001 – BCD365000	numeric	yes	no	6-digit addresses of 16-bit input registers encoded as binary-coded decimal integers ranging from 0 to 9999
BCD30001 – BCD39999	numeric	yes	no	16-bit input registers encoded as binary-coded decimal integers ranging from 0 to 9999
BCD400001 – BCD465000	numeric	yes	yes	6-digit addresses of 16-bit holding registers encoded as binary-coded decimal integers ranging from 0 to 9999
BCD40001 – BCD49999	numeric	yes	yes	16-bit holding registers encoded as binary-coded decimal integers ranging from 0 to 9999

**Table 3-41.** Modbus Data Members (Continued)

<b>Data Member</b>	<b>Type</b>	<b>Read</b>	<b>Write</b>	<b>Description</b>
CommFail	logical	yes	no	Driver-generated signal that is ON if Lookout cannot communicate with the device for whatever reason
D400001 – D465000	numeric	yes	yes	6-digit addresses of 32-bit unsigned holding register—reads two adjacent holding registers as a single 32-bit number ranging from 0 to 4,294,967,296.
D40001 – D49999	numeric	yes	yes	32-bit unsigned holding register—reads two adjacent holding registers as a single 32-bit number ranging from 0 to 4,294,967,296.
Exceptions	numeric	yes	no	Number of responses from device whose message was understandable to the driver but included an error code indication from the device
F400001 – F465000	numeric	yes	yes	6-digit addresses of 32-bit IEEE floating point register—reads two adjacent holding registers as a single 32-bit floating point value
F40001 – F49999	numeric	yes	yes	32-bit IEEE floating point register—reads two adjacent holding registers as a single 32-bit floating point value
Garbled	numeric	yes	no	Number of responses from device whose message was unintelligible to the driver
NoResponse	numeric	yes	no	Number of polls generated by driver not responded to by device
OffHook	logical	no	yes	When TRUE, this flag instructs the Modbus object to retain exclusive use of its assigned communication port
Poll	logical	no	yes	When this expression transitions from FALSE to TRUE, Lookout polls the device.

**Table 3-41.** Modbus Data Members (Continued)

<b>Data Member</b>	<b>Type</b>	<b>Read</b>	<b>Write</b>	<b>Description</b>
PollRate	numeric	no	yes	Lookout expression that determines the device polling frequency.
ProtocolErrors	numeric	yes	no	Total number of bad messages received from polled device
ResetCounts	logical	no	yes	Resets number to zero in the following data members: ValidFrame, NoResponse, TooShort, BadCRC, Garbled, Exceptions, & ProtocolErrors
S400001 – S465000	numeric	yes	yes	6-digit addresses of 16-bit holding registers encoded as signed binary integers ranging from –32767 to +32768.
S40001 – S49999	numeric	yes	yes	16-bit holding registers encoded as signed binary integers ranging from –32767 to +32768.
TooShort	numeric	yes	no	Number of responses from device whose message length was too short
Update	logical	yes	no	Driver-generated signal that pulses each time the driver polls the device
ValidFrame	numeric	yes	no	Number of good messages received from polled device

**Comments** You can use the OffHook data member to enhance communications when using the Modbus object class with dial-up modems. When OffHook is TRUE and the serial port is connected to a dial-up modem, the Modbus object does not hang up the modem when the poll is complete. Rather, it keeps the phone off the hook, retaining exclusive use of the serial port. As long as OffHook is TRUE, the Modbus object continues to poll the same PLC without hanging up the modem.

As soon as OffHook goes FALSE, the object releases the serial port to the communications subsystem, which goes to the next poll request in the queue, if any. The object also releases the port if data communications are lost for any reason—such as if the PLC modem breaks the connection.

When using OffHook, consider defining the driver object **PollRate** to poll fast when OffHook is TRUE, and poll at its normal rate when OffHook is FALSE. You might tie a Switch object to the OffHook writable data member for this very purpose.

## ModbusMOSCAD Data Members

**Table 3-42.** ModbusMOSCAD Data Members

Data Member	Type	Read	Write	Description
AI0r0c0 – AI30r255c7	numeric	yes	no	Each address represents a 16-bit analog input encoded as an unsigned integer ranging from 0 to 65535
AO0r0c0 – AO30r255c7	numeric	yes	yes	Each address represents a 16-bit analog output encoded as an unsigned integer ranging from 0 to 65535
BadCRC	numeric	yes	no	Number of responses from device whose message failed the cyclic redundancy check (CRC) or the longitudinal redundancy check (LRC)
CommFail	logical	yes	no	Driver-generated signal that is ON if Lookout cannot communicate with the device for whatever reason
DI0r0c0.0 – DI30r255c7.15	logical	yes	no	Each address represents an individual discrete input read as a logical ON/OFF value. The least significant bit is 0; the most significant, 15.
DO0r0c0.0 – DO30r255c7.15	logical	no	yes	Each address represents an individual discrete output read as a logical ON/OFF value. The least significant bit is 0; the most significant, 15.
Exceptions	numeric	yes	no	Number of responses from device whose message was understandable to the driver but included an error code indication from the device
Garbled	numeric	yes	no	Number of responses from device whose message was unintelligible to the driver



**Table 3-42.** ModbusMOSCAD Data Members (Continued)

Data Member	Type	Read	Write	Description
NoResponse	numeric	yes	no	Number of polls generated by driver not responded to by device
Poll	logical	no	yes	When this expression transitions from FALSE to TRUE, Lookout polls the device.
PollRate	numeric	no	yes	Lookout expression that determines the device polling frequency.
ProtocolErrors	numeric	yes	no	Total number of bad messages received from polled device
ResetCounts	logical	no	yes	Resets number to zero in the following data members: ValidFrame, NoResponse, TooShort, BadCRC, Garbled, Exceptions, & ProtocolErrors
TooShort	numeric	yes	no	Number of responses from device whose message length was too short
Update	logical	yes	no	Driver-generated signal that pulses each time the driver polls the device
ValidFrame	numeric	yes	no	Number of good messages received from polled device

**Comments** To specify the address of an analog input located in row 22, column 1 of Table 12, you would enter AI12r22c1, where

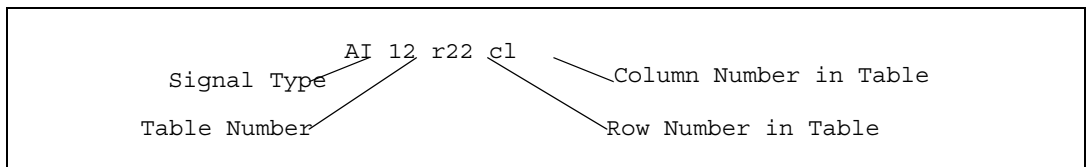

## Modbus Daniel

---

Use the Modbus Daniel Flow object to communicate with the Daniel Industries flow meter RTUs that use the Daniel Industries version of the Modbus protocol

**Address** is the PLC Modbus address.

**Serial port** specifies the COM port on the host computer that Lookout object uses for communicating to the external device. This does not specify the communication type. Communication type is determined by the **Options»Serial Ports** command. See Chapter 3, *Serial Port Communication Service*, of the *Lookout Developer's Manual* for more information on configuring your serial ports for use with Lookout.

**Data rate, Parity, Data bits, and Stop bits** reference the settings on the hardware device.

**Phone** specifies the telephone number dialed if the selected serial port is configured for dial-up. This number only applies to the individual protocol object.

**PollRate** is a numeric expression that determines how often to poll the device. Lookout polls the device at the specified time interval. Normally, this is a simple time constant such as 0:01 (one second). See *Numeric Data Members* in Chapter 2, *How Lookout Works*, of the *Getting Started with Lookout* manual for information on entering time constants.

**Poll** is a logical expression. When this expression changes from FALSE to TRUE, Lookout polls the device. Use a simple expression like the signal from a pushbutton, or a complex algorithm.

**Communication alarm priority** determines the priority level of the alarms generated by the Modbus Daniel Flow object.

**Retry attempts** specifies the consecutive number of times the object attempts to establish communication with a device if it is not getting a valid response. After the specified number of **Retry attempts**, the object generates an alarm and begins to **Skip every n poll requests after comm failure**. Once the object reestablishes communication, it polls the device on the cycle defined by **PollRate**.

**Receive timeout** is the time delay the object waits for a response from a device before retrying the poll request.

The **Skip every** setting instructs the object not to poll a device it has lost communication with on every scheduled poll. Instead, the object polls the device only once in the specified number of poll cycles. Once communication has been reestablished, the device is polled on the specified cycle.

Click the **Advanced** button to access advanced Modbus parameters. See the *Advanced Modbus Parameters* topic of the online Help or the *Advanced Modbus Parameters* section of this manual for information about setting the advanced Modbus parameters.

## Modbus Daniel Data Members

The following table lists the Modbus Daniel data members.

**Table 3-43.** Modbus Daniel Data Members

Data Member	Type	Read	Write	Description
CommFail	logical	yes	no	Object-generated signal that is ON if Lookout cannot communicate with the device.
OffHook	logical	no	yes	When TRUE, this flag instructs the Modbus Daniel Flow object to retain exclusive use of its assigned communication port.
Poll	logical	no	yes	When this value transitions from FALSE to TRUE, Lookout polls the device.
PollRate	numeric	no	yes	Lookout expression that determines the device polling frequency.
Update	logical	yes	no	Object-generated signal that pulses low each time it polls the device.
701.1.1-741.840.100	numeric	yes	no	Archive register stored as an array of IEEE floating point values within a record, and an array of these records within each register – addressed as <code>register.record.field</code> .
1001-3000	logical	yes	yes	Single-bit coils.

**Table 3-43.** Modbus Daniel Data Members (Continued)

<b>Data Member</b>	<b>Type</b>	<b>Read</b>	<b>Write</b>	<b>Description</b>
3001-5000	numeric	yes	yes	16-bit holding registers encoded as unsigned binary integers ranging from 0 to 65535.
5001-7000	numeric	yes	yes	32-bit holding registers encoded as unsigned binary integers ranging from 0 to 4,294,967,296.
7001-9000	numeric	yes	yes	32-bit holding registers encoded as IEEE floating point.
Bad CRC	numeric	yes	no	Number of responses from a device whose message failed the cyclic redundancy check (CRC) or the longitudinal redundancy check (LRC).
Exceptions	numeric	yes	no	Number of responses from a device whose message was understandable to the driver but included an error code indication from the device.
Garbled	numeric	yes	no	Number of responses from a device whose message was unclear to the driver.
NoResponse	numeric	yes	no	Number of polls generated by driver not responded to by device.
ProtocolErrors	numeric	yes	no	Total number of bad messages received from polled device.
ResetCounts	logical	no	yes	Resets number to zero in the following data members: ValidFrame, NoResponse, TooShort, BadCRC, Garbled, Exceptions, & ProtocolErrors.
TooShort	numeric	yes	no	Number of responses from device from which the message length was too short.
ValidFrames	numeric	yes	no	Number of good (valid) messages received from polled device.



# Modbus OmniFlow

Use the Modbus OmniFlow to communicate with the Omni 6000/Omni 3000 Flow Computers (firmware Version 70+). This driver uses the Modbus communication protocol with a few device-specific modifications.

**Device Id** is the Modbus ID in the Flow Computer.

**Serial port** specifies which COM port on the host computer the Lookout object uses for communicating to the external device. This does not specify the communication type. Communication type is determined by the **Options»Serial Ports** command. See Chapter 3, *Serial Port Communication Service*, of the *Lookout Developer's Manual* for more information on configuring your serial ports for use with Lookout.

**Baud rate**, **Parity**, **Data bits**, and **Stop bits** reference the settings on the hardware device.

**Phone** specifies the telephone number dialed if the selected serial port is configured for dial-up. This number only applies to the individual protocol object.

The **Modicon Compatible** check box is disabled, so that the Lookout Modbus OmniFlow driver is always Modicon compatible. Make sure your hardware setting is also Modicon compatible.

**PollRate** is a numeric expression that determines how often to poll the device. Lookout polls the device at the specified time interval. Normally, this is a simple time constant such as 0:01 (one second). See *Numeric Data*

**Members** in Chapter 2, *How Lookout Works*, of the *Getting Started with Lookout* manual for information on entering time constants.

**Poll** is a logical expression. When this expression changes from FALSE to TRUE, Lookout polls the device. Use a simple expression like the signal from a pushbutton, or a complex algorithm.

**Communication alarm priority** determines the priority level of the alarms generated by the Modbus object.

**Retry attempts** specifies the consecutive number of times Lookout attempts to establish communications with a device if it is not getting a valid response. After the specified number of **Retry attempts**, the object generates an alarm and begins to **Skip every  $n$  poll requests after comm failure**. Once Lookout reestablishes communication, it polls the device on the cycle defined by **PollRate**.

**Receive timeout** is the time delay Lookout waits for a response from a device before retrying the poll request.

## Modbus OmniFlow Data Members

**Table 3-44.** Modbus OmniFlow Data Members

Data Member	Type	Read	Write	Description
1001 – 1099	logical	yes	yes	Status and Command.
1101 – 1499	logical	yes	no	Status.
13001 – 13999	numeric	yes	yes	16-bit integer register.
F15001 – F15299	numeric	yes	yes	32-bit IEEE Floating Point.
1501 – 1799	logical	yes	yes	Status and Command.
F17001 - F18199	numeric	yes	yes	32-bit IEEE Floating Point.
1801 – 2699	logical	yes	no	Status.
2701 – 2799	logical	yes	yes	Status and Command.
2801 – 2999	logical	yes	no	Status.
3001 – 3999	numeric	yes	yes	16-bit integer register.
5001 – 5999	numeric	yes	yes	32-bit integer (2s complement).
F6001 – F8999	numeric	yes	yes	32-bit IEEE Floating Point.

**Table 3-44.** Modbus OmniFlow Data Members (Continued)

Data Member	Type	Read	Write	Description
CommFail	logical	yes	no	Object-generated signal that is on if Lookout cannot communicate with the device.
Poll	logical	no	yes	When this value transitions from FALSE to TRUE, Lookout polls the device.
PollRate	numeric	no	yes	Lookout expression that determines the device polling frequency.
Update	logical	yes	no	Object-generated signal that pulses low (FALSE) each time it polls the device.

## Modbus OmniFlow Status Messages

Modbus OmniFlow returns the following status messages.

### Invalid Address returned in frame

The address received in the reply from the PLC is not the same as the address sent in the request. This is normal if the PLC can not keep up with the requests sent by Lookout. A high Poll rate/slow device response are possible causes for this error.

### Invalid Function Code returned in frame

The command received in the reply from the PLC was not the same as the command sent in the request. This is normal if the PLC cannot keep up with the requests sent by Lookout. A high Poll rate/slow device response are possible causes for this error.

### Message Garbled - Bad CRC

The object receives a poll response from the device, but it can not decipher the response. Verify that all devices assigned to the device group have unique unit codes. The last part of the message may be getting cut off before it is completed. Increase the number of **Retry attempts**. Increase the Lookout serial port **Receive gap** setting to ensure that Lookout is receiving the entire message. Select **Options»Serial Ports** from the Lookout menu to check your serial port settings. If the serial port is configured for radio, this could be caused by an audible squelch tail occurring at the end of a radio transmission. Adjust **RTS delay off** and **CTS timeout**.



### **Unexpected data response length**

Check to see if the OmniFlow hardware is set for Modicon compatibility. At this time, Lookout requires Modicon compatibility to work with OmniFlow hardware.

### **No response from PLC**

Lookout did not receive a response from the device within the **Receive timeout** period. The object was able to establish a connection, but the device did not respond to the sent message. Significantly increase **Receive timeout** and **Poll Rate** to ensure that Lookout allows enough time to receive the response. Also, verify your cable connections, power, configuration settings, and IP settings.

### **Exception Response: Modbus Exception String**

This response is received when there is a MODBUS exception. The Exception string will specify what the exception is. This is directly from the MODBUS standard.

### **Unhandled Error**

Contact National Instruments technical support if you receive this error.

## ModbusSlave

---

ModbusSlave is an object class Lookout uses to act as a slave to equipment such as PLCs, distributed control systems (DCSs), or any other device that can act as a Modbus master. The ModbusSlave object enables Lookout to respond to unsolicited messages generated by other devices on a Modbus protocol network.

Applications include:

- PLCs and/or RTUs dial up a Lookout application over a non-dedicated phone line when there is an alarm or event that must be reported (unsolicited report-by-exception).
- Two Lookout packages communicate with each other over radio. One uses a Modbus object and the other uses a ModbusSlave object.
- Lookout, directly connected to a Modbus network, responds to polls from a DCS as a Modbus slave.

Think of the ModbusSlave object as representing a virtual PLC within Lookout. It can receive reads and writes over a Modbus protocol-based network. Like the Modbus object, the ModbusSlave object has a collection of readable and writable data members, all created when you define the ModbusSlave object.

You can create a unique ModbusSlave object for every master PLC, or you can create a single ModbusSlave object for multiple master PLCs. In the latter case, one master might write to one group of registers within the ModbusSlave object and another master might write to another group of registers within the ModbusSlave object.

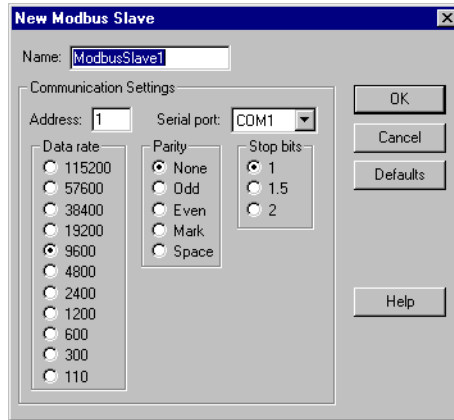

**Figure 3-20.** Modbus Slave Configuration Parameters Dialog Box

**Address** is a number (1 to 255) that refers to the address that this ModbusSlave object will assume. Even though this object exists only in software, other physical devices do not know that. They communicate with this object using a physical communication line and need to know the slave address.

**Serial port** identifies which communication port on the PC that the Modbus master uses to communicate with the ModbusSlave in Lookout.

**Data rate, Parity, Data bits, and Stop bits** reference the settings utilized by the master hardware device.

The **Defaults** button replaces the current settings with default values.

## Modbus Slave Data Members

**Table 3-45.** ModbusSlave Data Members

Data Member	Type	Read	Write	Description
1 – 9999	logical	yes	yes	Single-bit coils
10001 – 19999	logical	yes	yes	Single bit discrete inputs
30001 – 39999	numeric	yes	yes	16-bit input registers encoded as unsigned binary integers ranging from 0 to 65535

**Table 3-45.** ModbusSlave Data Members (Continued)

<b>Data Member</b>	<b>Type</b>	<b>Read</b>	<b>Write</b>	<b>Description</b>
40001 – 49999	numeric	yes	yes	16-bit holding registers encoded as unsigned binary integers ranging from 0 to 65535
BCD30001 – BCD39999	numeric	yes	yes	16-bit input registers encoded as binary-coded decimal integers ranging from 0 to 9999
BCD40001 – BCD49999	numeric	yes	yes	16-bit holding registers encoded as binary-coded decimal integers ranging from 0 to 9999
D30001 – D39999	numeric	yes	yes	32-bit input register
D40001 – D49999	numeric	yes	yes	32-bit unsigned holding register—reads two adjacent holding registers as a single 32-bit number ranging from 0 to 4,294,967,296.
F30001 – F39999	numeric	yes	yes	32-bit input register
F40001 – F49999	numeric	yes	yes	32-bit IEEE floating point register—reads two adjacent holding registers as a single 32-bit floating point value
H40001.f1 – H49999.f16	logical	yes	yes	Access individual bits out of holding registers and read them as logical ON/OFF values. The least significant bit is F1 and the most significant bit is F16.
S40001 – S49999	numeric	yes	yes	16-bit holding registers encoded as signed binary integers ranging from –32767 to +32768.

# NIDeviceNet

## NIDeviceNetExplicit

---

Use the NIDeviceNet driver to connect to specific DeviceNet devices through a National Instruments DeviceNet interface card. If you are handling ordinary I/O to a device, use this as the object.

Use the NIDeviceNetExplicit driver when you are using special commands unique to a particular DeviceNet device, as defined by the manufacturer of that device. This object requires you to be aware of DeviceNet protocol standards and the specific explicit messaging enabled by the device manufacturer.

Use one NIDeviceNet object with a large number of NIDeviceNetExplicit messaging objects for each device on a DeviceNet network.



**Tip** DeviceNet is a complicated protocol. Before using Lookout as your HMI/SCADA interface, make sure you are familiar with the hardware itself. Install the National Instruments DeviceNet card and use the accompanying DeviceNet card software to make sure the card is installed and working properly before you attempt to create and configure a DeviceNet object in Lookout. Consult the documentation supplied with your DeviceNet hardware for help in installing the card properly and testing it to make sure it is properly installed.

In addition to setting the basic parameters for your DeviceNet driver when you create a Lookout DeviceNet object, configure your National Instruments DeviceNet card. Access a dialog box for that purpose by clicking on the **Interface Configuration** button on the **Create NIDeviceNet** dialog box.

The first time you create a DeviceNet object (NIDeviceNet or NIDeviceNetExplicit), the **Interface Configuration** dialog box appears before the create object dialog box. After the first object, any time you create an object, the **Create NIDeviceNet** or **Create NIDeviceNetExplicit** dialog box will appear first. Click the **Interface Configuration** button to change which National Instruments DeviceNet interface card to use with that object.

For more information about configuring your National Instruments DeviceNet card for use with Lookout, see the [Configuring Your DeviceNet Card for Lookout](#) section.

It is possible that a DeviceNet network can enter a state when no communication is possible on the network. The only way to recover from this event is to use the **Test All** command from the Hardware Configuration Utility shipped with the National Instruments DeviceNet Interface Card. This performs a reset of the interface.

## NIDeviceNet Object Class

The following figure shows the **Create NIDeviceNet** dialog box.

**MAC ID** is the Media Access Control Identifier of the device you are communicating with through the DeviceNet interface card. The lower the number, the higher the priority of the device.

**Connection type** selects the connection between the interface card and the device. The connection types are `Poll`, `Cyclic`, `Strobe` or **Change Of State** (COS). Some DeviceNet devices require a specific connection type. Consult the device documentation to see what your particular devices require.



**Note** Use the `Simple Who` utility that ships with the National Instruments DeviceNet Interface card to determine what connection types are supported by a device.

If you choose `Strobe` as the Connection Type then the Expected Packet Rate (EPR) dialog is disabled. All devices with a `Strobe` connection on a particular Interface must have the same EPR. The EPR for the strobe connection can be changed from the Interface Configuration dialog box as detailed in the [Configuring Your DeviceNet Card for Lookout](#) section.

If you choose `COS` as the Connection Type, the `PollRate` field is disabled.

**I/O Input length** must match the configuration device. This value controls how many bytes your program reads from the device.

**I/O Output length** must match the device configuration. This value controls how many bytes your program writes to the device.



**Note** The value of I/O Input length and I/O Output length must be greater than or equal to 0, and less than or equal to 255.

**Expected Packet Rate** is the time in milliseconds between polls of a device by a DeviceNet interface card.

**Poll** is a logical expression. When this expression changes from FALSE to TRUE, Lookout polls the DeviceNet interface card for data from the specified device. Use a simple expression like the signal from a pushbutton, or a complex algorithm.

**PollRate** is a numeric expression that determines how often to poll a DeviceNet interface card. The object polls the card at the specified time interval. This is a simple time constant such as 0:01 (one second). See *Numeric Data Members* in Chapter 2, *How Lookout Works*, of the *Getting Started with Lookout* manual for information on entering time constants.

The **Skip *N* poll requests after Comm failure** setting instructs Lookout not to poll a device that it has lost communication with on every scheduled poll. Instead, Lookout skips the device in the polling cycle. Once communication has been reestablished, the device is polled on the specified cycle.

**Communication alarm priority** determines the priority level of alarms generated by the object. These alarms are typically related to communications with the physical device.

Clicking the **Interface Configuration** button activates the **DeviceNet Interface Configuration** dialog box, discussed on the [Configuring Your DeviceNet Card for Lookout](#) section. Use this dialog box to select which DeviceNet interface card installed in your computer for the DeviceNet object to communicate through, as well as to set the interface card's configuration.

## NIDeviceNetExplicit Object Class

The DeviceNet specification allows for a device manufacturer to use explicit messaging for special purposes in their devices, most often for configuration, or for non-standard devices. Use an NIDeviceNetExplicit object to use this feature.



**Note** Explicit messaging is an advanced feature of DeviceNet. Use this feature only if you are an experienced and advanced user of DeviceNet and if you're familiar with the manufacturer's implementation of explicit messaging on the particular device you intend to use this feature with.

**MAC ID** is the Media Access Control Identifier of the device you are communicating with through the DeviceNet interface card. The lower the number, the higher priority of the device.

Clicking the **Interface Configuration** button activates the **DeviceNet Interface Configuration** dialog box, discussed in the *Configuring Your DeviceNet Card for Lookout* section.

Explicit messaging for a given device uses three parameters to determine what message is being sent to which element of the device functionality. These three parameters are the service code, the class ID, and the instance ID.

Because the service code and the class ID rarely change, set these two parameters when creating an NIDeviceNetExplicit messaging object. Create a different object for each combination of settings you make in the **Service Code** and **Class ID** fields.

Use a number of different instance ID parameters with each service code and class ID combination, so this parameter is incorporated into the NIDeviceNetExplicit data members.

**Poll** is a logical expression. When this expression changes from FALSE to TRUE, Lookout polls the DeviceNet interface card for data from the specified device. Use a simple expression like the signal from a pushbutton, or a complex algorithm.

**PollRate** is a numeric expression that determines how often to poll your DeviceNet interface card. The object polls the card at the specified time interval. This is a simple time constant such as 0:01 (one second). See *Numeric Data Members* in Chapter 2, *How Lookout Works*, of the *Getting Started with Lookout* manual for information on entering time constants.



**Note** DeviceNet explicit messaging is not a true polled system. In this object, the **Poll** and **PollRate** parameters set how often the object sends out a message to get a response from each connection for a given object, not for all the data members possible with that object.

The **Skip N poll requests after comm failure** setting instructs Lookout not to poll a device that it has lost communication with on every scheduled poll. Instead, Lookout skips the device in the polling cycle. Once communications have been reestablished, the device is polled on the specified cycle.

**Communication alarm priority** determines the priority level of alarms generated by the object. These alarms are typically related to communication with the physical device.



## Configuring Your DeviceNet Card for Lookout

Before you can use the Lookout DeviceNet driver, configure the DeviceNet interface card using the Interface Configuration dialog box. Activate the **DeviceNet Interface Configuration** dialog box by clicking the **Interface Configuration** button in the **Create NIDeviceNet** dialog box.

If there is ongoing, active communication taking place through your DeviceNet interface card, all the parameters in the **Interface Configuration** dialog box are disabled. To stop communications, click the **Change Configuration** button. A dialog box appears to warn that the communication is in progress through the interface card and prompts you to confirm that you want to halt communications.

When you select **Change Configuration**, make sure that no other application is using the same interface card. For example, if you have a National Instruments LabVIEW application using the same interface card you are attempting to use with Lookout, a dialog box appears, warning that another application is using the selected card.

All of the parameters set in this dialog box are global to the interface card selected when you created the DeviceNet object. If you decide to use the same interface card with another instance of the DeviceNet object, or with an instance of the DeviceNetExplicit object, click the **Change Interface** button to change the parameters.

Every DeviceNet interface card has a unique interface name set by the Hardware Configuration Utility that is shipped with the card. **Interface Name** selects the name of DeviceNet interface card connected to the device you want to communicate with.

**MAC ID** is the ID number of the card on that particular DeviceNet network (0-63). The lower the MACID of a DeviceNet device, the higher priority it has in the network. Interface cards typically have the lowest numbers.

**Baud rate** sets the speed at which the interface card communicates with the network.

**Default Poll Mode** is the poll mode used by the interface card to talk to the network.

**Strobe EPR** is the rate at which a Strobe command is initiated by the interface card to the network.



**Note** Refer to the *NI-DNET User Manual* and the *NI-DNET Programmer Reference Manual*, shipped with National Instruments DeviceNet hardware, for more information about the NIDeviceNet parameters mentioned in the previous section.

## NIDeviceNet Data Members

**Table 3-46.** NIDeviceNet Data Members

Data Member	Type	Read	Write	Description
CommFail	logical	yes	no	Object-generated signal that is on if Lookout cannot communicate with DeviceNet.
DINT0-DINT252	numeric	yes	yes	32-bit signed integer.
UDINT0-UDINT252	numeric	yes	yes	32-bit unsigned integer.
INT0-INT254	numeric	yes	yes	16-bit signed integer.
LREAL0-LREAL248	numeric	yes	yes	64-bit floating point.
Poll	logical	no	yes	When this value transitions from FALSE to TRUE, Lookout polls the device.
PollRate	numeric	no	yes	Lookout expression that determines the device polling frequency.
REAL0-REAL252	numeric	yes	yes	32-bit floating point.
SINT0-SIN255	numeric	yes	yes	8-bit signed integer.
UINT0-UINT254	numeric	yes	yes	16-bit unsigned integer.
Update	logical	yes	no	Object-generated signal that pulses low each time it polls the device.
USINT0-USINT255	numeric	yes	yes	8-bit unsigned integer.
BOOL0.0 – BOOL255.7	logical	yes	yes	Specified as ByteOffset.Bit offset  Look at the logical value at the BitOffset in the specified in ByteOffset.
NIBBLE0 – NIBBLE511	numeric	yes	yes	Looks at the lower nibble of the byte at the offset.

**Table 3-46.** NIDeviceNet Data Members (Continued)

Data Member	Type	Read	Write	Description
UNIBBLE0 – UNIBBLE511	numeric	yes	yes	Looks at the upper nibble of the byte at the offset.
UNIBBLE0.0.- UNIBBLE511.3	logical	yes	yes	Looks at the logical value at the BitOffset in the specified NibbleOffset.

## NIDeviceNetExplicit Messaging Data Members

Each DeviceNet explicit message data member has two parts, the instance ID (`IID`) and the Data Type (`DINT`, `REAL`). Because one message may return several data responses, each with its own data type, be familiar with how the manufacturer of your device has implemented explicit messaging—including knowing the specific instance ID and data type requirements of the message you send, and the specific instance ID and data type of the response.

DeviceNet explicit messaging uses a large buffer to hold data. All I/O from a device uses that same, single buffer. The number after the data type specifies the data offset into that buffer.



**Tip** In order to read a DeviceNetExplicit data member write out a value first. Make write connections first before reading anything.

### Example

The task is to get attribute 1 from Class ID 1, Instance 3 of an object. Class ID 1 is the Identity Class, where all the identification information for the device is contained.

You will have already entered background information when you created the DeviceNetExplicit messaging object, setting the **Service Code** to 14 and the **Class ID** to 1. From the documentation provided by the device manufacturer, you know that `GetAttribute` only accepts an unsigned integer (`USINT`) as a parameter.

After creating the object, connect a pot to `IID3.USINT0` and set the pot value to 1 for the attribute data. Then read `IID3` using the data type that is returned in attribute 1.

The baud rate for the object in question is an 8-bit unsigned integer (`USINT`). To read the baud rate, access the `IID3.USINT0` data member.

**Table 3-47.** NIDeviceNetExplicit Messaging Data Members

<b>Data Member</b>	<b>Type</b>	<b>Read</b>	<b>Write</b>	<b>Description</b>
CommFail	logical	yes	no	Object-generated signal that is on if Lookout cannot communicate with DeviceNet.
IID0.DINT0-IID65535.DINT252	numeric	yes	yes	32-bit signed integer.
IID0.UDINT0-IID65535.UDINT252	numeric	yes	yes	32-bit unsigned integer.
IID0.INT0-IID65535.INT254	numeric	yes	yes	16-bit signed integer.
IID0.LREAL0-IID65535.LREAL248	numeric	yes	yes	64-bit floating point.
Poll	logical	no	yes	When this value transitions from FALSE to TRUE, Lookout polls the device.
PollRate	numeric	no	yes	Lookout expression that determines the device polling frequency.
IID0.REAL0-IID65535.REAL252	numeric	yes	yes	32-bit floating point.
IID0.SINT0-IID65535.SIN255	numeric	yes	yes	8-bit signed integer.
IID0.UINT0-IID65535.UINT254	numeric	yes	yes	16-bit unsigned integer.
Update	logical	yes	no	Object-generated signal that pulses low (FALSE) each time it polls the device.
IID0.USINT0-IID65535.USINT255	numeric	yes	yes	8-bit unsigned integer.

## DeviceNet Error Messages

The Lookout NIDeviceNet driver passes NI-DNET errors through to a program. For detailed explanations of error messages, refer to the NI-DNET documentation.

# National Instruments Fieldbus

---

Lookout can communicate with FOUNDATION Fieldbus devices using the National Instruments AT-FBUS or PCMCIA-FBUS fieldbus interface card.

The National Instruments Fieldbus object is available only when the AT-FBUS or PCMCIA-FBUS is installed. The object contains no inherent physical data members. All physical data members are obtained by reading the device description associated with the FOUNDATION Fieldbus device(s). A default Device Description that contains the standard function blocks is available for devices which do not have any manufacturer defined blocks. Lookout creates a Fieldbus object class dynamically for every uniquely named block found in any of the device descriptions. If a block is defined more than once by name, then the user is able select which device description block definition to apply to the Lookout object in the object creation dialog box.

In order to add or remove a Fieldbus block type to the Lookout object class list, delete the `Lookout.dat` file in the `\Lookout` directory and restart Lookout. This forces Lookout to re-index all of its subordinate object classes. When re-indexing occurs, Lookout looks into every device description in the directory system for Fieldbus blocks. The name of the Fieldbus object class corresponding to a particular block is the name of the block preceded by `FF_`. For example, the Lookout class name for the standard Analog Input block would be `FF_Analog_Input`.

Lookout also supports manufacturer supplied device descriptions. These device descriptions must be imported using the NI-FBUS Interface Configuration Utility. See the AT-FBUS or PCMCIA-FBUS documentation for more information about how to import manufacture-supplied device descriptions.



**Note** To work with Lookout, the manufacturer-supplied device description must have been created with tokenizer version 4.2 or later.

It is highly recommended that you review the documentation for the AT-FBUS or PCMCIA-FBUS interface card to learn about FOUNDATION Fieldbus basics and to ensure proper installation and configuration prior to beginning with the Lookout National Instruments Fieldbus object.

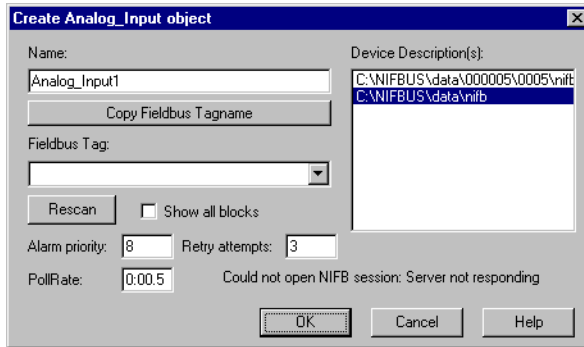

**Figure 3-21.** Fieldbus Configuration Parameters Dialog Box

To create an object from a device description other than the default, select the appropriate device description for the device from the list and click the **Rescan** button. Select the desired function block from the **Fieldbus Tag** pull-down menu. Clicking the **Copy Fieldbus Tagname** button will eliminate illegal characters from the object name and include naming information from the function block. Set the other parameters as desired and click on the OK button.

**Name** is the Lookout name and is used to reference this object in Lookout.

**Copy Fieldbus Name** replaces any invalid characters that may be in the Fieldbus Name with underscores while copying the Fieldbus Name into the Lookout Name edit box.

**Fieldbus Name** shows a list of all Fieldbus blocks, of the appropriate type, available on your network. This list comes from comparing the DD\_Item\_Type of the block on the networks with the type of object that the user has selected to create. If there are no devices in this listbox, you can click the **Show all blocks** checkbox and select the **Rescan** button to show Fieldbus blocks of all types on the network.



**Note** Lookout treats the block selected as the type of block the user was trying to make. If an incorrect block is selected, the wrong parameter list appears for that block and invalid data request may occur.

**Device Description** contains a list of Device Descriptions that have definitions for the block the user is about create. The parameter list for each definition may vary. Care should be taken in selecting the device description that corresponds with the device to be communicated with.

**PollRate** is a numeric expression that determines how often to poll the device. The object then polls the device at the specified time interval. Normally, this is a simple time constant such as 0:01 (one second). See *Numeric Data Members* in Chapter 2, *How Lookout Works*, of the *Getting Started with Lookout* manual for information on entering time constants.

**Retry** is the number of Fieldbus communication alarms to ignore before reporting an alarm.

**Alarm priority** determines the priority level of alarms generated by the National Instruments Fieldbus object. Such alarms are typically related to communications with the physical device.

## Fieldbus Alarms

The Fieldbus Alarms dialog box lets you acknowledge Fieldbus Alarms.

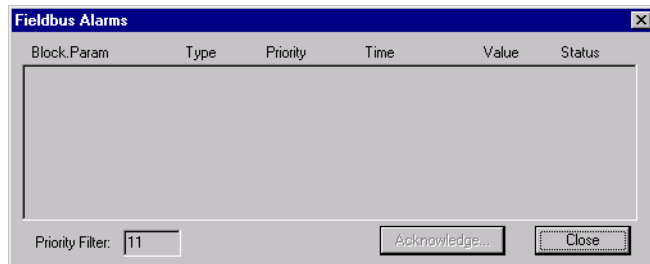

**Figure 3-22.** Fieldbus Alarms Dialog Box

**Priority Filter** filters alarms by priority. If you **Acknowledge** an alarm, it is removed from the list if successful.

## Fieldbus Data Members

As with all Lookout drivers, you can access I/O points and other data through data members. The following is a table of built-in data members currently supported by the National Instruments Fieldbus object class. All other data members are obtained from device descriptions.

**Table 3-48.** National Instruments Fieldbus Data Members

Data Member	Type	Read	Write	Description
Alarms	numeric	yes	no	Expression that shows number of active Fieldbus alarms.
CommFail	logical	yes	no	Object-generated signal that is on if Lookout cannot communicate with the device(s).
Poll	logical	no	yes	When this value transitions from FALSE to TRUE, Lookout polls the device.
ShowAlarms	logical	no	yes	When this value transitions from FALSE to TRUE, Lookout shows the Fieldbus alarm window.
Update	logical	yes	no	Object-generated signal that pulses low each time it polls the device.

## Fieldbus Status Messages

### No response within timeout period

Lookout did not receive a response from a device within the **Receive timeout** period. Check the device's connection. Check to see if the device can be polled using NI-FBUS Dialog.

### Cannot find nifb.dll

Lookout could not find a component needed to communicate with the Fieldbus devices. This component is placed during the installation of the NI-FBUS software. Make sure the installation was successful.

### Could not open NIFB session [: optional error message]

Lookout could not open a Fieldbus communications session. If available, specific error text is shown providing specific information. Make sure that the `nifb` driver in **Settings»Control Panels»Devices** is started. Also make sure that `nifb.exe` is running.

### Block name could not be found on network

Lookout could not find the block name specified on the Fieldbus network. Check name spelling or the device/network connections.



**I/O error: [error message]**

Lookout encountered an error during the read/write process. The error message, provided by the Fieldbus communication interface, contains specific information regarding the cause of the failure.

## Fieldbus Troubleshooting

**If after deleting the lookout.dat file and restarting Lookout there are no FF\_(Fieldbus Object) classes listed in Lookout; check the following:**

- Is the path to the base directory for manufacturer supplied device descriptions specified correctly in the NI-FBUS Configuration Utility under DD Info?
- Does the NI-FBUS Dialog application work correctly?

**Lookout cannot establish a fieldbus session with the card.**

- Is NIFB.EXE running?
- For Windows NT, has the device driver nifb been started by looking in Devices in the Windows NT Control Panel?
- Does the NI-FBUS Dialog application work correctly?

Refer to the AT-FBUS and PCMCIA-FBUS documentation for more troubleshooting information.

# National Instruments FieldPoint

FieldPoint is a protocol driver class Lookout uses to communicate with FieldPoint devices using an enhanced version of the Optomux communication protocol. Refer to the *Choosing a Method to Access FieldPoint* topic in the Lookout Help for more information about accessing FieldPoint in Lookout.

This protocol uses no parity, eight data bits and one stop bit. In Lookout, a single FieldPoint object represents all devices connected to the same COM port.

The Lookout FieldPoint object can read and write to all predefined data points allowed by the particular FieldPoint module. When you create a FieldPoint object, you have immediate access to all the object data members. See the *FieldPoint Data Members* section for more information on object data members.



**Note** Before attempting to use this object, you should install, configure, and test your FieldPoint modules using FieldPoint Explorer.

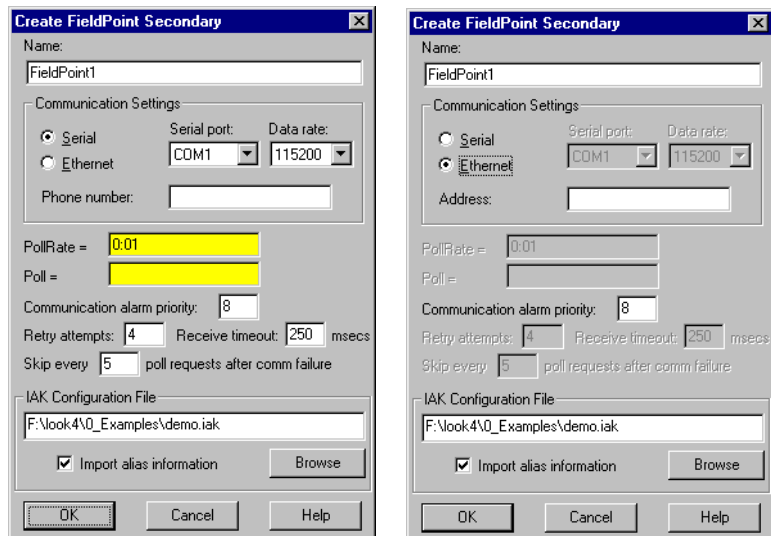

**Figure 3-23.** National Instruments FieldPoint Configuration Parameters Dialog Box

When you select the **Ethernet** option, the serial port configuration options are disabled.

Enter the IP address in the **Address** field. You could also enter the FieldPoint network name instead.



**Note** If you replace a FieldPoint FP-1000 module (serial communications) with a FieldPoint FP-1600 module (Ethernet communications) or replace an FP-1600 module with an FP-1000 module, you must re-import your .IAK file. First, you must use FieldPoint Explorer to update your .IAK file. If necessary, consult your FieldPoint online help for detailed instructions on using FieldPoint Explorer. To re-import the .IAK file, deselect the **Import alias information** checkbox and click on **OK**. Reopen the FieldPoint object dialog box and select the **Import alias information** checkbox again. When you click on **OK**, Lookout re-imports the new .IAK file information.

**Serial port** specifies which COM port the object uses for communicating to the external device. This does not specify the communication type. Communication type is determined by the **Options»Serial Ports...** menu command.

**Data rate** indicates the baud rate that Lookout uses to communicate with the hardware device. This setting should match the selection made on each of your network modules.

**Phone number** specifies the number to be dialed if the selected serial port is configured for dial-up. This number only applies to the individual protocol object.

**PollRate** is a numeric expression that determines how often to poll the device. The object then polls the device at the specified time interval. Ordinarily, this is a simple time constant such as 0:01 (one second). See *Numeric Data Members* in Chapter 2, *How Lookout Works*, of the *Getting Started with Lookout* manual for information on entering time constants.

**Poll** is a logical expression. When transitioned from FALSE to TRUE, Lookout polls the device. This can be a simple expression, like the signal from a pushbutton, or it can be a complex algorithm.

**Communication alarm priority** determines the priority level of alarms generated by the FieldPoint object. Such alarms are typically related to communications with the physical device.

**Retry attempts** specifies the consecutive number of times Lookout attempts to establish communications with a device if it is not getting a valid response. After it tries the number of **Retry attempts** specified, the FieldPoint object generates an alarm and releases the COM port. Refer to

Chapter 3, *Serial Port Communication Service*, in the *Lookout Developer's Manual* for more information.

**Receive timeout** is the time delay Lookout uses in waiting for a response from a device before retrying the request.

The **Skip every n** setting instructs Lookout to not poll a device it has lost communication with on every scheduled poll. Instead, Lookout skips the device in the polling cycle. Once communications have been reestablished, the device is polled on its regular cycle.

**IAK configuration file** is a dialog for selecting an IAK configuration file. The IAK file contains alias and scaling information which is extracted for use in Lookout. Choose the configuration file you want to use by entering the path directly, or use the **Browse** button. Check **Import alias information** if you want to extract information from the selected file.

## FieldPoint Filtering for Counter Overflow Alarms

Lookout 4.5 includes a modified version of the FieldPoint driver object class that can filter Counter overflow alarms.

To enable this capability you must make an entry in the `fpoinf.INI` file. The section name and entry are

```
[FieldPointTagName]           FilterChAlarms=1
```

A value of 1 (TRUE) filters the alarms. A value of 0 (FALSE) disables the alarms. If there is no entry (default), the alarms are not filtered.

Because you cannot filter only the Counter-overflow alarm, you must filter other alarms of the same type with this setting, as shown in the following table.

Module Name	[chnl_status] Value	Error Message
FP-AI-100	1	Out of range
FP-AI-110	1	Out of range
FP-AI-111	1	Out of range
FP-AO-200	1	Open Current Loop
FP-AO-210	1	Overcurrent Protection
FP-DO-410	1	Current Limited

Module Name	[chnl_status] Value	Error Message
FP-TC-120	1	Out of Range
FP-RTD-122	1	Out of Range
FP-CTR-500	1	Overflow since Last Read

All the above alarms will be filtered with through the .INI file setting. These are all basically the ChannelStatus 1 alarms. For more detailed information consult the *FieldPoint Programmer's Manual*.



**Note** Refer to the FieldPoint documentation for more information about FieldPoint module configuration.

## FieldPoint Data Members

As with all Lookout drivers, you can access I/O points and other data through data members. The following is a table of data members currently supported by the FieldPoint object class.

**Table 3-49.** National Instruments FieldPoint Data Members

Data Member	Type	Read	Write	Description
AI000.00 - AI255.15	numeric	yes	no	Analog input channels.
AO000.00 - AO255.15	numeric	yes	yes	Analog output channels.
CA000.00 - CA255.15	numeric	yes	no	Use to connect to count inputs on a FieldPoint counter module.
CD000.00 - CD255.15	logical	yes	no	Use to connect to digital inputs on a FieldPoint counter module.
CI000.00 - CI255.15	logical	no	yes	Counter increment.
CO000.00 - CO255.15	logical	yes	yes	Use to connect to digital outputs in a FieldPoint Counter module.
CommFail	logical	yes	no	Goes high if Lookout cannot communicate with the device.
CR000.00 - CR255.15	logical	no	yes	Counter reset.
DI000.00 - DI255.15	logical	yes	no	Discrete input channels.
DO000.00 - DO255.15	logical	yes	yes	Discrete output channels.

**Table 3-49.** National Instruments FieldPoint Data Members (Continued)

<b>Data Member</b>	<b>Type</b>	<b>Read</b>	<b>Write</b>	<b>Description</b>
Offhook	logical	no	yes	When TRUE, this flag instructs the object to retain exclusive use of its assigned communication port.
PF000.00 - PF255.15	numeric	yes	yes	Pulse width modulator period setting. Period is the entire on/off time of the pulse in milliseconds.
PhoneNumber	text	yes	yes	Phone number for dial-up use.
Poll	logical	no	yes	When transitioned from low to high, Lookout begins a poll cycle on the device.
PollRate	numeric	no	yes	Specifies the frequency at which Lookout polls the device.
PW000.00 - PW255.15	numeric	yes	yes	Sets the FieldPoint pulse module duty cycle on/off ratio. A setting of 10.00 means the pulse is on for 10% of the pulse period and off for 90%.
RL000.00 - RL255.15	logical	yes	yes	Use to connect to digital output channels on a FieldPoint relay module.
RT000.00 - RT255.15	numeric	yes	no	RTD temperature measurement module analog input; returns a value in degrees Centigrade.
TC000.00 - TC255.15	numeric	yes	no	Use to connect to analog input channels on a FieldPoint thermocouple module.
Update	logical	yes	no	Goes high when Lookout begins a poll cycle on the device.



**Note** When you use the CA, CD, CI, CO, CR, PW, RL, RT, and TC data members with FieldPoint serial modules, they are synonyms for analog or digital inputs or outputs as follows:

CI, CD—Digital Input  
 CR, CA, RL—Digital Output  
 PF, PP, RT, TC—Analog Input  
 PW—Analog Output

With FieldPoint Ethernet, these data members represent different FieldPoint modules.



**Note** The first two characters of the I/O data members represent the kind of module being accessed. The next three digits represent the device address of the module. This is the address of the I/O module itself, not the network module that governs it. Following the period are two digits representing the channel number within the module.

Not all of these data members are valid for every FieldPoint module. For all the device types you are able to select the full range of device addresses and channels. So if you select DO123.03, you need to be certain that the device at address 123 is in fact a discrete output module.

For a more complete definition of the function of these data members, see FieldPoint documentation.



**Note** In the event of a power cycle to the FieldPoint device during use, the configuration of the device reverts to some default state, which is configurable. You should keep in mind that if the ranges you configured into the IAK file differ from those in the power-up configuration, the scaling information imported from the IAK file and used as a Lookout alias might become outdated and incorrect after a power loss. To avoid this, make certain your power-up configuration ranges and your IAK configuration ranges are identical.

## FieldPoint Multiple Discrete Data Members

**Table 3-50.** Multiple Discrete Data Members

Data Member	Type	Read	Write	Description
MDI000.0000 - MDI255.FFFF	numeric	yes	no	Multiple discrete input channels
MDO000.0000 - MDO255.FFFF	numeric	yes	yes	Multiple discrete output channels

These special purpose data members are for reading or writing a numeric integer value to a set of discrete channels.

For instance, when you are configuring your modules with FieldPoint Explorer, you have the option of selecting more than one discrete channel for a data item that you are defining. If you do this and import the resulting .IAK file into Lookout for use as aliases, the aliases created will correspond to this set of data members. You can then read and write to all the discrete channels with a single numeric data member. The data member names are in the form MTTAAA.CCCC, where:

M	Indicates multiple as opposed to single
TT	Two characters specifying module type (Discrete Out, Discrete In)
AAA	Three numeric characters specifying module address
CCCC	Four hexadecimal characters specifying which of the 16 channels are included in this data member



**Note** These data members will not enumerate. You may use them either by importing configurations from FieldPoint Explorer or by entering the data member name explicitly.

## FieldPoint FPTB-10 Module Data Members

The following data members are for use with the FieldPoint FPTB-10 module. These data members appear in a FieldPoint object only if the FPTB-10 module is installed and configured as part of the FieldPoint hardware.

**Table 3-51.** FieldPoint TB-10 Module Data Members

Data Member	Type	Read	Write	Description
TBAI000.00 – TBAI255.15	numeric	yes	no	Analog input channels
TBAO000.00– TBAO255.15	numeric	yes	yes	Analog output channels
TBDI000.00 – TBDI255.15	logical	yes	no	Digital input channels
TBDO000.00– TBDO255.15	logical	yes	yes	Digital output channels



**Note** The first two characters of the I/O data members, TB, indicate that the module being accessed is an FPTB-10 module. An FPTB-10 module can have different channel types. The next two characters represent the type of channel being accessed, such as AI for Analog Input or DO for Discrete Output. The next three digits represent the device address



of the module. This is the address of the I/O module itself, not the network module that governs it. Following the period are two digits representing the channel number within the FPTB-10 module. If you select `TBDO4 . 03`, there is an FPB-10 module at position 4 and channel 3 is a Discrete Output. Similarly, `TBAO4 . 05` is an FPTB-10 module at position 4 and channel 5 is an Analog Output type.

## FieldPoint Error Messages

### No response within timeout period

Lookout received no response from a device within the **Receive timeout** period. The FieldPoint object is able to use the COM port, but when it polls the device, the device does not respond. If you have daisy-chained several devices, you have introduced an inherent delay. You may have to significantly increase **Receive timeout** (and **Poll Rate**) to ensure Lookout is allowing enough time to receive the expected response. This increase has nothing to do with the processing capabilities of Lookout. Rather it is based solely on **Data rate** and the number of devices on the chain. Also, verify your baud rate settings, cable connections, power, configuration settings, COM port settings, and polling addresses.

### Module returning ?? checksum

This means that the frame sent from the PLC in response to the command sent by Lookout out returned ?? instead of a valid checksum. Check FieldPoint configuration.

### Message Garbled - Bad CRC

This means the checksum (CRC in this case) failed in a frame received by Lookout. Check cabling or for two or more devices with the same address.

### Unexpected data response length

The frame received was of an unexpected length. Check the Lookout **receive gap** setting.

### Error loading IAK configuration file

Lookout was not able to successfully extract data from the `.IAK` configuration file. Try running the FieldPoint Explorer again and reconfigure your hardware.

### FP error: Power-up clear expected

A command other than power-up clear was attempted after power-up or power failure. The command sent is ignored and normal operations should resume.

**FP error: Undefined command**

The addressed module does not support this command. (for example, trying to write to an input module) Check to see if you are sending a command appropriate to the module.

**FP error: Checksum error**

This means the checksum (CRC in this case) failed in a frame sent by Lookout. Check the Lookout **receive gap** setting.

**FP error: Input buffer overrun**

The command sent to the FieldPoint module was too long. Check the Lookout **receive gap** setting.

**FP error: Non-printable ASCII character received**

Only characters from ASCII value 33 to 127 are permitted in FieldPoint commands. The command is ignored.

**FP error: Data field error**

An insufficient or incorrect number of characters were received by the FieldPoint module for the specified command. Check the Lookout **receive gap** setting.

**FP error: Communications link network watchdog timed out**

There has been no network traffic in the amount of time specified by your watchdog configuration settings, and the system has reverted to its watchdog defaults.

**FP error: Specified limits invalid for the command**

This includes the case where an invalid digit (hex or decimal) was received. Check the Lookout **receive gap** setting.

**FP error: ASCII to binary conversion error**

One or more ASCII characters could not be converted to binary on the FieldPoint module. Check the Lookout **receive gap** setting.

**FP error: Invalid device address**

The command is valid, but the addressed module does not support the command received. Check to see if you are sending a command appropriate to the module.

**FP error: Serial framing error**

An improperly framed command was received by the FieldPoint module. Check the Lookout **receive gap** setting.

**FP error: Addressed module does not exist**

Make sure that you are addressing a valid module address.

**FP error: Invalid channel**

One or more channels specified in the command either do not exist or do not support the operation specified.

**FP error: Invalid range setting**

Check to see that the range information on the module has not changed, possibly due to a loss of power.

**FP error: Invalid operation for the module**

One or more module-specific operations specified in the command either do not exist or do not support the operation specified. Make sure that you are not requesting a discrete operation for an analog module, and vice versa.

**FP error: Module has been hotswapped since last command**

The alarm should deactivate immediately after it appears. Its appearance is only to acknowledge that a hot swap has occurred.

**FP error: Irrecoverable hardware fault**

A malfunction in the FieldPoint firmware or hardware has made communications from Lookout impossible.

**Channel specific error: dev:##,ch:##,err:##**

These are error codes returned from the FieldPoint I/O modules. The alarm message specifies a device address, channel number, and error code. See FieldPoint documentation for a description of the error condition.

## National Instruments Lookout OPC Client

Lookout uses the National Instruments Lookout OPC client to read data from and write data to any OPC server. It supports numeric, logical (boolean), and text I/O. The Lookout 4 OPC client normally reads from the cache. You can connect a switch or pushbutton to the `PollDevice` data member to trigger a device update.

For your convenience, you can create `OPCFieldPoint` and `OPCNIDAQ` versions of the `OPCClient` object class by selecting these two special cases from the **Select Object Class** dialog box.



**Note** If you are using the National Instruments OPC IATest server, there is no device to poll. Triggering the `PollDevice` data member returns a zero (0). Simulated data will be restored shortly after such a poll.

The **Server Name** box enumerates all of the OPC servers registered on the local computer. Select the appropriate server.



**Note** The Server Name listbox contains only local servers. It has no effect on what you find when you browse remote servers.

You can then select one of the **In-Process Server**, **Local Server**, and **Remote Server** options. These options specify the type of server the OPC client will attempt to launch. If it cannot successfully connect to the selected server, the OPC client generates an alarm.

Select **Remote Server** to enable **Computer Name**, which specifies the name of the computer on which the remote server is to be launched. If you know the computer name you want, enter it preceded with two backslashes, as in \\PUMMEL.



**Caution** In-process servers should only be used if Lookout is the only program communicating with the server. If other programs address the same server, use the Local Server option.

The **Browsing** options include **Disabled**, **Flat**, and **Hierarchical**. If your OPC servers permit browsing, select either **Flat** or **Hierarchical**. If you enable flat browsing all data members appear in any Lookout windows displaying OPC client data members. If you select **Hierarchical**, the data members are arranged in hierarchical folders.

To browse remote servers, click on the browsing button next to the **Remote Server** field. The following dialog box appears.

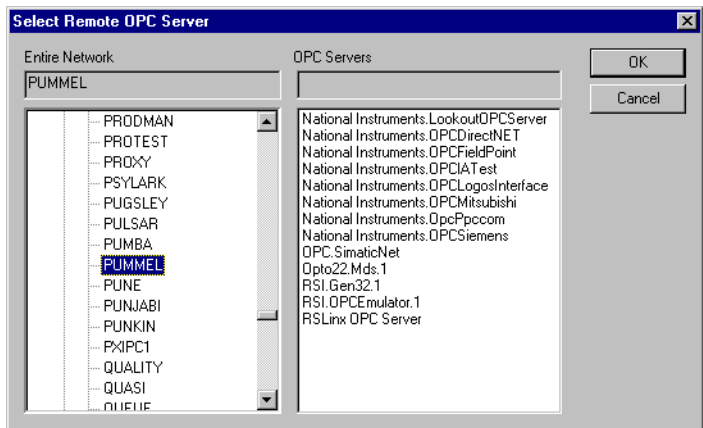

Browse for the computer you want, and select the OPC server running on the computer that you want to access.



**Note** You must have the Microsoft Remote Registry service installed for remote OPC browsing to work on a computer running Windows 98/95. To install, select **Start»Settings»Control Panel** and then select **Network**. Check the Configuration tab to

see if Microsoft Remote Registry is installed. If it is not, click on the **Add** button, and select **Service** in the **Select Network Component Type** dialog box. Choose Microsoft as the manufacturer. If the Remote Registry service is not visible, you will need your Windows 98/95 CD-ROM. You may have to browse through the disk to find the correct service. Once you have installed this service, you can successfully use remote OPC browsing in the Lookout OPCClient object.

Select **Use Asynchronous I/O** if you want to use asynchronous communications with your OPC server. This is the preferred communications mode, and should be used when possible.

The **Force Refresh after Write** option is only available if you select the **Use Asynchronous I/O** option. This option forces the OPC server to return the current status of all data members every time you write to one.



**Note** Selecting **Force Refresh after Write** can sometimes impair performance of your Lookout process, depending on the number of data members in your OPC server and other system variables, including communications speed and what other tasks are being performed at any particular moment.

**Update Rate** is a numeric expression that determines how often the OPC server updates the client. Enter this time interval in milliseconds.

**Deadband** sets the percentage change that must take place in a data member before the OPC server reports a change in value to Lookout.

**Poll Device** is a logical expression. When this expression changes from FALSE to TRUE, Lookout polls the OPC server for all values. You can use a simple expression like the signal from a pushbutton, or a complex algorithm. In most applications there is no need to do device reads, so this parameter is often left blank.

Enter a **Default Access Path** if you want to simplify entering paths to various data members.

**Communication Alarm Priority** specifies the priority of alarms generated by this OPC client object.

## Using OPC with Lookout

This section describes several issues you need to be aware of when using OPC with Lookout.

## OPCClient Performance

National Instruments recommends that you use the OPCClient object to communicate with National Instruments Data Acquisition, SCXI, and FieldPoint products when possible for performance reasons.

Also, you will increase performance when you use Lookout with the OPCClient on the same computer as the OPC server application you are exchanging data with. You can then use the TCP/IP-based networking built into Lookout to pass this data across the network to other Lookout clients and servers.

## Editing the OPCClient Database

When you open the OPCClient database to work with the OPC data members, you must manually set the data type for each data member when you select it. Lookout does not automatically set a data type for an OPCClient data member.

## Security and OPC Client/Server

When you disable task switching as a security option by selecting **User cannot switch to another program** in the **System Options** dialog box, you disable all top level windows. This can cause problems with OPC servers under Windows 95 when someone with a security level lower than the level you set logs in to Lookout.

To fix this problem, add the following lines to your `lookout.ini` file using any text editor:

```
[Security]
DisableWindows=0
```

This `.ini` file setting fixes the OPC problem, but it does mean that an operator can switch to other applications if he can click on their windows or on their icons in the task bar. To maintain security, make sure you select the **Lookout will always be maximized** option in the **System Options** dialog box, and make sure that your Windows taskbar (accessed by selecting **Start»Settings»Taskbar**) is set to **Auto hide**, and that **Always on top** is disabled.

For more information on the `lookout.ini` file, see Appendix C, *.INI File Settings for Lookout*, of the *Lookout Developer's Manual*.

## OPC Client Data Members

As with all Lookout drivers, you can access I/O points and other data through data members.

Unlike other Lookout driver objects, however, the OPCClient data member set changes depending on the OPC servers you have running on your computer.

If you selected hierarchical browsing when you created the OPCClient, the data members for the OPC server you have connected your OPC client to appear as data members inside a folder in your OPCClient list of data members in the Lookout Object Explorer, connection editor, and other windows as shown in the following illustration.

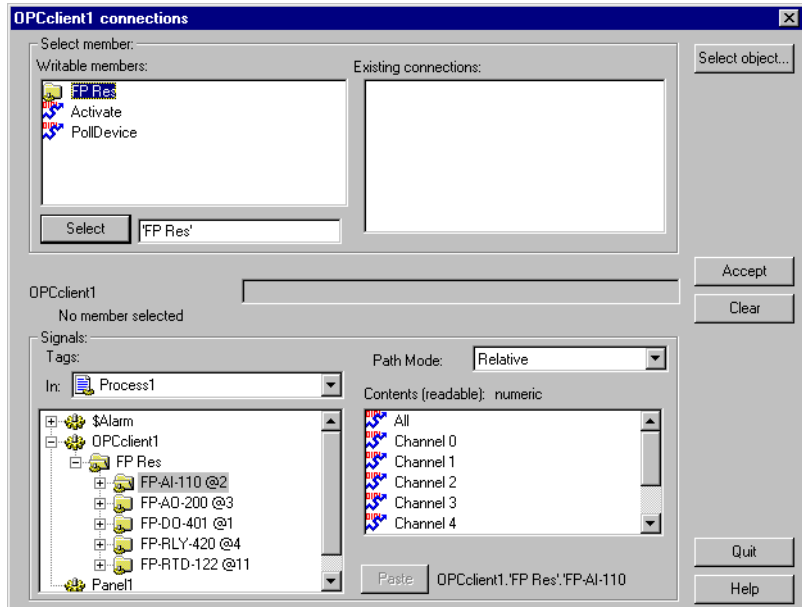

If you selected flat browsing, you will see a long list of available data members without hierarchical organization into folders.

If you did not enable browsing, or your computer cannot browse certain OPC servers, you will only see the data members built into the Lookout OPCClient.



The Lookout OPCClient object class currently contains the built-in data members contained in the following table.

**Table 3-52.** OPCClient Data Members

Data Member	Type	Read	Write	Description
Activate	logical	yes	yes	When TRUE, the OPC client is active and receives data. When FALSE, the OPC client does not update.
CommFail	logical	yes	no	Goes high if Lookout cannot communicate with the server.
DataError	logical	yes	no	Goes high if the object cannot properly process the data returned by the server.
PollDevice	logical	no	yes	When transitioned from FALSE to TRUE, the object polls the server.
Update	logical	yes	no	Pulses high and low when the OPC server updates Lookout or Lookout successfully polls the server.

The data members for the OPC Client depend on your OPC server. To use one of the data members from your server, enter the data member directly into an expression or URL field.

If the OPC server permits browsing, you can use data members as you would with any other Lookout driver object. If you cannot browse your OPC server, enter the item manually in the form acceptable to your OPC server, as in the following example:

```
OPCclient1.'device\folder\itemName'
```



**Note** Notice the use of single quotes. Using a single quote around a component of a path allows the use of any character in that path, not just the normally allowed characters.

If all your items use the same access path, use the **Default Access Path** option. If you need to specify a different access path, use a period and tilde (.~) to denote the first element of the path, as in the following example:

```
OPCclient1.'device\itemN'.'~accesspath'
```

Notice that the access path must be a separate component. Single quotes denote a string as being a single component.

If an item name or access path already contains a tilde, you must enter one additional tilde to act as an escape character for that tilde, and a second additional tilde to denote an access path (for example, if the access path is ~COM1, enter ~~~COM1).

## Examples

```
OPCclient1.'4:0'. '~Modbus Demo Box'
```

The access path is Modbus Demo Box and the OPC item ID is 4:0.

```
OPCclient1.'4:0'
```

The access path is Null and the OPC item ID is 4:0.



**Note** You cannot browse access paths for an item. You must enter access paths manually.

# NIDAQDevice

---



**Note** This section is included for compatibility with previous versions of Lookout. National Instruments recommends that you use OPC Client to connect to NI-DAQ OPC.

Lookout uses the NIDAQDevice object class to communicate with National Instruments data acquisition devices, including data acquisition devices connected in parallel mode to SCXI hardware. Refer to the NISCXI object class for more information concerning configurations using SCXI hardware connected in multiplexed mode.

To use this object, you should have NI-DAQ 5.0 or better software installed. While the NIDAQDevice object works with some earlier versions of NI-DAQ software, it does not perform well with these earlier versions, and has not been extensively tested.

Consult your NI-DAQ hardware and software manuals for information on installing and configuring National Instruments data acquisition software and hardware.

When you create an NIDAQDevice object for the first time, or when you launch Lookout and run an application using the NIDAQDevice object, Lookout automatically loads the NI-DAQ software. This can take a few moments, during which the screen is frozen. Once the NI-DAQ software has loaded, Lookout returns to its former speed.



**Note** This object class is available on 32-bit versions of Lookout 3.7 and later. It is not backward compatible with earlier versions of Lookout, and does not run on the 16-bit version of Lookout.

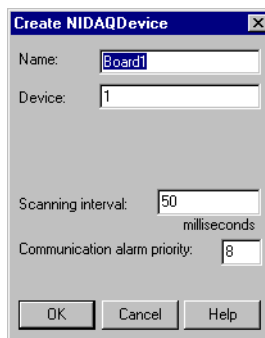

**Figure 3-24.** NIDAQ Device Configuration Parameters Dialog Box

**Device** is the NI-DAQ device number. The DAQ configuration utility (WDAQConf.exe) assigns this number to an installed device. Valid device numbers range is from 1 to 16.

**Scanning interval** is the time period between analog and digital input polls. The valid range is 20 msec to 1 day (expressed in msec). You should also keep in mind that some National Instruments DAQ cards need time to stabilize, and so that a scanning rate that is faster than the stabilization rate of the card returns suspect values.

**Communication alarm priority** determines the priority level of the alarms generated by the NIDAQDevice object.

## NIDAQDevice Data Members

**Table 3-53.** NIDAQDevice Data Members

Data Member	Type	Read	Write	Description
AI0, AI63	numeric	yes	no	Analog input channel in volts.
AO0, AO63	numeric	no	yes	Analog output channel in volts.
CommFail	logical	yes	no	Object-generated signal that is on if, for whatever reason, Lookout cannot communicate with or control the device without error.
DI0, DI31	logical	yes	no	Digital input line.

**Table 3-53.** NIDAQDevice Data Members (Continued)

Data Member	Type	Read	Write	Description
DO0, DO31	logical	no	yes	Digital output line.
Update	logical	yes	no	Object-generated signal that pulses low each time the object polls the device.

## NIDAQ.INI

You may configure individual channel attributes by editing the `NIDAQ.INI` file in your Lookout directory.

To specify a channel, use the following format: `[DEV1.AI5]`

This specifies analog input channel 5 on device number 1.

**UPPERLIMIT** specifies the upper input limit in volts (for example, `UPPERLIMIT=2.5`). Usually used in conjunction with **LOWERLIMIT**.

**LOWERLIMIT** specifies the lower input limit in volts (for example, `LOWERLIMIT=-3.7`). Usually used in conjunction with **UPPERLIMIT**.

**INPUTMODE** specifies the analog input connection mode to use for this channel. Valid choices are 1 for differential, 2 for referenced single-ended, and 3 for non-referenced single-ended.

## NIDAQDevice Error Messages

### Error loading NI-DAQ driver

Lookout was not able to communicate to the NI-DAQ driver. Be sure that NI-DAQ has been installed properly, and the NI-DAQ Configuration Utility has been used to configure the your hardware devices.

**NIDAQ: Analog Input: Invalid Data Member(s)**

**NIDAQ: Analog Output: Invalid Data Member(s)**

**NIDAQ: Digital Input: Invalid Data Member(s)**

**NIDAQ: Digital Output: Invalid Data Member(s)**

At least one channels you have specified is not valid for your current hardware configuration. Be sure your hardware is configured properly using the NI-DAQ Configuration Utility.

**NIDAQ: Error code: NNNNN**

**NIDAQ: Analog Input: Error code: NNNNN**

**NIDAQ: Analog Output: Error code: NNNNN**

**NIDAQ: Digital Input: Error code: NNNNN**

**NIDAQ: Digital Output: Error code: NNNNN**

NI-DAQ has detected an error condition. Please refer to your *NI-DAQ Function Reference Manual* to determine the meaning of the error code.

**Table 3-54.** National Instruments Data Acquisition Devices Supported by Lookout

Device	AI	AO	DIO
AT-AO-6	—	yes	yes
AT-AO-10	—	yes	yes
AT-MIO-16E-1	yes	yes	yes
AT-MIO-16E-2	yes	yes	yes
AT-MIO-16E-3	yes	yes	yes
AT-MIO-16DE-10	yes	yes	yes
AT-MIO-16XE-50	yes	yes	yes
AT-MIO-16X	yes	yes	yes
AT-MIO-16F-5	yes	yes	yes
AT-MIO-64E-3	yes	yes	yes
CS-2017	CJC	—	—
DAQCard-1200	yes	yes	yes
DAQCard-700	yes	—	yes
DAQCard-5XX	yes	—	yes
DAQPad-MIO-16XE-50	yes	yes	yes
DAQPad-1200	yes	yes	yes
Lab-PC+	yes	yes	yes
PC-LP-16	yes	—	yes
SC-2070	CJC	—	—
SCB-68	CJC	—	—
SCB-100	CJC	—	—

# NISCXI

---



**Note** This section is included for compatibility with previous versions of Lookout. National Instruments recommends that you use OPC Client to connect to NI-DAQ OPC.

Lookout uses the NISCXI object class to communicate with National Instruments data acquisition devices connected in multiplex mode to SCXI hardware. Refer to the NIDAQDevice object class for more information concerning parallel SCXI configurations, and data acquisition configurations without SCXI.

To use this object, you should have NI-DAQ 5.0 or better software installed. While the NIDAQDevice object works with some earlier versions of NI-DAQ software, it does not perform well with these earlier versions, and has not been extensively tested.

Consult your NI-DAQ and NI-SCXI hardware, and NI-DAQ software manuals for information on installing and configuring National Instruments data acquisition software and hardware.

When you create an NISCXI object for the first time, or when you launch Lookout and run an application using the NISCXI object, Lookout automatically loads the NI-DAQ software. This can take a few moments, during which the screen is frozen. Once the NI-DAQ software has loaded, Lookout returns to its former speed.



**Note** This object class is available on 32-bit versions of Lookout 3.7 and later. It is not backward compatible with earlier versions of Lookout, and does not run on the 16-bit version of Lookout.

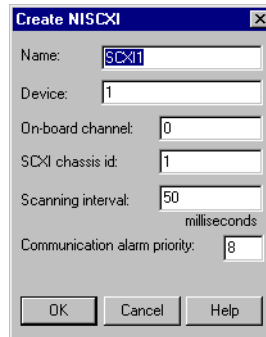

**Figure 3-25.** NISCXI Definition Parameters Dialog Box

**Device** is the NI-DAQ device number of the controlling device. The DAQ configuration utility (`WDAQConf.exe`) assigns this number to an installed device. Valid device numbers range is from 1 to 16.

**On-board channel** specifies the analog input channel of the controlling device used to address this SCXI chassis. When only one chassis is being controlled by the controlling board, this value should be 0. When this chassis in a multi-chassis configuration, this value should reflect the order of this chassis. For instance, the first chassis should be 0, the next chassis should be 1, and so on. Valid range is 0 to 7. If there are no analog input channels in this chassis, use the value 0.

**SCXI chassis id** is the chassis Id number assigned to this chassis by the DAQ configuration utility.

**Scanning interval** is the time period between analog and digital input polls. Valid range is 20 msec to 1 day (expressed in msec).

**Communication alarm priority** determines the priority level of the alarms generated by the NISCXI object.



## NISCXI Data Members

**Table 3-55.** NISCXI Device Data Members

Data Member	Type	Read	Write	Description
CommFail	logical	yes	no	Object-generated signal that is on if, for whatever reason, Lookout cannot communicate with or control the device without error.
MD1.AI0–MD12.AI63	numeric	yes	no	Analog input channel in volts.
MD1.AO0–MD12.AO63	numeric	no	yes	Analog output channel in volts.
MD1.cjtemp– MD12.cjtemp	numeric	yes	no	Built-in cold-junction sensor on analog input terminal blocks.
MD1.DI0–MD12.DI31	logical	yes	no	Digital input line.
MD1.DO0–MD12.DO31	logical	no	yes	Digital output line.
MD1.Etc0–MD12Etc31	numeric	yes	no	Analog input channel with built-in polynomial conversion for an E type thermocouple.
MD1.Jtc0 – MD12Jtc31	numeric	yes	no	Analog input channel with built-in polynomial conversion for a J type thermocouple.
MD1.Ktc0 – MD12Ktc31	numeric	yes	no	Analog input channel with built-in polynomial conversion for a K type thermocouple.
MD1.Rtc0 – MD12Rtc31	numeric	yes	no	Analog input channel with built-in polynomial conversion for an R type thermocouple.
MD1.Stc0 – MD12Stc31	numeric	yes	no	Analog input channel with built-in polynomial conversion for an S type thermocouple.
MD1.Ttc0 – MD12Ttc31	numeric	yes	no	Analog input channel with built-in polynomial conversion for a T type thermocouple.
Update	logical	yes	no	Object-generated signal that pulses low each time the object polls the device.

## Configuring NIDAQ.INI for NISCXI

You may configure individual channel attributes by editing the `NIDAQ.INI` file in your Lookout directory.

### Channel Attributes

To specify a channel, use the following format: `[DEV3.SC1.MD2.AI5]`

This specifies analog input channel 5 on module 2 of SCXI chassis 1 controlled by device 3.

**UPPERLIMIT** specifies the upper input limit in volts (for example, `UPPERLIMIT=2.5`). Usually used in conjunction with **LOWERLIMIT**.

**LOWERLIMIT** specifies the lower input limit in volts (for example, `LOWERLIMIT=-3.7`). Usually used in conjunction with **UPPERLIMIT**.

### Cold-Junction Sensor Attributes

To specify a cold-junction sensor, use the following format:

`[DEV3.SC1.MD2.CJC]`

This specifies the cold-junction sensor on module 2 of SCXI chassis 1 controlled by device 3.

**SENSORTYPE** specifies the type of temperature sensor on the terminal block. Valid choices are `IC` and `THERMISTOR`. Check your SCXI terminal block documentation to determine the correct sensor type.

**RESAMPLE** specifies the number of minutes between resampling the cold-junction sensor. Valid range is 1 to 10080, and 0. Use 0 to only check the cold-junction sensor once at the start, and do not resample the sensor later.

## NISCXI Error Messages

### Error loading NI-DAQ driver

Lookout was not able to communicate to the NI-DAQ driver. Be sure that NI-DAQ has been installed properly, and that you used the NI-DAQ Configuration Utility to configure the your hardware devices.

**NIDAQ: Analog Input: Invalid Data Member(s)**

**NIDAQ: Analog Output: Invalid Data Member(s)**

**NIDAQ: Digital Input: Invalid Data Member(s)****NIDAQ: Digital Output: Invalid Data Member(s)**

At least one channels you have specified is not valid for your current hardware configuration. Be sure your hardware is configured properly using the NI-DAQ Configuration Utility.

**NIDAQ: Error code: NNNNN****NIDAQ: Analog Input: Error code: NNNNN****NIDAQ: Analog Output: Error code: NNNNN****NIDAQ: Digital Input: Error code: NNNNN****NIDAQ: Digital Output: Error code: NNNNN**

NI-DAQ has detected an error condition. Please refer to your *NI-DAQ Function Reference Manual* to determine the meaning of the error code.

**SCXI Devices**

You can use the following National Instruments data acquisition devices with Lookout.

Device	AI	AO	DIO
SCXI-1000	—	—	—
SCXI-1001	—	—	—
SCXI-1100	yes	—	—
SCXI-1102	yes	—	—
SCXI-1120	yes	—	—
SCXI-1121	yes	—	—
SCXI-1124	—	yes	—
SCXI-1160	—	—	yes
SCXI-1161	—	—	yes
SCXI-1162	—	—	yes
SCXI-1163	—	—	yes
SCXI-1163R	—	—	yes
SCXI-1200	yes	yes	yes
SCXI-1300	CJC	—	—

<b>Device</b>	<b>AI</b>	<b>AO</b>	<b>DIO</b>
SCXI-1303	CJC	—	—
SCXI-1320	CJC	—	—
SCXI-1328	CJC	—	—
SCXI-2000	yes	yes	yes
SCXI-2400	yes	yes	yes

# Omron

Omron is a protocol driver class Lookout uses to communicate with Omron devices using the Host Link serial communication protocol.

An Omron object contains a great deal of data. It supports reading and writing of all predefined data points. When you create an Omron object, you have immediate access to all the data members for that object (see *Omron Data Members* list in Table 3-56).

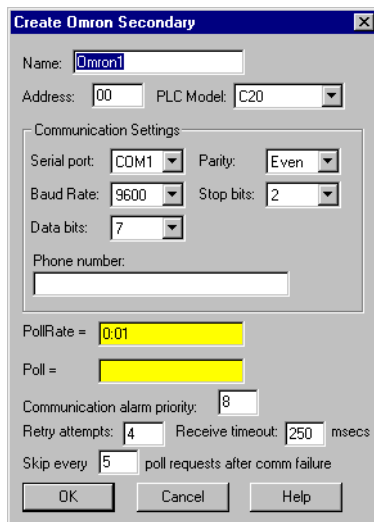

**Figure 3-26.** Omron Definition Parameters Dialog Box

**Serial port** specifies which COM port the object uses for communicating to the external device. This does not specify the communication type. Communication type is determined by the **Options»Serial Ports...** command.

**Data rate** indicates the baud rate that Lookout uses to communicate with the hardware device. This **Data rate** setting should match the selection made on the physical device.

**Data bits** indicates the number of data bits that Lookout uses to communicate with the hardware device. This **Data bits** setting should match the selection made on the physical device.

**Stop bits** indicates the number of stop bits that Lookout uses to communicate with the hardware device. This **Stop bits** setting should match the selection made on the physical device.

**Parity** indicates the parity that Lookout uses to communicate with the hardware device. This **Parity** setting should match the selection made on the physical device.

**Phone number** specifies the number to be dialed if the selected serial port is configured for dial-up. This **Phone number** only applies to the individual protocol object.

**PollRate** is a numeric expression that determines how often to poll the device. The object then polls the device at the specified time interval. Normally, this is a simple time constant such as 0:01 (one second). See *Numeric Data Members* in Chapter 2, *How Lookout Works*, of the *Getting Started with Lookout* manual for more information on entering time constants.

**Poll** is a logical expression. When this expression changes from FALSE to TRUE, Lookout polls the device. You can use a simple expression like the signal from a pushbutton, or a complex algorithm.

**Communication alarm priority** determines the priority level of alarms generated by the Omron object. Such alarms are typically related to communications with the physical device.

**Retry attempts** specifies the consecutive number of times Lookout attempts to establish communications with a device when it is not getting a valid response. After it tries the number of **Retry attempts** specified, the Omron object generates an alarm and releases the communication port back to the communications subsystem. The subsystem then moves on to the next device in the polling queue (if any). See Chapter 3, *Serial Port Communication Service*, in the *Lookout Developer's Manual* for more information.

**Receive timeout** is the time delay Lookout uses in waiting for a response from a device before retrying the request.

The **Skip every...** setting instructs Lookout not to poll a device it has lost communication with on every scheduled poll. Instead, Lookout skips the device in the polling cycle. Once communications have been reestablished, the device is polled on its regular cycle.

## Omron Data Members

As with all Lookout drivers, you can access I/O points and other data through data members. The following is a table of data members currently supported by the Omron object class.

**Table 3-56.** Omron Data Members

Data Member	Type	Read	Write	Description
AR0-AR27	numeric	yes	yes	Auxiliary relay area, read as 16-bit word. (unsigned)
AR0.0-AR27.15	logical	yes	yes	Auxiliary relay area, read as 1-bit discrete.
ARS0-ARS27	numeric	yes	yes	Auxiliary relay area, read as 16-bit word. (signed)
DM0-DM9999	numeric	yes	yes	Data memory area, 16-bit word. (unsigned)
DMBCD0-DMBCD9999	numeric	yes	yes	Data memory area, binary coded decimal.
DMS0-DMS9999	numeric	yes	yes	Data memory area, 16-bit word. (signed)
CommFail	logical	yes	no	Object-generated signal that is on if, for any reason, Lookout cannot communicate with the device(s).
HR0-HR99	numeric	yes	yes	Holding relay area, read as 16-bit word. (unsigned)
HR0.0-HR99.15	logical	yes	yes	Holding relay area, read as 1-bit discrete.
HRS0-HRS99	numeric	yes	yes	Holding relay area, read as 16-bit word. (signal)
IR0-IR511	numeric	yes	yes	I/O area, read as 16-bit word.
IR0.0-IR511.15	logical	yes	yes	I/O area, read as 1-bit discrete.
IRS0-IRS11	numeric	yes	yes	I/O area, reads 16-bit word. (signed)
LR0-LR63	numeric	yes	yes	Link relay area, read as 16-bit word of information. (unsigned)

**Table 3-56.** Omron Data Members (Continued)

Data Member	Type	Read	Write	Description
LR0.0–LR63.15	logical	yes	yes	Link relay area, read as 1-bit discrete.
LRS0–LRS63	numeric	yes	yes	Link relay area, read as 16-bit word. (signed)
TC0–TC999	numeric	yes	no	Timer/Counter, read as 16-bit word.
Update	logical	yes	no	Object-generated signal that pulses low each time it polls the device.



**Note** The Omron requires a special cable configuration in order to work properly. See your Omron hardware documentation for the correct configuration.

## Omron Status Messages

### No response within timeout period

Lookout received no response from a device within the **Receive timeout** period. The Omron object is able to use the COM port, but when it polls the device, it does not respond—as if it is not even there.

### Cannot set PLC to MONITOR mode

The Omron object is trying to set the PLC in MONITOR mode in order to communicate with the PLC correctly, but cannot perform the operation.

### Incorrect address in response

The frame received had an incorrect source address. Check for two or more devices with the same address.

### Incorrect command in response

The frame received had an incorrect command. Check for two or more devices with the same address.

### Incorrect data type in response

The frame received had an incorrect data type marker.

### Incorrect frame check sum (FCS)

The frame received had an incorrect check sum.

### Omron errors reported in the response

These errors are reported by the Omron device, and are in turn reported to you in text form.



## **Omron Models Supported**

C20, C200, C500, C1000, C2000, CQM, CPM1

# OptoHostWords

OptoHostWords is a protocol driver class Lookout uses to communicate with Opto22 controllers using HostWords protocol.

Unlike other Lookout driver objects, OptoHostWords does not give you direct access to the Opto22 I/O. Opto22 I/O is handled through the controller, which you program with the OptoControl software.

You also have access to string and numerical variables of your own definition when working with the Opto22 controller.

You must furnish the Lookout HostWords data members with the variable names you assign when you program the Opto22 controller. The Lookout data members are documented as having a `.name` suffix. When you make connections with the OptoHostWords object, you must use the name from the program running on your Opto22 controller.



**Note** HostWords names are case sensitive.

**Figure 3-27.** OptoHost Definition Parameters Dialog Box: Serial

**Medium** selects whether to use Ethernet or serial communications.

**Serial port** specifies which port the object uses for communication to the PLC.

**Baud Rate** specifies the speed at which the object communicates with the PLC.

**Phone number** specifies the number to be dialed if the serial port setting is configured for dial-up. This number only applies to the individual protocol object.

**PollRate** is a numeric expression that determines how often to poll the device. Normally, this is a simple time constant such as 0:01 (one second). See *Numeric Data Members* in Chapter 2, *How Lookout Works*, of the *Getting Started with Lookout* manual for information on entering time constants.

**Poll** is a logical expression. When this expression changes from FALSE to TRUE, Lookout polls the device. You can use a simple expression like the signal from a pushbutton, or a complex algorithm.

**Communication alarm priority** determines the priority level of object-generated alarms (0 – 10).

**Receive timeout** is the time the object waits for a response from a device before retrying a request.

**Retry attempts** specifies the consecutive number of times Lookout attempts to establish communications with a device if it is not getting a valid response. After it tries the number of **Retry attempts** specified, the object generates an alarm and releases the COM port. See Chapter 3, *Serial Port Communication Service*, in the *Lookout Developer's Manual* for more information.

The **Skip every** setting instructs the object to skip the next specified number of polls to the PLC in the event of a communications failure, before attempting to re-establish communications. Once communications have been re-established, the device is polled on its regular cycle.

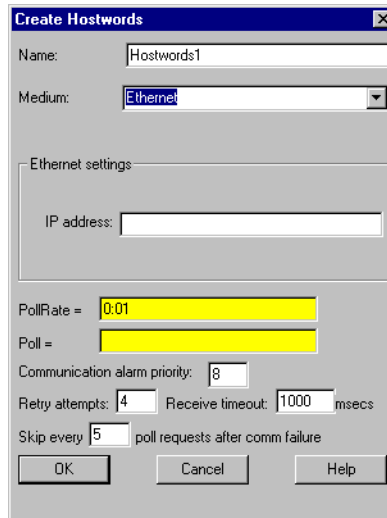

**Figure 3-28.** OptoHostWords Definition Parameters Dialog Box: Ethernet

**IP Address** specifies the IP address of the Opto22 controller.

## Configuring the Hostwords Controller

Any time you download your OptoControl strategy onto the controller, you can choose to send library files along with it. One of these library files, `HOSTWORDS.CTL`, is necessary for the controller to interpret and send HostWords commands.

To make sure you have your system properly configured, use the following steps:

1. Open OptoControl, and bring up the strategy you want to download to the controller.
2. Select the **Controllers** command from the **Configure** menu.
3. Select the controller you are downloading *to* and click on the **Download Options** button.
4. In the **After Run File** section, add a file called `HOSTWORDS .CTL`. This file ships on the OptoControl CD.
5. Click on **OK** to finish in all open dialog boxes.
6. Download to the controller from OptoControl.

## OptoHostWords Data Members

The suffix for the OptoHostWords data members in Table 3-57 is *name*. You provide the name yourself when you program the Opto22 controller with the OptoControl software.

**Table 3-57.** OptoHostWords Data Members

<b>Data Member</b>	<b>Type</b>	<b>Read</b>	<b>Write</b>	<b>Description</b>
<i>APT.name</i>	numeric	yes	yes	Analog point
<i>APTFILTC.name</i>	logical	no	yes	Analog point filter clear
<i>APTFILTW.name</i>	numeric	no	yes	Analog point filter weight
<i>APTMAX.name</i>	numeric	yes	no	Analog point maximum
<i>APTMAXC.name</i>	logical	yes	no	Analog point maximum clear
<i>APTMIN.name</i>	numeric	yes	no	Analog point minimum
<i>APTMINC.name</i>	logical	no	yes	Analog point minimum clear
<i>APTTOT.name</i>	numeric	yes	yes	Read analog point totalizer
<i>APTTOTC.name</i>	logical	no	yes	Analog point totalizer clear
<i>APTTOTR.name</i>	numeric	no	yes	Analog point totalizer rate
<i>Chart.name</i>	logical	no	yes	Opto22 flowchart. This data member runs an Opto22 flowchart you previously created.
CommFail	logical	yes	no	Object-generated signal that is ON if the object cannot communicate with the PLC.
Date	text	yes	no	date read from controller
DateSynch	logical	no	yes	When TRUE, Lookout writes current date from system clock to controller
<i>DPT.name</i>	logical	yes	yes	Digital point
<i>DPTCNT.name</i>	numeric	yes	yes	Digital point counter
<i>DPTCNTC.name</i>	logical	no	yes	Digital point counter clear
<i>DPTCNTEN.name</i>	logical	no	yes	Digital point counter enable

**Table 3-57.** OptoHostWords Data Members (Continued)

<b>Data Member</b>	<b>Type</b>	<b>Read</b>	<b>Write</b>	<b>Description</b>
<i>DTPOFFLAT.name</i>	logical	yes	no	Digital point latch off
<i>DTPOFFLATC.name</i>	logical	no	yes	Digital point clear latch off
<i>DTPONLAT.name</i>	logical	yes	no	Digital point latch on
<i>DTPONLATC.name</i>	logical	no	yes	Digital point clear latch on
<i>PIDACTIVE.name</i>	logical	no	yes	Proportional/ Differential/Integral control active and performing calculations
<i>PIDAUTO.name</i>	logical	no	yes	Output is affected by the Proportional/ Differential/Integral control calculations
<i>PIDD.name</i>	numeric	yes	yes	Proportional/ Differential/Integral control differential term
<i>PIDI.name</i>	numeric	yes	yes	Proportional/ Differential/Integral control integral term
<i>PIDINPUT.name</i>	numeric	yes	no	Proportional/ Differential/Integral control input
<i>PIDOUTPUT.name</i>	numeric	yes	no	Proportional/ Differential/Integral control output
<i>PIDP.name</i>	numeric	yes	yes	Proportional/ Differential/Integral control proportional
<i>PIDSET.name</i>	numeric	yes	yes	Proportional/ Differential/Integral control setpoint
Poll	logical	no	yes	When this expression transitions from FALSE to TRUE, Lookout polls the device.

**Table 3-57.** OptoHostWords Data Members (Continued)

<b>Data Member</b>	<b>Type</b>	<b>Read</b>	<b>Write</b>	<b>Description</b>
PollRate	numeric	no	yes	Lookout expression that determines the device polling frequency.
STR.name	text	yes	yes	String
STRT.name.0	text	yes	yes	String table
Time	text	yes	no	Time read from the device
TimeSynch	logical	no	yes	When TRUE, Lookout writes current time from system clock to controller
Update	logical	yes	no	Object-generated signal that pulses low each time it polls the device
VARF.name	numeric	yes	yes	Variable floating point
VARFT.name.0	numeric	yes	yes	Variable floating point table
VARI.name	numeric	yes	yes	Variable integer
VARIT.name.0	numeric	yes	yes	Variable integer table

## OptoHostWords Status Messages

There are three categories of error messages you may receive when using OptoHostWords

- Windows TCP/IP Errors
- Lookout Driver Errors
- HostWords Error Codes

One of the most common errors is the Host port device error:

### **Controller received an undefined command: *name***

This error informs you that the name listed is incorrect. To fix this error, make sure the name you attempted to use matches the name you used in your OptoControl program.

## OptoHostwords TCP/IP Errors

### **Socket Communications error**

This error message returns one of the standard Windows socket errors:

### **Socket timed out while attempting to connect**

### **No Response from socket**

### **Unknown socket error**

### **Cannot resolve IP address**

### **Cannot resolve port**

## Lookout Driver Errors with OptoHostWords

### **Garbled or unexpected response**

This error can happen in Ethernet or serial communications. This error means the driver received a message it could not make sense of.

### **No response**

This error means that a serial device has not responded at all.

## HostWords Errors

The following General, Host Port Device, Ethernet, and HostWords errors are the most common error codes encountered when using the Lookout OptoHostWords driver. For a complete list of HostWords errors, or more detailed explanations, consult your HostWords documentation.

One of the most common errors is the Host port device error:

### **Controller received an undefined command: *name***

This error informs you that the name listed is incorrect. To fix this error, make sure the name you attempted to use matches the name you configured under HostWords

### **Invalid port number**

This indicates your have sent a peer message to the same controller, or have encountered a firmware error.

### **Send timeout**

You may have to increase your port timeout delay. This error can also result from lending long strings to a serial port, CTS low on a host port, or a firmware error.



**Bad table index**

You may have a negative table index value, or an index value greater than the table length.

**Numeric overflow**

The result of the calculation is larger than the numeric type used.

**Not a number**

A math operation has resulted in a complex or imaginary number.

**Divide by zero**

A math operation has tried to divide by zero.

**Bus fault**

This indicates either a failure in the controller hardware, or an attempt to access invalid memory area.

**Port already in use**

This indicates an attempt to have more than one port open in a chart.

**Invalid event/reaction hold buffer**

This indicates an attempt to read an event/reaction data hold buffer for an event/reaction that was not configured with a read and hold reaction.

**Host port relock**

An error occurring after an unlock command.

**String too short to hold data**

You may have had a string variable too short for the data specified, or attempted to put the date or time in a string with a length of less than eight.

**Wrong object type**

You may have passed the wrong data type to the ENABLE and DISABLE commands.

**Controller received an undefined command**

Check your use of the name returned by the error message. Names must match those you configured in your OptoControl configuration.

**Controller received a message with a bad CRC**

This indicates a problem in communication between your PC and the controller. See the HostWords documentation for a more detailed explanation.

**Controller power up clear**

Controller has lost power since the last communication. See the HostWords documentation for a more detailed explanation.

**Controller received insufficient data**

There may be a error in your command syntax.

**I/O unit not configured**

See the HostWords documentation for a more detailed explanation.

**Controller host port is busy**

The command that returned this message is not executed. See the HostWords documentation for a more detailed explanation.

**Controller stack is empty**

See the HostWords documentation for a more detailed explanation.

**Controller Stack is full**

See the HostWords documentation for a more detailed explanation.

**Unknown response**

An Ethernet communication may have been stopped by a bus error, or there may have been a firmware error.

**Invalid Port**

You have attempted to acquire a port that does not exist. See the HostWords documentation for a more detailed explanation.

**No more sessions**

An attempt has been made to open too many Ethernet sessions. See the HostWords documentation for a more detailed explanation.

**Open session timeout**

An attempt to open a session exceeded the timeout interval. See the HostWords documentation for a more detailed explanation.

**Close session timeout**

An attempt to close a session exceeded the timeout interval. See the HostWords documentation for a more detailed explanation.

**Session not open**

See the HostWords documentation for a more detailed explanation.

**Invalid Session number**

See the HostWords documentation for a more detailed explanation.

**No session selected**

There is no active session for the specified port.

**Wrong LC type**

A command has been used that is the wrong type for the current controller.

**Bad Address**

See the HostWords documentation for a more detailed explanation.

**Operation failed**

Could not gain access to the PC bus. See the HostWords documentation for a more detailed explanation.

**Character not found**

The **Find Character in String** command could not find the specified character.

**Substring not found**

The **Find Substring in String** command could not find the specified substring.

# OptoMistic

Lookout uses the OptoMistic driver to communicate directly with Opto Model 200 I/O modules.

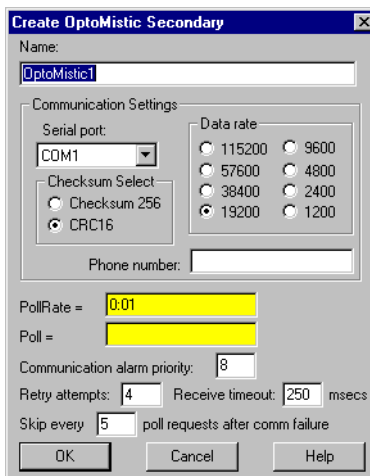

Figure 3-29. OptoMistic Parameter Definition Dialog Box.

**Serial port** specifies which port the object uses for communication to the external device. This does not specify the communication type. Communication type is determined by the **Options»Serial Ports...** command.

**Checksum Select** chooses which checksum method to use.

**PollRate** is a numeric expression that determines how often to poll the device. The object then polls the device at the specified time interval. Normally, this is a simple time constant such as 0:01 (one second). See *Numeric Data Members* in Chapter 2, *How Lookout Works*, of the *Getting Started with Lookout* manual for information on entering time constants.

**Poll** is a logical expression. When this expression changes from FALSE to TRUE, Lookout polls the device. You can use a simple expression like the signal from a pushbutton, or a complex algorithm.

**Communication alarm priority** determines the priority level of alarms generated by the object. Such alarms are typically related to communications with the physical device.

**Retry attempts** specifies the consecutive number of times Lookout attempts to establish communications with a device if it is not getting a valid response. After it tries the number of **Retry attempts** specified, the object generates an alarm and releases the communication port back to the communications service which then moves on to the next device in the polling queue (if any). Refer to Chapter 3, *Serial Port Communication Service*, in the *Lookout Developer's Manual* for more information.

**Receive timeout** is the time delay Lookout uses in waiting for a response from a device before retrying the request.

The **Skip every...** setting instructs Lookout to not poll a device it has lost communication with on every scheduled poll. Instead, Lookout skips the device in the polling cycle accordingly. Once communications have been reestablished, the device is polled on its regular cycle.

## OptoMistic Data Members

**Table 3-58.** OptoMistic Data Members

Data Member	Type	Read	Write	Description
AI0.09—AI255.15	numeric	yes	no	Analog input
AO0.0—AO255.15	numeric	yes	yes	Analog output
CommFail	logical	yes	no	Object-generated signal that is on if, for whatever reason, Lookout cannot communicate with the ROC
DI0.0—DI255.15	logical	yes	no	Digital input
DICNT0.0—DICNT255.15	numeric	yes	no	Digital input counter
DICNTC0.0—DICNTC255.15	logical	no	yes	Digital input counter clear
DICNTE0.0—DICNTE255.15	logical	no	yes	Digital input counter enable
DIFRQ0.0—DIFRQ255.15	numeric	yes	no	Digital input frequency
DILN0.0—DILN255.15	logical	yes	no	Digital input latch negative (read only)
DILNC0.0—DILNC255.15	logical	no	yes	Digital input latch negative (write only)

**Table 3-58.** OptoMistic Data Members (Continued)

<b>Data Member</b>	<b>Type</b>	<b>Read</b>	<b>Write</b>	<b>Description</b>
DILP0.0—DILP255.15	logical	yes	no	Digital input latch positive (read only)
DILPC0.0—DILPC255.15	logical	no	yes	Digital input latch positive (write only)
DIOFFP0.0—DIOFFP255.15	numeric	yes	no	Digital input OFF pulse totalizer
DIOFFPC0.0—DIOFFPC255.15	logical	no	yes	Digital input OFF pulse totalizer clear
DIONP0.0—DIONP255.15	numeric	yes	no	Digital input ON pulse totalizer
DIONPC0.0—DIONPC255.15	logical	no	yes	Digital input ON pulse totalizer clear
DIPRD0.0—DIPRD255.15	numeric	yes	no	Digital input period
DIPRDC0.0—DIPRDC255.15	logical	no	yes	Digital Input period clear
DO0.0—DO255.15	logical	yes	yes	Digital Output
Offhook	logical	no	yes	When TRUE, this flag instructs the object to retain exclusive use of its assigned communication port.
Poll	logical	no	yes	When this value transitions from FALSE to TRUE, Lookout polls the device.
PollRate	numeric	no	yes	Lookout expression that determines the device polling frequency
Update	logical	yes	no	Object-generated signal that pulses low each time it polls the device

## OptoMistic Error Messages

**No Response within timeout period**

**Message Garbled**

**Unexpected data response length**

**Response too short**

**No response (configuring)**

Each of these messages indicates a communications error. See your OptoMistic documentation for more detailed information.

**Mistic Error: Undefined command**

Recheck your OptoMistic address. See your OptoMistic documentation for more detailed information.

**Mistic Error: Checksum or CRC error**

This message indicates a general COM error. See your OptoMistic documentation for more detailed information.

**Mistic Error: Power-up clear error**

This error message may include a code detailing more specific information. See your OptoMistic documentation for more detailed information.

**Mistic Error: Communications link watchdog timeout error**

This message may indicate an address problem. See your OptoMistic documentation for more detailed information.

**Mistic Error: Busy error**

The system was busy and did not return data.

**Mistic Error: Invalid module type error**

The driver has attempted to read a module of a type different than the module located at the address.

# Optomux

Optomux is a protocol driver class Lookout uses to communicate with Opto 22 I/O devices and other equipment using the Optomux communication protocol.

This protocol driver uses Optomux 2-pass protocol with no parity, eight data bits, and one stop bit. You can choose between CRC16 and BCC error correction modes, and select a data rate.

Several physical Optomux devices can be daisy-chained or multidropped on one ASCII network. In Lookout, you create a single Optomux object to represent all devices connected to the same COM port.

An Optomux object contains a great deal of data. It represents all devices and their associated channels. It supports reading and writing of all predefined data point types including analog input, discrete input, analog output, discrete output, counter, latch, latch clear, and temperature. When you create an Optomux object, you have immediate access to all the object data members (see data member list in Table 3-59).

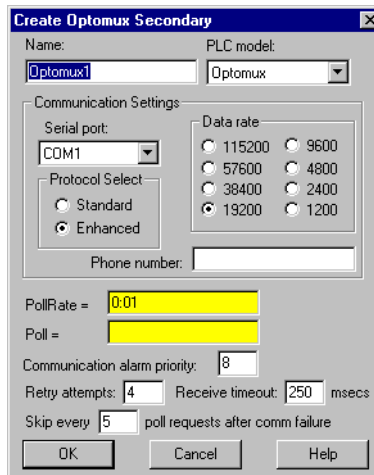

**Figure 3-30.** Optomux Definition Parameters Dialog Box

**Serial port** specifies which COM port the object uses for communicating to the external device. This does not specify the communication type. Communication type is determined by the **Options»Serial Ports...** command.



**Protocol Select** specifies the type of error correction mode used by the RTU. **Enhanced** mode uses CRC16 error checking. **Standard** mode uses BCC (horizontal parity). **Enhanced** mode is the default and is recommended.

**Data rate** indicates the baud rate that Lookout uses to communicate with the hardware device. This setting should match the selection made on the physical device.

**Phone number** specifies the number to be dialed if the selected serial port is configured for dial-up. This number only applies to the individual protocol object.

**PollRate** is a numeric expression that determines how often to poll the device. The object then polls the device at the specified time interval. Normally, this is a simple time constant such as 0:01 (one second). See *Numeric Data Members* in Chapter 2, *How Lookout Works*, of the *Getting Started with Lookout* manual for information on entering time constants.

**Poll** is a logical expression. When this expression changes from FALSE to TRUE, Lookout polls the device. You can use a simple expression like the signal from a pushbutton, or a complex algorithm.

**Communication alarm priority** determines the priority level of alarms generated by the Optomux object. Such alarms are typically related to communications with the physical device.

**Retry attempts** specifies the consecutive number of times Lookout attempts to establish communications with a device if it is not getting a valid response. After it tries the number of **Retry attempts** specified, the Optomux object generates an alarm and releases the communication port back to the communications subsystem, which then moves on to the next device in the polling queue (if any). Refer to Chapter 3, *Serial Port Communication Service*, in the *Lookout Developer's Manual* for more information.

**Receive timeout** is the time delay Lookout uses in waiting for a response from a device before retrying the request.

The **Skip every...** setting instructs Lookout to not poll a device it has lost communication with on every scheduled poll. Instead, Lookout skips the device in the polling cycle accordingly. Once communications have been reestablished, the device is polled on its regular cycle.

## Optomux Watchdog Capability

The Optomux protocol has a built in watchdog capability. The device monitors communications at all times. If the device receives no communications within the amount of time specified by `WDTime`, the device goes into *watchdog state*. This state makes sure all your devices are in a fail-safe condition if there is any kind of COM failure.

The DWD and AWD data members write to the device the values that device will use if it enters the watchdog state. They are write only.

Notice that the DWD data members are not logical values, as you might expect them to be. They also do not have channel numbers. This is because you set the watchdog data of an entire discrete module with one command and one value. Because there may be 16 channels possible, the single value sent may be as large as 16-bit.

For example, if you want to set the watchdog data for the discrete output module (DWD) at address 3, perform the following steps:

1. Connect a numeric value, such as 10 seconds, to `WDTime`. There has to be something connected to data member or you cannot set watchdog data. `WDTime` reads the numeric input as milliseconds; to set the watchdog time to 10 seconds, the numeric input must be 10000.
2. If you want Channels 1, 2, and 16 to be ON when the device goes into watchdog state, and all other channels to be OFF, send the hex value `0x8003` to `DWD3`. This expands to 1000 0000 0000 0011 in binary (Optomux arranges channels from left to right in the binary sequence). You can use the **Change»Numeric Format...** option to create a hexadecimal numeric in Lookout.

AWD data members work the same way, except that you have a separate data member for each channel, and you give it a numeric value. To set channel 3 of the analog output module at address 10, you would connect the numeric value to `AWD10.3`.

## Optomux Data Members

As with all Lookout drivers, you can access I/O points and other data through data members. The following is a table of data members currently supported by the Optomux object class.

**Table 3-59.** Optomux Data Members

Data Member	Type	Read	Write	Description
AI0.1 – AI255.16	numeric	yes	no	Analog input. 12 bit word containing an unsigned integer ranging from 0 to 4095
AO0.1 – AO255.16	numeric	yes	yes	Analog output. 12 bit word containing an unsigned integer ranging from 0 to 4095
AWD0.1 – AWD255.16	numeric	no	yes	Analog watchdog data
CNT0.1 – CNT255.16	numeric	yes	no	Counter. Returns accumulated count for specified inputs
CommFail	logical	yes	no	Object-generated signal that is on if, for whatever reason, Lookout cannot communicate with the device(s)
DI0.1 – DI255.16	logical	yes	no	Discrete input
DO0.1 – DO255.16	logical	yes	yes	Discrete output
DWD0 – DWD255	numeric	no	yes	Discrete watchdog data
LAT0.1 – LAT255.16	logical	yes	no	Returns ON status for inputs which are latched
LTC0.1 – LTC255.16	logical	yes	no	Returns ON status for latched input and clears the latch
Update	logical	yes	no	Object-generated signal that pulses low each time it polls the device
WDtime	numeric	no	yes	Watchdog time (in ms)

**Comments** To specify the address of an analog input located on channel 4 of module 3, you would enter AI3.4, where

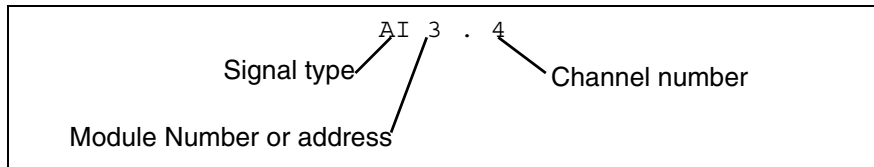

**Note** The Optomux protocol may perform limited value-type verifications depending upon the hardware you use. In other words, trying to read analog input data from a discrete module may be allowed but the data returned may be arbitrary (or zero).

## Optomux Status Messages

### No response within timeout period

Lookout received no response from a device within the **Receive timeout** period. The Optomux object is able to use the COM port, but when it polls the device, it does not respond—as if it is not even there. If you have daisy-chained several devices, you have introduced an inherent delay. You may have to significantly increase **Receive timeout** (and **Poll Rate**) to ensure Lookout is allowing enough time to receive the expected response. This increase has nothing to do with the processing capabilities of Lookout. Rather it is based solely on **Data rate** and the number of devices on the chain. Also, verify your baud rate settings, cable connections, power, configuration settings, COM port settings, and polling addresses.

### Invalid data request from module

Either you tried to read from a module that is missing, or you attempted a data type mismatch. For example, you may have tried to read a discrete value from an analog module. This data type mismatch is seen on a data analyzer as a frame containing question marks. This may be an addressing problem. Verify that the type of I/O at the desired channel matches the signal type of the address identified in the data member you are writing to.

### Message garbled – Bad CRC or BCC

The Optomux object is receiving a poll response from the device(s), but it could not decipher the response. Verify that the error correction scheme you selected in **Protocol Select** is the same as that of all of the physical devices. Also verify that all devices connected to the COM port have unique addresses. It may also be that the last part of the message is getting clipped off before it is completed. Consider increasing the number of **Retry**

**attempts.** You may have to increase the **Receive gap** Serial Port setting to ensure Lookout is receiving the entire message. If your Serial Port is configured for radio this could be caused by an audible squelch tail occurring at the end of a radio transmission. You may need to adjust the **RTS delay off** or the **CTS timeout** settings.

### **Unexpected data response length**

The Optomux object is receiving a poll response from the device(s), but the response is too long. Verify that all devices connected to the COM port have unique addresses. Devices with identical addresses may be trying to respond at the same time.

### **Response too short**

The Optomux object is receiving data that does not meet the minimum frame length requirements. This could happen if you configured a device for 4-pass instead of 2-pass protocol. Lookout uses 2-pass protocol. Verify device protocol settings.

# Philips

Philips is a protocol driver class Lookout uses to communicate with Philips devices using the PPCOMM communication protocol.

A Philips object contains a great deal of data. It supports reading and writing of all predefined data points. When you create a Philips object, you have immediate access to all the object data members (see [Philips Data Members](#) list in this section).

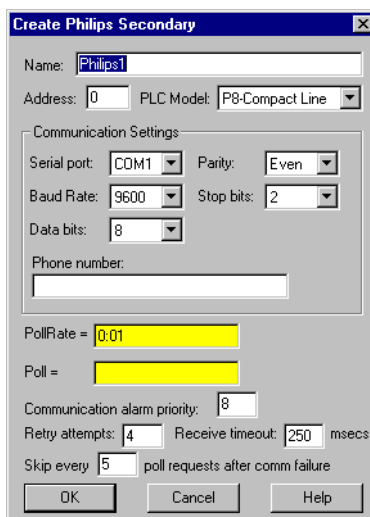

**Figure 3-31.** Philips Configuration Parameters Dialog Box

**Serial port** specifies which communications port the object uses for communicating to the external device. This does not specify the communication type. Communication type is determined by the **Options»Serial Ports...** command.

**Baud rate** indicates the baud rate that Lookout uses to communicate with the hardware device. This setting should match the selection made on the physical device.

**Data bits** indicates the number of data bits that Lookout uses to communicate with the hardware device. This setting should match the selection made on the physical device.

**Stop bits** indicates the number of stop bits that Lookout uses to communicate with the hardware device. This setting should match the selection made on the physical device.

**Parity** indicates the parity that Lookout uses to communicate with the hardware device. This setting should match the selection made on the physical device.

**Phone number** specifies the number to be dialed if the selected serial port is configured for dial-up. This number only applies to the individual protocol object.

**PollRate** is a numeric expression that determines how often to poll the device. The object then polls the device at the specified time interval. Normally, this is a simple time constant such as 0:01 (one second). See *Numeric Data Members* in Chapter 2, *How Lookout Works*, of the *Getting Started with Lookout* manual for information on entering time constants.

**Poll** is a logical expression. When this expression changes from FALSE to TRUE, Lookout polls the device. You can use a simple expression like the signal from a pushbutton, or a complex algorithm.

**Communication alarm priority** determines the priority level of alarms generated by the Philips object. Such alarms are typically related to communications with the physical device.

**Retry attempts** specifies the consecutive number of times Lookout attempts to establish communications with a device if it is not getting a valid response. After it tries the number of **Retry attempts** specified, the Philips object generates an alarm and releases the communication port back to the communications service which then moves on to the next device in the polling queue (if any). Refer to Chapter 3, *Serial Port Communication Service*, in the *Lookout Developer's Manual* for more information.

**Receive timeout** is the time delay Lookout uses in waiting for a response from a device before retrying the request.

The **Skip every...** setting instructs Lookout not to poll a device it has lost communication with on every scheduled poll. Instead, Lookout skips the device in the polling cycle accordingly. Once communications have been reestablished, the device is polled on its regular cycle.

## Philips Data Members

As with all Lookout drivers, you can access I/O points and other data through data members. The following is a table of data members currently supported by the Philips object class.

**Table 3-60.** Philips Data Members

Data Member	Type	Read	Write	Description
CommFail	logical	yes	no	Object-generated signal that is on if Lookout cannot communicate with the device(s)
IB0.0 – IB1023.1	numeric	yes	yes	Discrete inputs, 8 bits
ID0 – ID1023	numeric	yes	yes	Discrete inputs, 32 bits
IW0 – IW1023	numeric	yes	yes	Discrete inputs, 16 bits
IX0.0 – IX123.15	logical	yes	no	Discrete input, 1 bit
MB0.0 – M14335.1	numeric	yes	yes	Data register, 8 bits
MD0 – MD14335	numeric	yes	yes	Data register, 32 bits
MW0 – MW14335	numeric	yes	yes	Data register, 16 bits
MX0.0 – MX14335.15	logical	yes	no	Data register, 1 bit
Poll	logical	no	yes	When this value transitions from FALSE to TRUE, Lookout polls the device.
PollRate	numeric	no	yes	Lookout expression that determines the device polling frequency.
QB0.0 – QB1023.1	numeric	yes	yes	Discrete outputs, 8 bits
QD0 – QD1023	numeric	yes	yes	Discrete outputs, 32 bits
QW0 – QW1023	numeric	yes	yes	Discrete outputs, 16 bits
QX0.0 – QX1023.15	logical	yes	no	Discrete output, 1 bit
Update	logical	yes	no	Object-generated signal that pulses low each time it polls the device.



## Philips Status Messages

**Invalid frame format**

**Bad Checksum**

**Invalid frame length**

These messages indicate garbled communications. Check cabling for signal noise or multiple devices with the same address.

## Philips Alarms

These are messages returned to Lookout in a response frame. See your Philips documentation for meanings and solutions.

# Phoneducer

Use the Phoneducer object to communicate with an Elwood Phoneducer. Lookout uses this object to dial up the Phoneducer from a modem connected to your computer, then holds the connection open to receive a value at varying intervals.

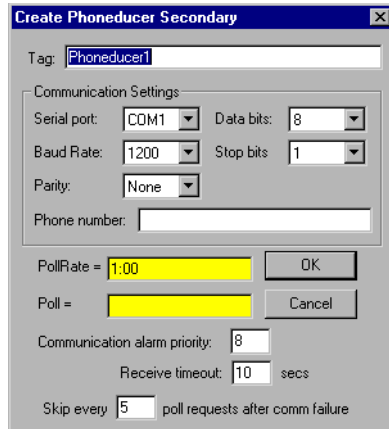

**Serial port** specifies which COM port on the host computer that Lookout object uses for connecting to the modem used to dial up the Phoneducer. See Chapter 3, *Serial Port Communication Service*, of the *Lookout Developer's Manual* for more information on configuring serial ports for use with Lookout.

**Data rate, Parity, Data bits, and Stop bits** reference the settings on the Phoneducer device.

**Phone** specifies the telephone number to be dialed. This number only applies to the individual Phoneducer object.

**PollRate** is a numeric expression that works differently for the Phoneducer object than for other Lookout objects. The PollRate specifies how often Lookout will dial out to the Phoneducer. Normally, this is a simple time constant such as 0:05 (five seconds). See *Numeric Data Members* in Chapter 2, *How Lookout Works*, of the *Getting Started with Lookout* manual for information on entering time constants.

If you set the `OffHook` data member to `TRUE`, Lookout does not hang up after the Phoneducer returns a value, but keeps the modem connection open to receive new data. If you set the `OffHook` data member to `FALSE`

(default), Lookout breaks the modem connection with the Phoneducer and dials again later according to the **PollRate** setting.

**Poll** is a logical expression. When this expression changes from FALSE to TRUE, Lookout dials the Phoneducer. Use a simple expression like the signal from a pushbutton, or a complex algorithm to trigger this event.

**Communication alarm priority** determines the priority level of the alarms generated by the Phoneducer object.

The Phoneducer object does not retry when it does not receive an answer. Set the **Skip every *n* poll requests after comm failure** to determine how many polls Lookout will skip before attempting to redial.

In the Phoneducer object, **Receive timeout** is the time delay that Lookout waits for a response from a device before generating an alarm. Ten seconds is a typical timeout setting for the Phoneducer object configured to generate a data value every 5 seconds.

## Phoneducer Data Members

**Table 3-61.** Phoneducer Data Members

Data Member	Type	Read	Write	Description
CommFail	logical	yes	no	Object-generated signal that is on if Lookout cannot communicate with the device.
OffHook	logical	no	yes	When TRUE, this flag instructs the Phoneducer object to retain exclusive use of its assigned communication port.
Poll	logical	no	yes	When this value transitions from FALSE to TRUE, Lookout polls the device.
PollRate	numeric	no	yes	Lookout expression that determines the device polling frequency.
Update	logical	yes	no	Object-generated signal that pulses low each time it polls the device.
Value	Numeric	yes	no	The value most recently acquired by the Phoneducer.

## Phoneducer Status Messages

Lookout displays the following status messages with the Phoneducer driver object.

### **No response within timeout period**

Lookout did not receive a response from the device within the **Receive timeout** period. Significantly increase **Receive timeout** and **Poll Rate** to ensure that Lookout allows enough time to receive the expected response. Also, verify the connection to the modem dialing the Phoneducer.

### **Garbled response**

A response was received from the Phoneducer, but the value was invalid or corrupted.

# Profibus DP

---

Profibus DP is a protocol driver class for communicating with PLCs and remote I/O units using the Decentralized Periphery protocol in the Profibus standard. The Lookout driver currently supports the S-S Technologies card 5136-PFB PC card only.

## Configuring the Profibus DP Network

In order to use the Lookout Profibus DP driver for the S-S card, you must first configure your DP network using the Siemens COM ET-200 software. This software is not included in the Lookout release and must be purchased separately. The S-S card is the master device on the Profibus network. Because the COM ET-200 software does not know about this device, you must select some other device as the master. You may leave all of its parameters as the defaults because the S-S card ignores the parameters of this master system.

You must, however, enter a master station number and configure the bus parameters. These parameters are used by the SS card to configure the DP network.

Next, you must configure the parameters for each of the slave devices. Refer to the online documentation for the COM ET200 software for instructions on how to do this. Once all the slave devices are configured, save the file to an `.et2` format and export the file to a binary file `.2bf` format. This last step is done using the Export selection in the File menu. Place the binary file in a location accessible to Lookout.

## Profibus DP Requirements

To run the 32-bit version of this object, you must be running Windows NT 3.51 or greater or Windows 95, with an S-S Technologies 5136-PFB card installed in the computer. Lookout automatically loads the firmware module when an object is created.

You must place the configuration file in COM ET 200 binary format in a directory accessible to Lookout.

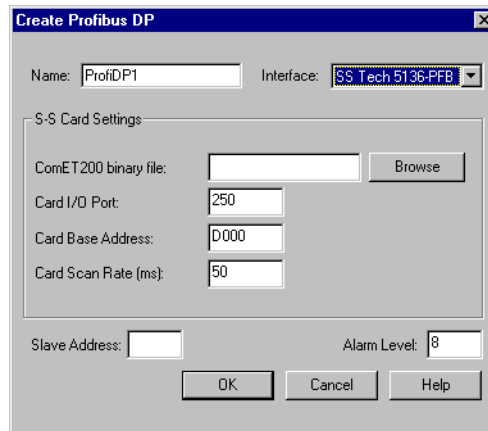

**Figure 3-32.** Profibus DP Configuration Parameters Dialog Box

**Interface** is the type of card to be used to communicate with the DP network. At present, this driver only supports the S-S card interface.

**Slave Address** is the Profibus address for the particular slave device that this object is to communicate with.

**Alarm Level** determines the priority level of object-generated alarms (0 – 10).

## PFB Card Settings

**COM ET200 Binary File** is the path to the binary configuration file produced by the Siemens COM ET200 software. This file must match the network that the S-S card is actually connected to.

**Card I/O Port** specifies the base port address for the card. The jumpers on the card must be preset to the port address selected.

**Card Base Address** specifies the base address location of the card memory. At present, only one 5136-PFB card in a computer is supported. The default is D000. In Lookout, the Profibus DP object itself sets this on the card when it is loading the firmware.

**Network Init Timeout** specifies the number of milliseconds the card should wait while attempting to initialize the network before generating an alarm. The default is 1000 ms or one second.

**Card Scan Rate** is the rate at which the 5136-PFB card is scanned to look for fresh data. The default is 50 milliseconds.

## Profibus DP Data Members

All readable and writable members—inputs/outputs—are bundled with the object. Therefore, as soon as you create a Profibus DP object you immediately have access to all the object data members.

Data can be addressed either as bytes or words within slots, or as bits within these bytes or words. However, you cannot address a slot configured for digital input or output (as bytes) using word numbers. Similarly you cannot address a slot configured for analog input or output (as words) using byte numbers.

**Table 3-62.** Profibus DP Data Members

Data Member	Type	Read	Write	Description
CommFail	logical	yes	no	Object-generated signal that is on if, for any reason, Lookout cannot communicate with the Profibus card.
Slot0B0 – Slot127B63	numeric	yes	yes	This addresses data in a slot as a sequence of bytes.
Slot0B0.0 – Slot127B63.7	logical	yes	yes	This addresses individual bits while looking at a slot as a sequence of bytes.
Slot0W0 – Slot127W63	numeric	yes	yes	This addresses data in a slot as a sequence of words.
Slot0W0.0 – Slot127W63.15	logical	yes	yes	This addresses individual bits while looking at a slot as a sequence of words.

## Profibus DP Status Messages

### **Profibus SS Card not found**

The SS card was not found at the specified port and card base address. Check that the jumper settings on your card match the port address that you specified in the object creation dialog box. Also, check that the card is properly seated in the slot.

### **Profibus init failed**

The initialization of the Profibus SS card failed. This alarm is usually followed by an explanation of the reason for this failure.

### **Error accessing COM ET 200 binary file**

A file error occurred while attempting to open the COM ET 200 binary file.

### **Unconfigured Read Error**

A read was attempted on a data member that is not valid in the current Profibus DP network configuration.

### **Unconfigured Write Error**

A write was attempted on a data member that is not valid in the current Profibus DP network configuration.

### **Slave Error**

There was a problem with the particular slave device you are trying to access. This alarm is followed by a description of the problem with that slave device.



# ProfibusL2

---

ProfibusL2 is a protocol driver class for communicating with PLCs using Profibus Sinec-L2.

One of the problems with communicating with PLCs using Profibus Sinec-L2 is that there is no standard messaging system for transferring data. The Sinec L2 interface has a variety of message types available that you can use with applications as well as PLCs on a network. Lookout uses its own messaging system for transferring data and provides help for you to implement the PLC end of the messaging system.

## Lookout Messaging System

You should read the Siemens manual *Sinec-L2 Interface of the S5-95U Programmable Controller*, or some similar document that details a Sinec-L2 interface and how to write programs for your particular Sinec-L2 interface device.

Lookout uses two message types to receive and send all the data it needs. It uses the message type SRDh (Send and Request Data, high priority) to receive data from the PLC. To send data to the PLC, Lookout uses the message type SDAh (Send Data with Acknowledge, high priority).

All messages in Sinec-L2 are directed at specified SAPs (Service Access Points). You must program SAPs on each PLC to provide or accept the data you want to exchange with Lookout. You can use a given SAP only for reading or writing. Each poll request for a configured SAP reads *all* the data in that SAP. In the same way, if you are writing to a particular SAP, each write transfers all the data for that SAP to the PLC.

## Sample Program

Included in your copy of Lookout is a sample Siemens STEP5 program file, `LKTPFBST.S5D`. This file is placed in the `\sinecl2` directory under your Lookout directory during installation. This program contains an example of the logic necessary to create the Service Access Points (SAPs) for communications from a Simatic S5-95U to Lookout software using the Profibus protocol.

The program consists of one program block, three function blocks, three data blocks, and the modifications needed in OB1 and DB1 to successfully configure the Profibus communication link. This sample establishes two SAPs to the Profibus Layer 2 services of the PLC. Lookout uses the first

SAP, 34, to write values to the PLC. Lookout uses the second SAP, 35, when reading values from the PLC. You can read or write data in byte, word, or double word formats.

In order to install the example Profibus program, follow these steps:

**1. TRANSFER ALL BLOCKS TO THE CPU MEMORY**

This must include all PBs, FBs, and DBs.

**2. PROFIBUS CONFIGURATION**

The example configures SAP 34 and SAP 35. However, you may modify the program, if necessary, to customize your application.

**3. PROFIBUS EXECUTION**

Jump to PB 223 is required from OB1. An example of this jump is included in OB1 in the program.

**4. PROFIBUS DATA HANDLING**

The sample program uses DB 234, DB 235, and DB 236 to move data from the PLC to Lookout and from Lookout to the PLC. All data must be mapped to and from data blocks for Profibus communications. These data blocks also contain 8-byte headers used as a part of the Profibus configuration parameters. Again, you may modify these blocks if necessary. In addition, flag bytes above 200 are used by the example program, so you should avoid using them.

## Detailed Explanation of the Profibus Example Program

The example program employs the Layer 2 services of the Siemens Simatic S5-95U for the Profibus communications to Lookout. In particular, the program uses SRD and RUP\_MULTIPLE. The configuration of these services is described in detail in Chapter 8, *Data Transmission by Accessing Layer 2 Services*, of the *Sinec-L2 Interface of the S5-95U Programmable Controller Manual*.

### DB1 Configuration

The first step in configuring the S5-95U is to insert the correct Profibus parameters in DB1 of the PLC. You should employ the COM\_DB1 software, available from Siemens, when setting these parameters.

First, you must enter the SINEC L2 basic parameters. These parameters include the station address, baud rate, target rotation time, and more. The parameters must exactly match those used in configuring your SinecL2 object. You can find the defaults for these parameters in the example program where they are used.

Next you must configure the SINEC L2 layer 2 service. Here, you define the individual SAPs and designate a status byte for each SAP. SAPs used for writing data to the PLC must have a status byte allocated in the **Receive** area. SAPs used for reading data from the PLC must have a status byte allocated in both the **Send** and **Receive** areas.

You can define up to 23 SAPs, numbering from 33 to 54 and also including 64. The example program uses SAP 34 for writing data, and FW 204 as its status and length bytes. The program uses SAP 35 for reading data, with FW 200 and FW 202 used for the status and length bytes in the **Send** and **Receive** areas.

## Function Block Explanation

The example program contains three function blocks to handle the data transfer between the Profibus SAPs and the CPU internal memory. These blocks evaluate the status bits associated with each SAP, and send or receive the data when allowable.

Function Block FB 224 coordinates the data written from Lookout to the PLC. The CPU looks for an *indication* from the SAP that new data exists. If the receive is viable, the block performs a jump to FB 253, which is the integrated L2-REC function block. The block takes the data and writes it to the area specified by DBNR. The example uses DB 234, starting at DW 0 and continuing for an unknown wildcard length. The first 8 bytes of DB 234, DW 0 through DW 3, contain the header for the message. You must include this header in the data block for proper operation.

Function Blocks FB 223 and FB 225 handle the data Lookout is attempting to read from the PLC. FB 225 acts in the same way as FB 224, looking for an indication that the SAP has received a new request for data. FB 223 actually writes the data to the SAP using a jump to FB 252, the integrated L2-SEND function block. The data is taken from the area designated by DBNR. In this case, DB 235 is used by FB 223 and DB 236 is used by FB 225. The first 8 bytes act as a header to the message to follow, and must be set with specific parameters. In DB 235, DW 1 through DW 4 are used for the Send, and DW 128 through DW 131 are used for the Indication. In DB 236, DW 1 through DW 4 are used for the Indication. The parameters required in the data blocks are discussed in the *Sinec-L2 Interface of the S5-95U Programmable Controller Manual*.

Program Block PB 223 initiates the jumps to all the function blocks for the Profibus communications. You must add a jump to PB 223 in your OB 1 in order to start the communications.

Finally, all the program blocks and function blocks use bits of the **Send** and **Receive** status bytes in their logic. If you change these bytes in DB 1, the you must also change the associated logic accordingly.

## ProfibusL2 Requirements

To run the 32-bit version of this object, you must have Windows NT 3.51 or better, or Windows 95 loaded, and an S-S Technologies 5136-PFB card installed in the computer. Lookout automatically loads the firmware module when an object is created.

**Figure 3-33.** ProfibusL2 Configuration Parameters Dialog Box

**PollRate** is a numeric expression that determines how often to poll the device. Lookout then polls the device at the specified time interval. Normally, this is a simple time constant such as 0:01 (one second). See *Numeric Data Members* in Chapter 2, *How Lookout Works*, of the *Getting Started with Lookout* manual for further information on entering time constants.

**Poll** is a logical expression. When this expression changes from FALSE to TRUE, Lookout polls the device. You can use a simple expression like the signal from a pushbutton, or a complex algorithm.

**Communication alarm priority** determines the priority level of object-generated alarms (0 – 10).

**Retry attempts** specifies the consecutive number of times Lookout attempts to establish communications with a device if it is not getting a valid response. After it tries the number of **Retry attempts** specified, the Profibus L2 object generates an alarm.

**Card Memory Address** specifies the base address location of the card memory. At present, only one 5136-PFB card in a computer is supported. The default is D000. In Lookout, the Profibus object itself sets this on the card when it is loading the firmware.

**Base Port Address** specifies the base port address for the card. The jumpers on the card must be preset to the port address selected.

## PFB Card Settings

**Card Network Address** specifies the Profibus address for the card on the bus. The valid range is 0 to 126.

**PLC Network Address** specifies the Profibus address for the PLC on the bus. The valid range is 0 to 126.

**Network High Address** specifies the highest possible Profibus address possible on the bus. The valid range is 0 to 126.

**Token Rotation Time** specifies the target maximum token rotation time for the network in Tbits (bit times). The valid range is 256 to 16,777,215.

**Network Baud Rate** specifies the baud rate to be used on the network. The valid selections are shown in the selection box.

**Slot Time** specifies how long the card waits for a reply to a message, in Tbits. The valid range is 37 to 16,383.

**Idle Time1** specifies the time in Tbits that the card waits after it receives a reply, an acknowledge or a token message before sending a message. Range: 35 to 1023

**Idle Time2** specifies the time in Tbits that the card waits after sending an SDN (Send Data with no acknowledge) message before it sends again. Range: 35 to 1023

**Ready Time** specifies the time in Tbits that the card, after it sends a command, is ready to receive the ACK or response. It is also the time the card waits after receiving a command. The valid values range from 11 to 1023.

## ProfibusL2 Data Members

All readable and writable members (inputs/outputs), polling instructions, and so on, are bundled with the object. Therefore, as soon as you create a Profibus object you immediately have access to all the object data members (see data member list in Table 3-63).

Data is addressed using SAP numbers and, within a SAP, the byte, word or Dword number. For example, if SAP 33 is configured for reading, SAP33B200 refers to the 201st byte of that SAP. Similarly, SAP42DW10.20 refers to the 21st bit of the 11th Dword of SAP 42.

The legal SAPs used by the Lookout ProfiI2 driver range from 0 to 255. Each SAP may provide up to 242 bytes of data (0 – 241) which you can address either as bytes, 121 words, or 60 Dwords. The actual range of valid SAPs varies according to the device being addressed. You can address bits by appending a period and bit number after the byte number, word number, or Dword number.



**Note** Lookout protocol driver objects automatically generate an efficient read/write blocking scheme based on the inputs and outputs being used in your process file. You are not required to build your own I/O blocking table.

**Table 3-63.** ProfibusL2 Data Members

Data Member	Type	Read	Write	Description
CommFail	logical	yes	no	Object-generated signal that is on if, for any reason, Lookout cannot communicate with the Profibus card.
Poll	logical	no	yes	When this value transitions from FALSE to TRUE Lookout polls the device.

**Table 3-63.** ProfibusL2 Data Members (Continued)

<b>Data Member</b>	<b>Type</b>	<b>Read</b>	<b>Write</b>	<b>Description</b>
PollRate	numeric	no	yes	Lookout expression that determines the device polling frequency.
SAP0B0 – SAP255B241	numeric	yes	yes	This addresses all the data in the SAP as a sequence of bytes.
SAP0B0.0 – SAP255B241.7	logical	yes	yes	This addresses individual bits while looking at an SAP as a sequence of bytes.
SAP0DW0 – SAP255DW60	numeric	yes	yes	This addresses all the data in the SAP as a sequence of double words.
SAP0DW0.0 – SAP255DW60.31	logical	yes	yes	This addresses individual bits while looking at an SAP as a sequence of double words.
SAP0W0 – SAP255W120	numeric	yes	yes	This addresses all the data in the SAP as a sequence of words.
SAP0W0.0 – SAP0255W120.15	logical	yes	yes	This addresses individual bits while looking at an SAP as a sequence of words.
Update	logical	yes	no	Object-generated signal that pulses low each time it polls the device.

## ProfibusL2 Status Messages

### Profibus SS Card not found

The SS card was not found at the specified port and card base address. Check that the jumper settings on your card match the port address that you specified in the object creation dialog box. Also, check that the card is properly seated in the slot.

### Profibus SS Card timed out on message

The SS card did not respond within a reasonable time to the message sent by Lookout. This may mean that you have lost communication with the card. Try restarting Lookout to see if this fixes the problem. If the problem persists, call National Instruments for assistance.

# Reliance

Reliance is a protocol driver class Lookout uses for communicating with Reliance AutoMate controllers.

**Figure 3-34.** Reliance Definition Parameters Dialog Box



**Note** If you are developing your application without a PC-Link card installed in your computer, and do not know the settings in the target system, you can enter 250 for Port Address, 0 for Node ID, and 3 for Max Nodes. You can then create the Reliance object and correct the parameter values for the actual system later, if necessary.

**Interface** is the method the object uses to communicate with the Reliance PLCs. Currently, only the Reliance R-Net is supported, using the Reliance PC-Link card.

**PollRate** is a numeric expression that determines how often to poll the device. Reliance then polls the device at the specified time interval. Normally, this is a simple time constant such as 0:01 (one second). See *Numeric Data Members* in Chapter 2, *How Lookout Works*, of the *Getting Started with Lookout* manual for information on entering time constants.

**Poll** is a logical expression. When this expression changes from FALSE to TRUE, Lookout polls the device. You can use a simple expression like the signal from a pushbutton, or a complex algorithm.



**Communication alarm priority** determines the priority level of object-generated alarms (0 – 10).

**Retry attempts** specifies the consecutive number of times Lookout attempts to establish communications with a device if it is not getting a valid response. After it tries the number of **Retry attempts** specified, the object generates an alarm. See Chapter 3, *Serial Port Communication Service*, in the *Lookout Developer's Manual* for more information.

**Receive timeout** is the time delay Lookout uses in waiting for a response from a device before retrying the request.

The **Skip every...** setting instructs Lookout not to poll a device it has lost communication with on every scheduled poll. Instead, Lookout skips the device in the polling cycle accordingly. Once communications have been reestablished, the device is polled on its regular cycle.

## PC-Link Card Settings

**Port Address** is the I/O port address used to access the software module on the card. See your PC-Link card documentation for specific settings.

**Interrupt** identifies the interrupt (IRQ) setting of your PC-Link card. The card generates an interrupt recognized by Lookout any time it receives an response from the device.

**Node ID** is the node ID setting of the PC-Link card on the R-Net.

**Max Nodes** is the maximum number of nodes on the R-Net.

## Destination Settings

**Node ID** is the node ID on the R-Net setting of the AutoMate processor that controls the target AutoMate PLC.

**Slot ID** is the ID of the PLC rack slot in which the target AutoMate resides.

## Reliance Data Members

All readable and writable members (inputs/outputs), polling instructions, read/write blocking, serial port usage, and so on, are bundled with the object. Therefore, as soon as you create an Reliance object you immediately have access to all the object data members (see data member list).



**Note** Lookout protocol driver objects automatically generate an efficient read/write blocking scheme based on the inputs and outputs being used in your process file. You are not required to build your own I/O blocking table.

## Reliance Data Members

**Table 3-64.** Reliance Data Members (all addresses are in octal)

Data Member	Type	Read	Write	Description
0 – 157775	numeric	yes	yes	16-bit input registers encoded as unsigned binary integers ranging from 0 to 65,535.
0.0 – 15775.17	logical	yes	yes	Access individual bits in holding registers and read them as logical ON/OFF values. The least significant bit is 1; the most significant bit is 17.
CommFail	logical	yes	no	Driver-generated signal that is ON if Lookout cannot communicate with the device.
D0 – D157774	numeric	yes	yes	Wide data format ranges from –99,999,999 to +99,999,999.
Poll	logical	no	yes	When this expression transitions from FALSE to TRUE, Lookout polls the device.
PollRate	numeric	no	yes	Lookout expression that determines the polling frequency of the device.
Update	logical	yes	no	Driver-generated signal that pulses each time the driver polls the device.

## Reliance Status Messages

See your Reliance or PC-Link documentation for details of Reliance device generated messages.

## RKC F Series

RKC is a protocol driver class Lookout uses to communicate with RKC F Series devices using 7-bit ASCII serial communications.

With this driver you can read and write to all predefined data points allowed by a particular F Series model. When you create an RKC object, you have immediate access to all the object data members. See the data member tables for more information on data members for this object.

**Address** specifies which RKC F Series device you are communicating with. This number is between 0 and 31, and is set on the F Series device.

**PLC Model** specifies what model of RKC F Series device you are using. This driver supports the following models: REX-F400, REX-F700, and REX-F900.

**Serial port** specifies which COM port the object uses to communicate with the external device. This does not specify the communication type. Communication type is determined by the **Options»Serial Ports...** command.

**Data rate** indicates the baud rate Lookout uses to communicate with the hardware device. This setting should match the selection made on the physical device.

**Data bits** indicates the number of data bits Lookout uses to communicate with the hardware device. This setting should match the selection made on the physical device.

**Stop bits** indicates the number of stop bits Lookout uses to communicate with the hardware device. This setting should match the selection made on the physical device.

**Parity** indicates the parity that Lookout uses to communicate with the hardware device. This setting should match the selection made on the physical device.

**Phone number** specifies the number to be dialed if the selected serial port is configured for dial-up.

**PollRate** is a numeric expression that determines how often to poll the device. The object then polls the device at the specified time interval. Normally, this is a simple time constant such as 0:01 (one second). See *Numeric Data Members* in Chapter 2, *How Lookout Works*, of the *Getting Started with Lookout* manual for information on entering time constants.

**Poll** is a logical expression. When this expression changes from FALSE to TRUE, Lookout polls the device. You can use a simple expression like the signal from a pushbutton, or a complex algorithm.

**Communication alarm priority** determines the priority level of alarms generated by the RKC object. Such alarms are typically related to communications with the physical device.

**Retry attempts** specifies the consecutive number of times Lookout attempts to establish communications with a device if it is not getting a valid response. After it tries the number of **Retry attempts** specified, the RKC object generates an alarm and releases the COM port. See Chapter 3, *Serial Port Communication Service*, in the *Lookout Developer's Manual* for more information.

**Receive timeout** is the time delay Lookout uses in waiting for a response from a device before retrying the request.

The **Skip every...** setting instructs Lookout to not poll a device it has lost communication with on every scheduled poll. Instead, Lookout skips the device in the polling cycle. Once communications have been reestablished, the device is polled on its regular cycle.

## RKC Data Members

As with all Lookout drivers, you can access I/O points and other data through data members. The Lookout RKC object class currently supports the data members contained in the following tables, which are divided into groups according to their functionality.

**Table 3-65.** RKC Data Member Group

Parameter Group	Description
Measured Value Group	measured inputs and alarm status
Operation Mode Group	operation mode status
Memory Area and Set Value Group	set value (SV)
Parameter Group 10	measured input parameters
Parameter Group 11	remote setting input parameters
Parameter Group 12	output parameters
Parameter Group 13	auto-tuning bias parameters
Parameter Group 14	alarm 1 parameters
Parameter Group 15	analog output parameters
Parameter Group 16	positioning, proportioning, PID action parameters
Parameter Group 17	bar graph parameters
Parameter Group 20	input selection parameters
Parameter Group 21	setting parameters
Parameter Group 22	output action parameters
Parameter Group 23	alarm 2 parameters
Parameter Group 40	data lock parameters
Lookout data members	standard Lookout data members



**Note** For a more complete definition of the function of these data members, see your RKC F Series documentation.

Not all data members are valid for every F Series device. See your RKC documentation for which data members are valid for particular model numbers.

**Table 3-66.** Measured Value Group

<b>Data Member</b>	<b>Type</b>	<b>Read</b>	<b>Write</b>	<b>Description</b>
AA	logical	yes	no	First alarm status
AB	logical	yes	no	Second alarm status
AC	logical	yes	no	Heater break alarm status
B1	logical	yes	no	Burnout status
B2	logical	yes	no	Burnout status of feedback resistance input
M1	numeric	yes	no	Measured value input
M2	numeric	yes	no	Feedback resistance input
M3	numeric	yes	no	Current transformer input
MS	numeric	yes	no	Set value
O1	numeric	yes	no	Manipulated output
O2	numeric	yes	no	Cooling-side manipulated output
S2	numeric	yes	no	Remote set value

**Table 3-67.** Operation Mode Group

<b>Data Member</b>	<b>Type</b>	<b>Read</b>	<b>Write</b>	<b>Description</b>
C1	logical	yes	yes	Local/remote mode
E1	logical	yes	yes	Local/external memory area transfer
G1	logical	yes	yes	PID control/autotuning
J1	logical	yes	yes	Auto/manual mode
ON	numeric	yes	no	Manipulated output
RA	logical	yes	no	Local/computer mode
SR	logical	yes	yes	RUN/STOP mode
ZA	numeric	yes	yes	Control area

**Table 3-68.** Memory Area and Set Value Group

<b>Data Member</b>	<b>Type</b>	<b>Read</b>	<b>Write</b>	<b>Description</b>
A1:1 - A1:8	numeric	yes	yes	First alarm setting
A2:1 - A2:8	numeric	yes	yes	Second alarm setting
CA:1 - CA:8	numeric	yes	yes	Control response designation parameter
D1:1 - D1:8	numeric	yes	yes	Derivative constant
HH:1 - HH:8	numeric	yes	yes	Setting change rate limit
I1:1 - I1:8	numeric	yes	yes	Integral constant
P1:1 - P1:8	numeric	yes	yes	Proportional constant
P2:1 - P2:8	numeric	yes	yes	Cooling-side proportional band
S1:1 - S1:8	numeric	yes	yes	Set value
V1:1 - V1:8	numeric	yes	yes	Deadband

**Table 3-69.** Parameter Group 10 (Measured Input Parameters)

<b>Data Member</b>	<b>Type</b>	<b>Read</b>	<b>Write</b>	<b>Description</b>
DP	numeric	yes	yes	Low input cut-off
F1	numeric	yes	yes	Measured value first order lag filter
PB	numeric	yes	yes	Measured value bias

**Table 3-70.** Parameter Group 11 (Remote Setting Input Parameters)

<b>Data Member</b>	<b>Type</b>	<b>Read</b>	<b>Write</b>	<b>Description</b>
F2	numeric	yes	yes	Remote set value first order lag filter
RB	numeric	yes	yes	Remote set value bias
RR	numeric	yes	yes	Remote set value ratio

**Table 3-71.** Parameter Group 12 (Output Parameters)

Data Member	Type	Read	Write	Description
IV	numeric	yes	yes	Upper ON/OFF differential gap
IW	numeric	yes	yes	Lower ON/OFF differential gap
OE	numeric	yes	yes	Manual output at abnormality
OH	numeric	yes	yes	Manipulated output high limit
OL	numeric	yes	yes	Manipulated output low limit
OQ	numeric	yes	yes	Shortest cooling output on time
PH	numeric	yes	yes	Increase in output change rate limit
PL	numeric	yes	yes	Decrease in output change rate limit

**Table 3-72.** Parameter Group 13 (Auto-Tuning Bias Parameters)

Data Member	Type	Read	Write	Description
GB	numeric	yes	yes	Set value bias when autotuning is performed

**Table 3-73.** Parameter Group 14 (Alarm 1 Parameters)

Data Member	Type	Read	Write	Description
A3	numeric	yes	yes	Heater break alarm value
HA	numeric	yes	yes	First alarm differential gap
HB	numeric	yes	yes	Second alarm differential gap
TD	numeric	yes	yes	First alarm timer setting
TG	numeric	yes	yes	Second alarm timer setting



**Table 3-74.** Parameter Group 15 (Analog Output Parameters)

Data Member	Type	Read	Write	Description
HV	numeric	yes	yes	High limit of analog output range
HW	numeric	yes	yes	Low limit of analog output range
LA	numeric	yes	yes	Analog output type

**Table 3-75.** Parameter Group 16 (Positioning, Proportioning, PID Action Parameters)

Data Member	Type	Read	Write	Description
SY	numeric	yes	yes	Action selection at feedback resistance input break
V2	numeric	yes	yes	Neutral zone
VH	numeric	yes	yes	Open/close output differential gap

**Table 3-76.** Parameter Group 17 (Bar Graph Parameter)

Data Member	Type	Read	Write	Description
DA	logical	yes	yes	Bar graph display selection

**Table 3-77.** Parameter Group 20 (Input Selection Parameters)

Data Member	Type	Read	Write	Description
AV	numeric	yes	yes	High limit of abnormality
AW	numeric	yes	yes	Low limit of abnormality
WH	logical	yes	yes	High limit of abnormality action selection
WL	logical	yes	yes	Low limit of abnormality action selection
XH	logical	yes	yes	Square root extraction
XI	numeric	yes	yes	Measured value input type
XU	numeric	yes	yes	Decimal point position selection

**Table 3-77.** Parameter Group 20 (Input Selection Parameters) (Continued)

<b>Data Member</b>	<b>Type</b>	<b>Read</b>	<b>Write</b>	<b>Description</b>
XV	numeric	yes	yes	High limit of input programmable range
XW	numeric	yes	yes	Low limit of input programmable range

**Table 3-78.** Parameter Group 21 (Setting Parameters)

<b>Data Member</b>	<b>Type</b>	<b>Read</b>	<b>Write</b>	<b>Description</b>
SH	numeric	yes	yes	High limit of setting range
SL	numeric	yes	yes	Low limit of setting range
XL	logical	yes	yes	SV tracking selection
XR	numeric	yes	yes	Remote setting input type

**Table 3-79.** Parameter Group 22 (Output Action Parameters)

<b>Data Member</b>	<b>Type</b>	<b>Read</b>	<b>Write</b>	<b>Description</b>
SX	numeric	yes	yes	Start determination point
T0	numeric	yes	yes	Control output cycle setting
T1	numeric	yes	yes	Cooling-side output cycle setting
XE	logical	yes	yes	Direct/reverse action
XN	numeric	yes	yes	Action after power recovery setting

**Table 3-80.** Parameter Group 23 (Alarm 2 Parameters)

<b>Data Member</b>	<b>Type</b>	<b>Read</b>	<b>Write</b>	<b>Description</b>
XA	numeric	yes	yes	First alarm action
NA	logical	yes	yes	First alarm energized/de-energized
OA	numeric	yes	yes	First alarm action when measured value exceeds abnormality

**Table 3-80.** Parameter Group 23 (Alarm 2 Parameters) (Continued)

<b>Data Member</b>	<b>Type</b>	<b>Read</b>	<b>Write</b>	<b>Description</b>
WA	numeric	yes	yes	First alarm hold action
XB	numeric	yes	yes	Second alarm action
NB	logical	yes	yes	Second alarm energized/de-energized
OB	numeric	yes	yes	Second alarm action when measured value exceeds abnormality
WB	numeric	yes	yes	Second alarm hold action

**Table 3-81.** Parameter Group 40 (Data Lock Parameters)

<b>Data Member</b>	<b>Type</b>	<b>Read</b>	<b>Write</b>	<b>Description</b>
DH	logical	yes	yes	Operation RUN/STOP display lock
LK	numeric	yes	yes	Data lock level setting
LL	logical	yes	yes	Memory area lock

**Table 3-82.** Lookout Data Members

<b>Data Member</b>	<b>Type</b>	<b>Read</b>	<b>Write</b>	<b>Description</b>
CommFail	logical	yes	no	Object-generated signal that is ON if Lookout cannot communicate with the device(s).
Poll	logical	no	yes	When this value transitions from FALSE to TRUE, Lookout polls the device.
PollRate	numeric	no	yes	Lookout expression that determines the device polling frequency.
Update	logical	yes	no	Object-generated signal that pulses low each time it polls the device.

## RKC Status Messages

### No response within timeout period

Lookout received no response from a device within the **Receive timeout** period. The RKC object is able to use the COM port, but when it polls the device, it does not respond—as if it is not even there. If you have daisy-chained several devices, you have introduced an inherent delay. You may have to significantly increase **Receive timeout** (and **Poll Rate**) to ensure Lookout is allowing enough time to receive the expected response. This increase has nothing to do with the processing capabilities of Lookout. Rather it is based solely on **Data rate** and the number of devices on the chain. Also, verify your baud rate settings, cable connections, power, configuration settings, COM port settings, and polling addresses.

### Invalid BCC in response

Lookout has received a frame with an invalid block check character (BCC). Check the cabling or look for two or more devices with the same address.

### Invalid identifier in request

The request frame sent had an invalid identifier. This could possibly mean that you have requested an identifier that is not valid for your particular model in the RKC F Series. Check your model number carefully and read your RKC documentation to determine which identifiers are valid for which models.

### Garbled or invalid frame

Lookout has received a frame without format characters in their proper positions. Check the **Receive gap** setting.

### Numeric conversion failed

Lookout was unable to successfully convert ASCII data sent back from RKC into a number. Check the **Receive gap** setting.

### No acknowledgment for write frame

There was no response to the write frame just sent. This could possibly mean that you have requested an identifier that is not valid for your particular model in the RKC F Series. Check your model number carefully and read RKC documentation to determine which identifiers are valid for which models.

### RKC F Series models supported:

REX-F400, REX-F700, REX-F900

## S5\_3964

S5\_3964 is a protocol driver class Lookout uses to communicate with Siemens Simatic S5 PLCs using the 3964 or 3964R protocols.

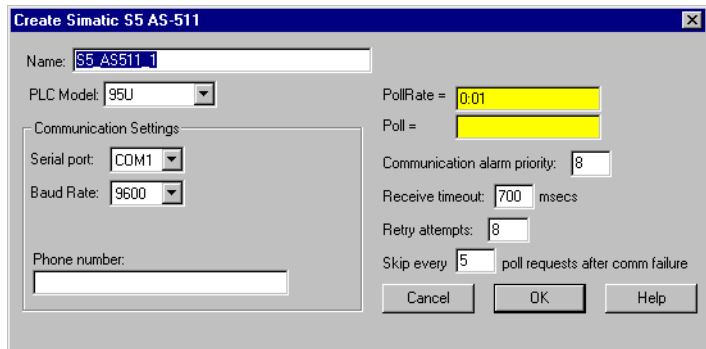

**Figure 3-35.** S5\_3964 Definition Parameters Dialog Box

**PLC Model** specifies the model of Simatic S5 CPU the object communicates with.

**Protocol** specifies the protocol used to communicate with the PLC, 3964 or 3964R.

**Serial port** specifies which port the object uses for communication to the PLC.

**Baud Rate** specifies the speed at which the object communicates with the PLC.

**Phone number** specifies the number to be dialed if the serial port setting is configured for dial-up. This number only applies to the individual protocol object.

**PollRate** is a numeric expression that determines how often to poll the device. Normally, this is a simple time constant such as 0:01 (one second). See *Numeric Data Members* in Chapter 2, *How Lookout Works*, of the *Getting Started with Lookout* manual for information on entering time constants.

**Poll** is a logical expression. When this expression changes from FALSE to TRUE, Lookout polls the device. You can use a simple expression like the signal from a pushbutton, or a complex algorithm.

**Communication alarm priority** determines the priority level of object-generated alarms (0 – 10).

**Receive timeout** is the time the object waits for a response from a device before retrying a request.

**Retry attempts** specifies the consecutive number of times Lookout attempts to establish communications with a device if it is not getting a valid response. After it tries the number of **Retry attempts** specified, the object generates an alarm and releases the COM port. See Chapter 3, *Serial Port Communication Service*, in the *Lookout Developer's Manual* for more information.

The **Skip every...** setting instructs the object that, in the event of a communications failure, to skip the next specified number of polls to the PLC before attempting to re-establish communications. Once communications have been re-established, the device is polled on its regular cycle.

## S5\_3964 Data Members

This protocol driver object contains a great deal of data. All readable and writable members (inputs/outputs), polling instructions, read/write blocking, serial port usage, and so on, are bundled with the object. As soon as you create a S5\_3964 object, you immediately have access to all the data members of that object.



**Note** Lookout protocol driver objects automatically generate an efficient read/write blocking scheme based on the inputs and outputs being used in your process file. You are not required to build your own I/O blocking table.

The suffixes for the PLC data members in Table 3-83 (KC, KF, and so on) follow the Siemens format for data suffixes. That is, KC for Counter format, KT for Timer format, KB for byte format, KF for fixed-point format, KG for floating-point format, and no suffix for those data members for which only one format is possible, such as bit fields, counters, and timers.

**Table 3-83.** S5\_3964 Data Members

<b>Data Member</b>	<b>Type</b>	<b>Read</b>	<b>Write</b>	<b>Description</b>
A0KC – A65535KC	numeric	yes	no	Absolute address interpreted as a counter.
A0KF – A65535KF	numeric	yes	no	Absolute address interpreted as a signed fixed-point.
A0KF – A65535KT	numeric	yes	no	Absolute address interpreted as a timer.
C0 – C255	numeric	yes	no	Counter.
CommFail	logical	yes	no	Object-generated signal that is ON if the object cannot communicate with the PLC.
DB1D0.0 – DB255D255.15	logical	yes	no	A bit in a Data Block word.
DB1DD0KF – DB255DD254KF	numeric	yes	yes	A double-word in an extended Data Block, interpreted as signed fixed-point.
DB1DD0KG – DB255DD254KG	numeric	yes	yes	A double-word in a Data Block interpreted as a Siemens floating point format.
DB1DL0KB – DB255DL255KB	numeric	yes	no	The unsigned left byte in a Data Block word.
DB1DR0KB – DB255DR255KB	numeric	yes	no	The unsigned right byte in a Data Block word.
DB1DW0KC – DB255DW255KC	numeric	yes	yes	Word in a Data Block interpreted as a counter.
DB1DW0KF – DB255DW255KF	numeric	yes	yes	Word in a Data Block interpreted as a signed fixed-point.
DB1DW0KT – DB255DW255KT	numeric	yes	yes	Word in a Data Block interpreted as a timer.
DX1D0.0 – DX255D255.15	logical	yes	no	A bit in an Extended Data Block word.

**Table 3-83.** S5\_3964 Data Members (Continued)

<b>Data Member</b>	<b>Type</b>	<b>Read</b>	<b>Write</b>	<b>Description</b>
DX1DD0KG – DX255DD254KG	numeric	yes	yes	A double-word in an Extended Data Block interpreted as a Siemens floating point format.
DX1DL0KB – DX255DL255KB	numeric	yes	no	The unsigned left byte in an Extended Data Block word.
DX1DR0KB – DX255DR255KB	numeric	yes	no	The unsigned right byte in an Extended Data Block word.
DX1DW0KC – DX255DW255KC	numeric	yes	yes	Word in an Extended Data Block interpreted as a counter.
DX1DW0KF – DX255DW255KF	numeric	yes	yes	Word in an Extended Data Block signed fixed-point.
DX1DW0KT – DX255DW255KT	numeric	yes	yes	Word in an Extended Data Block interpreted as a timer.
F0.0 – F255.7	logical	yes	no	A bit in Flag byte.
FD0KG – FD252KG	numeric	yes	no	A Flag double-word interpreted as a Siemens floating point format.
FW0KF – FW254KF	numeric	yes	no	A Flag word interpreted as a signed fixed-point.
FY0KB – FY255KB	numeric	yes	no	An unsigned Flag byte.
I0.0 – I127.7	logical	yes	no	A bit in a byte of the Input (PII) data area.
IB0KB – IB127KB	numeric	yes	no	A unsigned byte of the Input (PII) data area.
ID0KG – ID124KG	numeric	yes	no	A double-word of the Input (PII) data area interpreted as a Siemens floating point format.
IW0KF – IW126KF	numeric	yes	no	Word in of the Input (PII) data area interpreted as a signed fixed-point.
Poll	logical	no	yes	When this expression transitions from FALSE to TRUE, Lookout polls the device.



**Table 3-83.** S5\_3964 Data Members (Continued)

<b>Data Member</b>	<b>Type</b>	<b>Read</b>	<b>Write</b>	<b>Description</b>
PollRate	numeric	no	yes	Lookout expression that determines the device polling frequency.
Q0.0 – Q127.7	logical	yes	no	A bit in a byte of the Output (PIO) data area.
QB0KB – QB127KB	numeric	yes	no	An unsigned byte of the Output (PIO) data area.
QD0KG – QD124KG	numeric	yes	no	A double-word of the Output (PIO) data area interpreted as a Siemens floating point format.
QW0KF – QW126KF	numeric	yes	no	Word in of the Output (PIO) data area interpreted as a signed fixed-point.
RS0KC – RS511KC	numeric	yes	no	Word in the System data area interpreted as a signed fixed-point.
RS0KF – RS511KF	numeric	yes	no	Word in the System data area interpreted as a timer.
RS0KT – RS511KT	numeric	yes	no	Word in the System data area.
T0 – T255	numeric	yes	no	Timer.
Update	logical	yes	no	Object-generated signal that pulses low each time it polls the device

## S5\_3964 Alarms

### Object Alarms

The following alarms originate in the object, and are only generated after the object has retried the request the number of times specified by the **Retry attempts** parameter.

### No response from PLC

Lookout did not receive a response from the device within the **Receive timeout** period. The driver object is able to use the COM port, but when it polls the device, the device does not respond. You may have to increase **Receive timeout** to ensure Lookout is allowing enough time to receive the expected response. Also, verify your baud rate settings, cable connections, power, configuration settings, COM port settings, and polling addresses.

### **Unexpected response from PLC**

A response was received from the PLC, but not the response expected according to the protocol.

### **Bad frame**

A response frame was received from the PLC, but the frame is not valid according to the protocol. This is usually caused by a truncated frame. You may need to increase the **Receive Gap** setting in the **Options»Serial Ports...** dialog.

### **Bad BCC**

The BCC computed by the object for a received frame did not match the BCC in the frame.

### **PLC Alarms**

The following alarms originate in the PLC, and are generated immediately by the object. There are no retry attempts.

### **Illegal DB/DX number**

The Data Block (DB) or Extended Data Block (DX) number in a read/write request to a PLC was not valid for the PLC.

### **Synchronization error**

The PLC and S5\_3964 object are not synchronized within the protocol. This usually happens after the object is modified and a read/write request was interrupted. After generating the alarm, the S5\_3964 object attempts to resynchronize the protocol in the PLC.

# S5\_AS511

S5\_AS511 is a protocol driver class Lookout uses to communicate with Siemens Simatic S5 PLCs using the AS511 protocol.

**Figure 3-36.** S5\_AS511 Definition Parameters Dialog Box

**PLC Model** specifies the model of Simatic S5 CPU the object communicates with.

**Protocol** specifies the protocol used to communicate with the PLC, 3964 or 3964R.

**Serial port** specifies which port the object uses for communication to the PLC.

**Baud Rate** specifies the speed at which the object communicates with the PLC.

**Phone number** specifies the number to be dialed if the serial port setting is configured for dial-up. This number only applies to the individual protocol object.

**PollRate** is a numeric expression that determines how often to poll the device. Normally, this is a simple time constant such as 0:01 (one second). See *Numeric Data Members* in Chapter 2, *How Lookout Works*, of the *Getting Started with Lookout* manual for information on entering time constants.

**Poll** is a logical expression. When this expression changes from FALSE to TRUE, Lookout polls the device. You can use a simple expression like the signal from a pushbutton, or a complex algorithm.

**Communication alarm priority** determines the priority level of object-generated alarms (0 – 10).

**Receive timeout** is the time the object waits for a response from a device before retrying a request.

**Retry attempts** specifies the consecutive number of times Lookout attempts to establish communications with a device if it is not getting a valid response. After it tries the number of **Retry attempts** specified, the object generates an alarm and releases the COM port. See Chapter 3, *Serial Port Communication Service*, in the *Lookout Developer's Manual* for more information.

The **Skip every** setting instructs the object that, in the event of a communications failure, to skip the next specified number of polls to the PLC before attempting to re-establish communications. Once communications have been re-established, the device is polled on its regular cycle.

## S5\_AS511 Data Members

For the PLC data members in Table 3-84, all of the suffixes that start with K (KC, KF, and so on) follow the Siemens format for data suffixes. That is, KC for Counter format, KT for Timer format, KB for byte format, KF for fixed-point format, KG for floating-point format, and no suffix for those data members for which only one format is possible, such as bit fields, counters, and timers. The other three suffixes, F, D, and T have been added to allow reading and writing IEEE 32-bit floating point (F), IEEE 64-bit floating point (D), and Lookout time (T). See *Numeric Data Members* in Chapter 2, *How Lookout Works*, of the *Getting Started with Lookout* manual for information on Lookout time format.

**Table 3-84.** S5\_AS511 Data Members

Data Member	Type	Read	Write	Description
A0KB -A6535KB	numeric	yes	yes	Absolute address unsigned left byte in a data block word.
A0KC -A6535KC	numeric	yes	yes	Absolute address of a word in a data block interpreted as a counter.

**Table 3-84.** S5\_AS511 Data Members (Continued)

<b>Data Member</b>	<b>Type</b>	<b>Read</b>	<b>Write</b>	<b>Description</b>
A0KF -A6535KF	numeric	yes	yes	Absolute address of a word in a data block interpreted as a signed fixed-point.
A0KG -A6535KG	numeric	yes	yes	Absolute address of a word in a data block interpreted as a Siemens floating-point.
A0KT -A6535KT	numeric	yes	yes	Absolute address of a word in a data block interpreted as a Siemens time format.
CommFail	Logical	yes	no	Object-generated signal that is ON if the object cannot communicate with the PLC.
DB1D0.0 – DB255D255.15	Logical	yes	no	A bit in a Data Block word.
DB1DD0D – DB255DD254D	Numeric	yes	yes	64-bit in a Data Block interpreted as IEEE floating point format.
DB1DD0F – DB255DD254F	Numeric	yes	yes	32-bit in a Data Block interpreted as IEEE floating point format.
DB1DD0KF – DB255DD254KF	Numeric	yes	yes	Single-word in a Data Block interpreted as signed fixed-point.
DB1DD0KG – DB255DD254KG	Numeric	yes	yes	Double-word in a Data Block interpreted as Siemens floating point format.
DB1DL0KB – DB255DL255KB	Numeric	yes	no	The unsigned left byte in a Data Block word.
DB1DR0KB – DB255DR255KB	Numeric	yes	no	The unsigned right byte in a Data Block word.
DB1DW0KC – DB255DW255KC	Numeric	yes	yes	Word in a Data Block interpreted as a counter.
DB1DW0KF – DB255DW255KF	Numeric	yes	yes	Word in a Data Block interpreted as signed fixed-point.
DB1DW0KT – DB255DW255KT	Numeric	yes	yes	Word in a Data Block interpreted as Siemens time format.

**Table 3-84.** S5\_AS511 Data Members (Continued)

<b>Data Member</b>	<b>Type</b>	<b>Read</b>	<b>Write</b>	<b>Description</b>
DB1DW0T – DB255DW255T	Numeric	yes	yes	Word in a Data Block interpreted as Lookout time format.
Poll	Logical	no	yes	When this expression transitions from FALSE to TRUE, Lookout polls the device.
PollRate	Numeric	no	yes	Lookout expression that determines the device polling frequency.
Update	Logical	yes	no	Object-generated signal that pulses low each time it polls the device

## S5\_AS511 Alarms

### Object Alarms

The following alarms originate in the object, and are only generated after the object has retried the request the number of times specified by the Retry attempts parameter.

#### No response from PLC

Lookout did not receive a response from the device within the Receive timeout period. The driver object is able to use the COM port, but when it polls the device, the device does not respond. You may have to increase Receive timeout to ensure Lookout is allowing enough time to receive the expected response. Also, verify your baud rate settings, cable connections, power, configuration settings, COM port settings, and polling addresses.

#### Unexpected response from PLC

A response was received from the PLC, but not the response expected according to the protocol.

The BCC computed by the object for a received frame did not match the BCC in the frame.

## **PLC Alarms**

The following alarms originate in the PLC, and are generated immediately by the object. There are no retry attempts.

### **Illegal DB/DX number**

The Data Block (DB) number in a read/write request to a PLC was not valid for the PLC.

### **Invalid datablock word number**

The word number in a read/write request to a PLC was not valid for the specified Data Block (DB).

## Scan-Data Driver

Scan-Data is a protocol driver class that Lookout uses to communicate with Scan-Data LMX, SMR & M-systems RTUs using the Compressed ASCII Protocol.

Currently Lookout supports only versions B and C of the protocol.

**Serial port** specifies the COM port on the host computer that the Lookout object uses for communicating to the external device. This does not specify the communication type. Communication type is determined by the **Options»Serial Ports** command. See Chapter 3, *Serial Port Communication Service*, of the *Lookout Developer's Manual* for more information on configuring your serial ports for use with Lookout.

**Data rate, Parity, Data bits, and Stop bits** reference the settings on the hardware device.

**Phone** specifies the telephone number dialed if the selected serial port is configured for dial-up. This number only applies to the individual protocol object.

**PollRate** is a numeric expression that determines how often to poll the device. Lookout polls the device at the specified time interval. Normally, this is a simple time constant such as 0:01 (one second). See *Numeric Data Members* in Chapter 2, *How Lookout Works*, of the *Getting Started with Lookout* manual for information on entering time constants.



**Poll** is a logical expression. When this expression changes from FALSE to TRUE, Lookout polls the device. Use a simple expression like the signal from a pushbutton, or a complex algorithm.

**Communication alarm priority** determines the priority level of the alarms generated by this.

**Retry attempts** specifies the consecutive number of times Lookout attempts to establish communication with a device if it is not getting a valid response. After the specified number of **Retry attempts**, the object generates an alarm and begins to **Skip every n poll requests after comm failure**. Once Lookout reestablishes communications, it polls the device on its regular cycle, as defined by **PollRate**.

**Receive timeout** is the time delay Lookout waits for a response from a device before retrying the poll request.

The **Skip every** setting instructs Lookout not to poll a device that it has lost communication with on every scheduled poll. Instead, Lookout polls the device only once in the specified number of poll cycles. Once communication has been reestablished, the device is polled on the specified cycle.

## Scan-Data Data Members

**Table 3-85.** Scan-Data Data Members

Data Member	Type	Read	Write	Description
CommFail	logical	yes	no	Object-generated signal that is on if Lookout cannot communicate with the device.
OffHook	logical	no	yes	When TRUE, this flag instructs the Scan-Data object to retain exclusive use of its assigned communication port.
Poll	logical	no	yes	When this value transitions from FALSE to TRUE, Lookout polls the device.
PollRate	numeric	no	yes	Lookout expression that determines the device polling frequency.

**Table 3-85.** Scan-Data Data Members (Continued)

<b>Data Member</b>	<b>Type</b>	<b>Read</b>	<b>Write</b>	<b>Description</b>
Update	logical	yes	no	Object-generated signal that pulses low each time it polls the device.
AnalogInput1-99	Numeric	yes	no	Analog Input values between 0 and 9999.
AnalogOutput1-99	Numeric	yes	yes	Analog output values between 0 and 9999.
CommandOutput1-99	Logical	yes	yes	Relay driver outputs between 0 and 9999.
PulseAccInput1-99	Numeric	yes	no	Pulse Accumulator Inputs (counter) between 0 and 99999 .
StatusInput1-99	Logical	yes	no	Analog output values between 0 and 9999.

## Scan-Data Status Messages

Look out displays the following status messages for the Scan-Data driver object.

### **Start character not received.**

Check power supply and serial port wiring.

### **Unexpected protocol identifier returned by RTU.**

Check the protocol setting.

### **Invalid Address returned in frame.**

If you have more than one RTU connected to your computer and communicating with Lookout, make sure that the addressing for each RTU is correct.

### **Message Garbled - Bad CRC.**

May be caused by transmission line noise.

### **Unexpected data response length.**

May be caused by transmission line noise. Also make sure the model RTU is what is set in the driver object.

**No response from RTU.**

Make sure the RTU is online and functioning properly.

**Garbled Response received from RTU.**

May be caused by transmission line noise.

**Invalid Command received from RTU.**

If you have more than one RTU connected to your computer and communicating with Lookout, make sure that the addressing for each RTU is correct.

## Siemens S7\_HMI

S7\_HMI is a protocol driver class Lookout uses to communicate with Siemens S7-300 and S7-400 PLCs through a Siemens HMI adapter. It is not necessary to have an Applicom board installed in your computer to connect to this PLC.

**Serial port** specifies the COM port on the host computer that Lookout object uses for communicating to the external device. This does not specify the communication type. Communication type is determined by the **Options»Serial Ports** command. See Chapter 3, *Serial Port Communication Service*, of the *Lookout Developer's Manual* for more information on configuring your serial ports for use with Lookout.

**MPI Address (CPU)** specifies the particular CPU the object is to talk to.

**Baud rate** references the settings on the hardware device.

**Phone** specifies the telephone number dialed if the selected serial port is configured for dial-up. This number only applies to the individual protocol object.

**PollRate** is a numeric expression that determines how often to poll the device. Lookout polls the device at the specified time interval. Normally, this is a simple time constant such as 0:01 (one second). See *Numeric Data Members* in Chapter 2, *How Lookout Works*, of the *Getting Started with Lookout* manual for information on entering time constants.

**Poll** is a logical expression. When this expression changes from FALSE to TRUE, Lookout polls the device. Use a simple expression like the signal from a pushbutton, or a complex algorithm.

**Communication alarm priority** determines the priority level of the alarms generated by this object.

**Retry attempts** specifies the consecutive number of times Lookout attempts to establish communications with a device there is no valid response. After the specified number of **Retry attempts**, the object generates an alarm and begins to **Skip every *n* poll requests after comm failure**. Once Lookout reestablishes communication, it polls the device on the cycle defined by **PollRate**.

**Receive timeout** is the time delay Lookout waits for a response from a device before retrying the poll request.

The **Skip every** setting instructs Lookout not to poll a device it has lost communication with on every scheduled poll. Instead, Lookout polls the device only once in the specified number of poll cycles. Once communication has been reestablished, the device is polled on the specified cycle.

## Special Serial Port Configuration

Experienced users of Siemens hardware may want to make certain adjustments to serial port configuration to improve performance of an S7\_HMI system. This system tuning should only be attempted by users with experience and understanding of the hardware systems involved.

Using a text editor, create a .INI file in your Lookout directory titled S7\_HMI.INI. Enter settings in a section for each COM port you want to configure using the following keys.

MPIBaud	Specifies the speed at which the MPI Network is operating. The only setting is for 9600. No other selections are possible.
HighestMPI	The highest possible MPI address for any device on the Network. The range for this setting is from 0 to 126; the default is 31.
PanelMPI	The MPI address assigned to the hardware adapter that is being used to talk to the network. The range for this setting is from 0 to the HighestMPI setting.

A typical file might resemble the following example.

```
[COM1]
MPIBaud = Auto
HighestMPI = 31
PanelMPI = 30

[COM2]
MPIBaud = 9600
HighestMPI = 68
PanelMPI = 34
```

## Siemens S7\_HMI Data Members

**Table 3-86.** Siemens S7\_HMI Data Members

Data Member	Type	Read	Write	Description
QB0-QB65535	numeric	yes	yes	Output bytes.
QBS0-QBS65535	numeric	yes	yes	Signed output bytes.
QW0-QW65534	numeric	yes	yes	Output words.
QWS0-QWS65534	numeric	yes	yes	Signed output words.
CommFail	logical	yes	no	Object-generated signal that is ON if Lookout cannot communicate with the devices.
DB0.DBD0-DB32767.DBD65532	numeric	yes	yes	Double words in DB.
DB0.DBDS0-DB32767.DBDS65532	numeric	yes	yes	Signed double words in DB.
DB0.DBW0-DB32767.DBW65534	numeric	yes	yes	Words in DB.
DB0.DBWS0-DB32767.DBWS65534	numeric	yes	yes	Signed words in DB.
DB0.DBB0-DB32767.DBB65535	numeric	yes	yes	Bytes in DB.
DB0.DBBS0-DB32767.DBBS65535	numeric	yes	yes	Signed bytes in DB.
I0.0-I65535.7	logical	yes	no	Input bits.

**Table 3-86.** Siemens S7\_HMI Data Members (Continued)

<b>Data Member</b>	<b>Type</b>	<b>Read</b>	<b>Write</b>	<b>Description</b>
IB0-IB65535	numeric	yes	yes	Input bytes.
IBS0-IBS65535	numeric	yes	yes	Signed input bytes.
IW0-IW65534	numeric	yes	yes	Input words.
IWS0-IWS65534	numeric	yes	yes	Signed input words.
M0.0-M65535.7	logical	yes	yes	Bits in flag bytes.
MB0-MB65535	numeric	yes	yes	Flag bytes.
MBS0-MBS65535	numeric	yes	yes	Signed flag bytes.
MD0-MD65532	numeric	yes	yes	Double words in flag bytes.
MDS0-MDS65532	numeric	yes	yes	Signed double words in flag bytes.
MW0-MW65534	numeric	yes	yes	Words in flag bytes.
MWS0-MWS65534	numeric	yes	yes	Signed words in flag bytes.
OffHook	logical	no	yes	When TRUE, this flag instructs the Scan-Data object to retain exclusive use of its assigned communication port. .
Poll	logical	no	yes	When this value transitions from FALSE to TRUE, Lookout polls the device.
PollRate	numeric	no	yes	Lookout expression that determines the device polling frequency.
Update	logical	yes	no	Goes FALSE when a poll starts and TRUE when a poll completes.

## Siemens S7\_HMI Status Messages

There are many alarms that can originate in the Siemens HMI adapter. Lookout passes the text of these alarms to the alarms window. For more information on Siemens alarms, consult your Siemens documentation.

### No response from PLC

Lookout received no response from the device within the **Receive timeout** period. The object was able to establish a connection, but the device did not

respond to the sent message. Significantly increase **Receive timeout** and **Poll Rate** to ensure Lookout allows enough time to receive the expected response. Also, verify cable connections, serial port wiring, power supply, configuration settings, and IP settings.

### **Unexpected response from PLC**

A response was received from the PLC, but it was not the response expected according to the protocol.

### **Bad frame**

A response frame was received from the PLC, but the frame is not valid according to the protocol. This is usually caused by a truncated frame. Increase the **Receive Gap** setting in the **Options»Serial Ports** dialog box.

### **Bad BCC**

The BCC computed by the object for a received frame did not match the BCC in the frame.

### **Unable to start MPI Network**

The HMI adapter did not recognize the start command that starts the network.



# SiemensTI505

SiemensTI505 is an Ethernet protocol driver object class Lookout uses to communicate with Siemens SIMATIC TI505 PLCs that are equipped with CP1431 NIMs. This driver is often referred to as Siemens H1.

Designed using the SINEC TF software library, this object class uses the SINEC H1 protocol and fully conforms to the application layer of the Siemens SINEC H1-TF protocol stack.

Your PC must be equipped with a Siemens CP 1413 Ethernet communications card and Siemens TF-NET 1413 software. See [Configuring HI-TF](#) in this section for instructions on setting up your H1 driver.

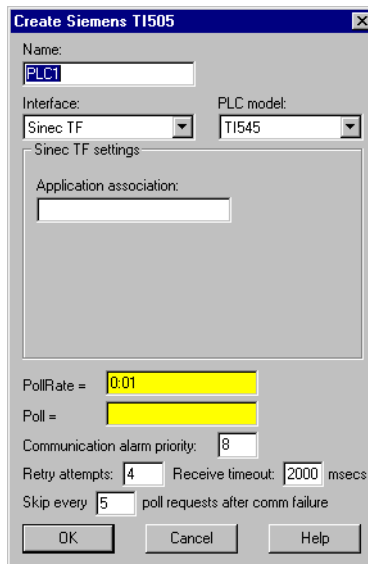

**Figure 3-37.** SiemensTI505 Definition Dialog Box

**PLC Model** specifies the PLC model number for the requested device. The list includes SIMATIC TI545, TI555 and TI565 PLCs.

**Application association** identifies an application name that you define using the `SINEC Com1413t.exe` program. This name identifies the physical device that your object represents. See [Configuring HI-TF](#) in this section for more information.

**PollRate** is a numeric expression that determines how often to poll the device. SiemensTI505 then polls the device at the specified time interval. Normally, this is a simple time constant such as 0:01 (one second). See *Numeric Data Members* in Chapter 2, *How Lookout Works*, of the *Getting Started with Lookout* manual for more information on entering time constants.

**Poll** is a logical expression. When this expression changes from FALSE to TRUE, Lookout polls the device. You can use a simple expression like the signal from a pushbutton, or a complex algorithm.

**Retry attempts** specifies the consecutive number of times Lookout attempts to establish communications with a device if it is not getting a valid response. After it tries the number of **Retry attempts** specified, the object generates an alarm and releases the COM port. See Chapter 3, *Serial Port Communication Service*, in the *Lookout Developer's Manual* for more information.

**Receive timeout** is the time delay Lookout uses in waiting for a response from a device before retrying the request.

**Communication alarm priority** determines the priority level of alarms generated by the SiemensTI505 object.

The **Skip every \_\_\_ polls** setting instructs Lookout not to poll a device it has lost communication with on every scheduled poll. Instead, Lookout skips the device in the polling cycle accordingly. Once communications have been reestablished, the device is polled on its regular cycle.

## Configuring HI-TF

Install the Siemens TF-NET1413 MSDOS/Windows driver configuration software, including the COML 1413 TF configuration tool.

Configure the CP1413 Ethernet MAC address, memory map, and other settings by executing the following program from DOS (not Windows):

```
c:\sinec\bin\netinst.exe.
```

This creates a text file called `C:\SINEC\DATA\DOS_conf.dat` that stores the configuration parameters. You can later edit this file to change card settings in lieu of executing the install program.

If you are using a memory manager such as EMM386, add a memory exclude statement to your computer `CONFIG.SYS` file. For example, enter:

```
DEVICE=C:\WINDOWS\EMM386.EXE X=D000-DFFF
```

The CP 1413 Ethernet card uses 64 Kb of dual-ported RAM. Possible start addresses are D0000 and E0000.



**Note** Be sure to verify that no other drivers are mapped to the selected memory location.

From Windows, run `C:\SINEC\COM\Com1413t.exe` (the three-pawn icon) and configure the PLC name/address database that you download later to the CP 1413 card during system startup. Create a database file called `STARTUP`, and save it in the `C:\SINEC\DATA` directory.

This program creates two files, with your database represented by `startup.ldb` and `startup.txt`. These files contain the application association names that you need for each PLC.



**Note** There is a line of text in `DOS_CONF.DAT` that points to `STARTUP.LDB`. To use a different path or filename for your `.ldb` file, modify `DOS_CONF.DAT` to point to the file you create.

From Windows, activate `C:\SINEC\H1\H1.exe` (the single pawn icon) to create an H1 configuration file. Then, using the serial port on the NIM, download the configuration file to the H1 NIM in the PLC.

You must enter a unique Ethernet address and application association that matches one stored in the `.LDB` file. Also be sure that the Local TSAP and Remote TSAP values match exactly with the `.LDB` settings, except the Local TSAP and Remote TSAP values are swapped.

Create one H1 configuration file for each NIM in each PLC.



**Note** Application Association, Local TSAP, Remote TSAP, and just about everything else in the Siemens software is case sensitive.

Download the configuration to each NIM through the serial port on the NIM.

Edit your `AUTOEXEC.BAT` file and add the following command to the end of the file—but prior to any `WIN` command):

```
CALL C:\SINEC\BIN\STARTCP.BAT
```

Reboot your computer.

Within Lookout, create a SIEMENSTI505 object for each PLC using the appropriate Application Association. You are now ready to access PLC variables in Lookout.

## SiemensTI505 Data Members

Protocol driver objects contain a great deal of data. All readable and writable members (inputs/outputs), polling instructions, read/write blocking, serial port usage, and so on, are bundled with the object. Therefore, as soon as you create a SiemensTI505 object you immediately have access to all the object data members (see data member list in Table 3-87).



**Note** Lookout protocol driver objects automatically generate an efficient read/write blocking scheme based on the inputs and outputs being used in your process file. You are not required to build your own I/O blocking table.

**Table 3-87.** SiemensTI505 Data Members

Data Member	Type	Read	Write	Description
AACK1 – AACK32000	numeric	yes	yes	(Analog Alarm) Alarm acknowledge flags
AADB1 – AADB32000	numeric	yes	yes	(Analog Alarm) Deadband
ACF1 – ACF32000	numeric	yes	yes	(Analog Alarm) Alarm C-flags
ACFH1 – ACFH32000	numeric	yes	yes	(Analog Alarm) Alarm C-flags most significant word
ACFL1 – ACFL32000	numeric	yes	yes	(Analog Alarm) Alarm C-flags least significant word
AERR1 – AERR32000	numeric	yes	yes	(Analog Alarm) Alarm error
AHA1 – AHA32000	numeric	yes	yes	(Analog Alarm) High alarm limit
AHHA1 – AHHA32000	numeric	yes	yes	(Analog Alarm) High high alarm limit
ALA1 – ALA32000	numeric	yes	yes	(Analog Alarm) Low alarm limit
ALLA1 – ALLA32000	numeric	yes	yes	(Analog Alarm) Low low alarm limit
AODA1 – AODA32000	numeric	yes	yes	(Analog Alarm) Orange deviation limit

**Table 3-87.** SiemensTI505 Data Members (Continued)

<b>Data Member</b>	<b>Type</b>	<b>Read</b>	<b>Write</b>	<b>Description</b>
APV1 – APV32000	numeric	yes	yes	(Analog Alarm) Process variable
APVH1 – APVH32000	numeric	yes	yes	(Analog Alarm) Process variable high limit
APVL1 – APVL32000	numeric	yes	yes	(Analog Alarm) Process variable low limit
ARCA1 – ARCA32000	numeric	yes	yes	(Analog Alarm) Rate of change limit
ASP1 – ASP32000	numeric	yes	yes	(Analog Alarm) Setpoint
ASPH1 – ASPH32000	numeric	yes	yes	(Analog Alarm) Setpoint high limit
ASPL1 – ASPL32000	numeric	yes	yes	(Analog Alarm) Setpoint low limit
ATS1 – ATS32000	numeric	yes	yes	(Analog Alarm) Sample rate
AVF1 – AVF32000	numeric	yes	yes	(Analog Alarm) Alarm flags
AYDA1 – AYDA32000	numeric	yes	yes	(Analog Alarm) Yellow deviation limit
C1 – C32000	logical	yes	yes	Control Registers
CommFail	logical	yes	no	Driver-generated signal that is ON if Lookout cannot communicate with the device for whatever reason
DCC1 – DCC32000	numeric	yes	no	Drum current count
DSC1 – DSC32000	numeric	yes	yes	Drum step current
DSP1 – DSP32000	numeric	yes	yes	Drum step preset
K1 – K32000	numeric	yes	yes	K-memory unsigned 16-bit integer value ranging from 0 to 65535
K1. – K32000.	numeric	yes	yes	K-memory 32-bit IEEE floating point value
K1D – K32000D	numeric	yes	yes	K-memory 32-bit unsigned integer value
K1S – K32000S	numeric	yes	yes	K-memory signed 16-bit integer value ranging from –32768 to 32767
LACK1 – LACK32000	numeric	yes	yes	(Loop) Alarm Acknowledge Flags

**Table 3-87.** SiemensTI505 Data Members (Continued)

<b>Data Member</b>	<b>Type</b>	<b>Read</b>	<b>Write</b>	<b>Description</b>
LADB1 – LADB32000	numeric	yes	yes	(Loop) Deadband
LCF1 – LCF32000	numeric	yes	yes	(Loop) C-flags
LCFH1 – LCFH32000	numeric	yes	yes	(Loop) C-flags most significant word
LCFL1 – LCFL32000	numeric	yes	yes	(Loop) C-flags least significant word
LERR1 – LERR32000	numeric	yes	no	(Loop) Error
LHA1 – LHA32000	numeric	yes	yes	(Loop) High alarm limit
LHHA1 – LHHA32000	numeric	yes	yes	(Loop) High high alarm limit
LKC1 – LKC32000	numeric	yes	yes	(Loop) Gain
LKD1 – LKD32000	numeric	yes	yes	(Loop) Derivative gain
LLA1 – LLA32000	numeric	yes	yes	(Loop) Low alarm limit
LLLA1 – LLLA32000	numeric	yes	yes	(Loop) Low low alarm limit
LM1 – LM32000	numeric	yes	yes	(Loop) Mode
LMN1 – LMN32000	numeric	yes	yes	(Loop) Output
LMX1 – LMX32000	numeric	yes	yes	(Loop) Bias
LODA1 – LODA32000	numeric	yes	yes	(Loop) Orange deviation limit
LPV1 – LPV32000	numeric	yes	yes	(Loop) Process variable
LPVH1 – LPVH32000	numeric	yes	yes	(Loop) Process variable high limit
LPVL1 – LPVL32000	numeric	yes	yes	(Loop) Process variable low limit
LRCA1 – LRCA32000	numeric	yes	yes	(Loop) Rate of change limit
LRSF1 – LRSF32000	numeric	yes	yes	(Loop) Ramp/Soak status flags
LS1 – LS32000	numeric	yes	no	(Loop) Status
LSP1 – LSP32000	numeric	yes	yes	(Loop) Setpoint
LSPH1 – LSPH32000	numeric	yes	yes	(Loop) Setpoint high limit
LSPL1 – LSPL32000	numeric	yes	yes	(Loop) Setpoint low limit
LTD1 – LTD32000	numeric	yes	yes	(Loop) Rate
LTI1 – LTI32000	numeric	yes	yes	(Loop) Reset

**Table 3-87.** SiemensTI505 Data Members (Continued)

<b>Data Member</b>	<b>Type</b>	<b>Read</b>	<b>Write</b>	<b>Description</b>
LTS1 – LTS32000	numeric	yes	yes	(Loop) Sample rate
LVF1 – LVF32000	numeric	yes	yes	(Loop) V-flags
LYDA1 – LYDA32000	numeric	yes	yes	(Loop) Yellow deviation limit
Poll	logical	no	yes	When this value transitions from FALSE to TRUE, the Lookout object polls the device
PollRate	numeric	no	yes	Specifies the frequency at which the Lookout object polls the device
TCC1 – TCC32000	numeric	yes	yes	(Analog Alarm) Timer/counter current
TCP1 – TCP32000	numeric	yes	yes	(Analog Alarm) Timer/counter preset
Update	logical	yes	no	Driver-generated signal that pulses each time the driver polls the device
V1 – V32000	numeric	yes	yes	V-memory unsigned 16-bit integer value ranging from 0 to 65535
V1. – V32000.	numeric	yes	yes	V-memory 32-bit IEEE floating point value
V1D – V32000D	numeric	yes	yes	V-memory 32-bit unsigned integer value
V1S – V32000S	numeric	yes	yes	V-memory signed 16-bit integer value ranging from –32768 to 32767
WX1 – WX32000	numeric	yes	no	Word Image Inputs—16-bit values that typically range from 6400 – 32000 for 4 – 20 mA signals, and 0 – 32000 for 0 – 5V signals.
WY1 – WY32000	numeric	yes	yes	Word Image Outputs—16-bit values that typically range from 6400 – 32000 for 4 – 20 mA signals, and 0 – 32000 for 0 – 5V signals.

**Table 3-87.** SiemensTI505 Data Members (Continued)

<b>Data Member</b>	<b>Type</b>	<b>Read</b>	<b>Write</b>	<b>Description</b>
X1 – X32000	logical	yes	no	Discrete Inputs—unassigned Xs may be used as control registers
Y1 – Y32000	logical	yes	yes	Discrete Outputs—same memory space as Discrete Inputs, so X37 references the same point as Y37. Unassigned Ys may be used as control registers

## SiemensTI505 Status Messages

The following alarms are SINEC error codes returned by the Siemens software. For more detailed information, consult the Siemens SINEC TF documentation.

- **cannot initialize Sinec TF service**
- **hardware error**
- **invalid address**
- **invalid app. assoc. name: xxxx**
- **more than one object using same app. assoc.**
- **no more space in PDU**
- **no response**
- **no response (reconnecting)**
- **not available at times**
- **object access not allowed**
- **object attribute inconsistent**
- **object does not exist**
- **object not defined**
- **object now invalid**
- **type not supported**
- **type/alt acc. not consistent**



# Sixnet

Sixnet is a protocol driver object class Lookout uses to communicate with Sixnet IOMUX RTUs (remote terminal units), Versamux RTUs, and DIN rail-mounted Sixtrak I/O modules.

The Lookout Sixnet object class establishes an interface to the Sixnet Control Room software using direct DLL calls (not DDE). Using this seamless connection between programs, Lookout can communicate with Sixnet devices through your serial port (RS-232 or RS-422/485), through Ethernet, or RTUnet.



**Note** This protocol driver object class requires Version 1.0 or later of Sixnet Control Room I/O Map software, and Version 3.5 build 15 (or later) of Lookout.

Create one Lookout Sixnet object for each station you define in the Control Room software. In order to make Sixtags names correspond as closely as possible to Lookout alias names, you should name the Lookout objects using the eight-letter prefixes of the Sixnet stations.

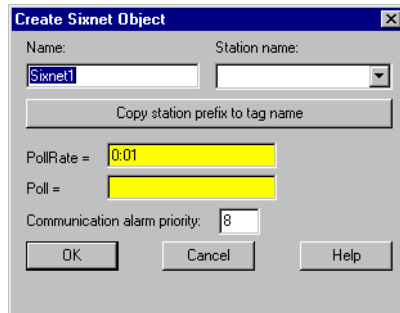

**Figure 3-38.** Sixnet Configuration Parameters Dialog Box

**Station name** is a pull-down list box of all stations defined in the Control Room software. Select the station that you want the object to represent.

**PollRate** is a numeric expression that specifies how often Lookout polls the Control Room software. Normally, this is a simple time constant such as 0:01 (one second), but you may choose to make this a complex expression, making the **PollRate** change dynamically based on criteria that you specify. See *Numeric Data Members* in Chapter 2, *How Lookout Works*, of the *Getting Started with Lookout* manual for information on entering time constants and variables.

**Poll** is a logical expression. When this expression changes from FALSE to TRUE, Lookout polls the device. You can use a simple expression like the signal from a pushbutton, or a complex algorithm.

**Communication alarm priority** determines the priority level of alarms generated by the Lookout Sixnet object. Such alarms are typically related to DLL handshaking with the Control Room software.

## Sixnet Data Members

A Sixnet object represents all values within a given station; therefore, it can contain a great deal of data. The object can read and write all possible data point types, including predefined and user-defined I/O types. When you create a Sixnet object, you have immediate access to all data within the assigned station (see *Sixnet Data Members* in Table 3-88).

Each register in the Sixnet I/O Map corresponds to a data member within the Lookout Sixnet object. The register I/O type number and address are encoded into the name of the data member. Predefined I/O type numbers correspond with Lookout data member prefixes as follows.

I/O Type Number	Data Member Prefix
0	AI (Analog In)
1	AO (Analog Out)
10	DI (Discrete In)
11	DO (Discrete Out)
20	LongIn
21	LongOut
22	FloatIn
23	FloatOut

For user-defined I/O types, the Sixnet I/O type number is specified by the name of the Lookout data member which takes the following form:

<DataType><ioTypeNumber>:<Address>

where <DataType> is Bit, Byte, Short, Word, Long, Float, or Double; <ioTypeNumber> is a number between 0 and 126 inclusive; and <Address> is a number whose legal range depends on the data type. Thus the Lookout

point `Sixnet1.Word33:99` corresponds to the hundredth register with I/O type number 33 for the station with name `Sixnet1.Station`. The register is read as a word (that is, an unsigned 16-bit number).

You can use any data type with any I/O type number in Lookout. This means that you can read a long (32-bit signed number) from two consecutive analog registers. This makes it very easy to get the value of a 32-bit counter that is stored in consecutive 16-bit registers in a PLC. For example, the data member `Long0:7` would correspond to analog inputs `AI7` and `AI8` and it would be interpreted as a signed, 32-bit register. This capability also means that you have the choice of reading an analog value as either a signed value (using `AI0` or `Short0:0`) or as an unsigned value (using `Word0:0`).



**Note** Writing a bit to an analog register sets that analog value to 0 or 1. It does not set just one of the bits to 0 or 1.

**Table 3-88.** Sixnet Data Members

Data Member	Type	Read	Write	Description
AI0 – AI32499	numeric	yes	yes	Analog input encoded as a 16-bit signed integer ranging from –32768 to +32767
AO0 – AO32499	numeric	yes	yes	Analog output encoded as a 16-bit signed integer ranging from –32768 to +32767
Bit0:0 – Bit126:64999	logical	yes	yes	User-defined discrete I/O (TRUE or FALSE)
Byte0:0 – Byte126:64999	numeric	yes	yes	User-defined register encoded as an 8-bit unsigned integer ranging from zero to 255
CommFail	logical	yes	no	Driver-generated signal that is ON if Lookout cannot communicate with the device for whatever reason
DI0 – DI64999	logical	yes	yes	Discrete input (TRUE or FALSE)
DO0 – DO64999	logical	yes	yes	Discrete output (TRUE or FALSE)

**Table 3-88.** Sixnet Data Members (Continued)

<b>Data Member</b>	<b>Type</b>	<b>Read</b>	<b>Write</b>	<b>Description</b>
Double0:0 – Double126:8124	numeric	yes	yes	User-defined I/O referring to 4 consecutive registers encoded as a single 64-bit floating point value
Float0:0 – Float126:16299	numeric	yes	yes	User-defined register pair encoded as a 32-bit IEEE floating point value
FloatIn0 – FloatIn16299	numeric	yes	yes	32-bit IEEE floating point value —reads two adjacent registers as a single 32-bit floating point value
FloatOut0 – FloatOut16299	numeric	yes	yes	32-bit IEEE floating point value —writes two adjacent registers as a single 32-bit floating point value
Long0:0 – Long126:16299	numeric	yes	yes	User-defined register pair encoded as a signed 32-bit long integer. Lookout reads two adjacent registers as a single 32-bit number ranging from –2147483648 to +2147483647.
LongIn0 – LongIn16299	numeric	yes	yes	Long input encoded as a signed 32-bit long integer. Lookout reads two adjacent registers as a single 32-bit number ranging from –2147483648 to +2147483647.
LongOut0 – LongOut16299	numeric	yes	yes	Long output encoded as a signed 32-bit long integer. Lookout writes two adjacent registers as a single 32-bit number ranging from –2147483648 to +2147483647.
Poll	logical	no	yes	When this value transitions from FALSE to TRUE, Lookout polls the device.
PollRate	numeric	no	yes	Lookout expression that determines the device polling frequency.
Short0:0 – Short126:32499	numeric	yes	yes	User-defined register encoded as 16-bit signed integer ranging from –32767 to +32768

**Table 3-88.** Sixnet Data Members (Continued)

Data Member	Type	Read	Write	Description
Station	text	yes	no	Station name (such as, Local Computer)
Update	logical	yes	no	Driver-generated signal that pulses each time the driver polls the device
Word0:0 – Word126:32499	numeric	yes	no	User-defined register encoded as 16-bit unsigned integer ranging from 0 to 65535

## Importing Sixtags Database

With the Sixnet Lookout object you can take advantage of Sixnet's Sixtags database. After you create at least one Sixnet object, the Sixnet class adds a menu selection (**Import Sixtags database**) to the Lookout **Options** menu. Use this menu command to import a set of aliases for one or more stations.

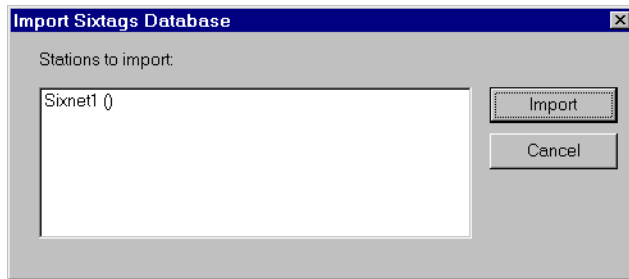

When you select the menu command, a dialog box appears, listing all of the Lookout Sixnet objects—giving their names and corresponding station names. From the dialog box, select one or more station names and click on Import. Notice that spaces in the Sixtags names are replaced by underscores. You can re-import name files as your Sixtags data is modified, and Lookout readjusts the aliased tag names automatically, in real time.

## Sixnet Status Messages

### **Unable to load Sixnet IOMAP library: iodbase.dll**

The Sixnet software is not installed—Lookout cannot find the `iodbase.dll` library. Make sure that you have installed the Control Room software properly. This should put the `iodbase.dll` library into the `\WINDOWS\SYSTEM` directory.

### **No Sixnet configuration currently loaded**

The Sixnet I/O Map software is not running yet. Use the Sixnet I/O Map program to open and run a project file. According to the Sixnet I/O Map help file, your DLL must be loaded and scanning before Lookout can control I/O. The easiest way to load the DLL and start scanning is to run the Control Room Power Switch. You could also select the **Run** command from the **Control** menu in the Sixnet I/O Map.

### **Station <name> is not on line**

Sixnet reports that the named station is not on line. Lookout might still be able to read from and write to registers for that station, but the updates will not be propagated to the remote device.

**Read error (<station name>, type <type number>, address <address>)**

**Write error (<station name>, type <type number>, address <address>)**

One of the following reasons will be given:

- Address out of range
- Bad station, address, or type number
- Bad type number

# SquareD

Lookout uses the SquareD object class to communicate with the SquareD family of SCP PLCs. These include the SCP-1xx, 3xx, 4xx, 5xx, 6xx, and 7xx series. Lookout can interface to SquareD PLCs through either a serial interface or a SY/MAX interface. The SY/MAX interface supports both SY/MAX and net-to-net communication modes.

The screenshot shows the 'Create Square D' dialog box with the following settings:

- Name: SquareD1
- Model: SCP-4xx
- Route: (empty)
- Interface: Serial
- Serial Communications Settings:
  - Serial port: COM1
  - Parity: Even
  - Data bits: 8
  - Stop bits: 1
  - Data rate: 9600
- Phone number: (empty)
- PollRate = 0:01
- Poll = (empty)
- Communication alarm priority: 8
- Retry attempts: 4
- Receive timeout: 500 msec
- Skip every 5 poll requests after comm failure

**Route** refers to a unique path through any network device that leads to the PLC port. When using the SY/MAX card, the first address must be a zero followed by the address of the card. This is because the SY/MAX card edge is considered to be port zero. The RS422 port on the SY/MAX card is considered to be port one. Separate each address in the route with a period, comma, or space.

**Model** specifies the particular type of PLC represented by this object. The Model you select determines what native data members comprise the object.

**Interface** is how the driver communicates with the PLC. The choices are Serial, SY/LINK, and SY/ENET.

**PollRate** is a numeric expression that determines how often to poll the device. Lookout polls the device at the specified time interval. Normally, this is a simple time constant such as 0:01 (one second). See *Numeric Data*

*Members* in Chapter 2, *How Lookout Works*, of the *Getting Started with Lookout* manual for information on entering time constants.

**Poll** is a logical expression. When this expression changes from FALSE to TRUE, Lookout polls the device. Use a simple expression like the signal from a pushbutton, or a complex algorithm.

**Communication alarm priority** determines the priority level of the alarms generated by the SquareD object.

**Retry attempts** specifies the consecutive number of times Lookout attempts to establish communication with a device if there is no valid response. After the specified number of **Retry attempts**, the object generates an alarm and begins to skip poll requests as specified by the **Skip every n poll requests after comm failure** parameter. Once Lookout reestablishes communication, it polls the device on the cycle defined by **PollRate**.

**Receive timeout** is the time Lookout waits for a response from a device before retrying the poll request.

## Serial Port Interface Parameters

The **Serial Interface** selection enables serial port communication from a computer to the programming port on a PLC. The previous diagram shows a SquareD PLC configured for serial communications.

**Serial port** specifies which RS-232C port on your computer the object uses for communication to the physical device.

**Data rate, Parity, Data Bits, and Stop bits** reference the settings of the hardware device. Choose the settings as configured on your PLC.

**Phone number** specifies the number dialed if the serial port setting is configured for dial-up. This number only applies to the individual object.

**Data rate** is the speed at which the driver communicates with the PLC via the serial port.

**Select Options»Serial Ports** for more information.



## SY/LINK Interface Parameters

The SY/LINK **Interface** selection enables direct connection of a computer to a SquareD network using a SY/MAX card. The following diagram shows a SquareD object configured for SY/MAX communications.

The screenshot shows the 'Create Square D' dialog box with the following settings:

- Name: SquareD1
- Model: SCP-4xx
- Route: (empty)
- Interface: SY/LINK
- SY/LINK Card Settings:
  - Network Address: 12
  - Interrupt: 7
  - Card Memory Address: Board not found
  - RS422 Baud Rate: 9600
  - Parity: EVEN
  - Network:
    - Baud Rate: 500k
    - Word Size: 8
    - Net Size: 31
    - Mode: SY/MAX
- PollRate = 0.01
- Poll = (empty)
- Communication alarm priority: 8
- Retry attempts: 4
- Receive timeout: 500 msec
- Skip every 5 poll requests after comm failure

**Network address** identifies the address of a computer interface card in the SY/MAX network. Valid addresses range from 0 to 99. The card node address must be unique. It must not have the same address as any other device on the network.

**Interrupt** identifies the interrupt (IRQ) setting of your SY/MAX interface card in a PC. Assigning an interrupt to the interface card improves overall computer performance. Any time the card receives a response, it generates an interrupt recognized by Lookout.

**Card memory address** specifies the base address location of the card memory. This is selected automatically. For now, only one SY/MAX card in a computer is supported. Lookout looks for the card and fills this box with the address. If the card is not found, it is indicated here.

**Network** settings include net size and baud rate. **Net size** identifies the number of devices on the network. The SY/MAX card and all of the PLCs or NIMs must have the same settings for successful communications. A net size of 31 should promote a faster response time. **Baud rate** selects the

baud rate at which the SY/LINK card tries to communicate on the SY/NET network.

The **RS-422** settings include **baud rate**, **parity**, and **word size**. These parameters reference the settings of the hardware device. Choose the settings as configured on you PLC.

**RS-422 mode** chooses either SY/MAX or Net-to-net. Choosing SY/MAX allows normal network operations. Choosing Net-to-net allows extended distributed networks, large capacity networks (more than 200 devices), or network redundancy (more than one path between two devices). The default is SY/MAX.

## SY/ENET Interface Parameters

The SY/ENET **Interface** selection enables direct connection of a computer to an Ethernet network using an Ethernet card. SY/ENET is only available on computers running Windows NT. You cannot use SquareD ENET under Windows 9x.

To use SquareD with the ENET protocol, install the Lookout Ethernet driver as a protocol in the Windows Network Control Panel. Lookout installs the files LKETHER.SYS and OEMSETUP.INF when you install Lookout. To install the Lookout Ethernet Driver, select **Settings»Control Panel»Network** and click on the **Protocols** tab. Click **Add**, then click **Have Disk**, changing the default path from A:\ to your main Lookout directory. Follow the on-screen instructions to complete installation of the driver.

The following diagram shows a SquareD object configured for SY/ENET communications.

## Using SY/ENET with More Than One Ethernet Board in Your System

If you have more than one Ethernet board installed in your computer, configure your system properly to use the SquareD driver object.

Open the **Network** dialog Box from **Settings»Control Panel»Network** and select the **Bindings** tab. Under the **Lookout Ethernet Driver Heading**, highlight all ethernet boards *except* the one connected to your SquareD network, and click the **Disable** button. For example, in the following figure, the Intel Ether Express 16 LAN adapter is connected to the SquareD network.

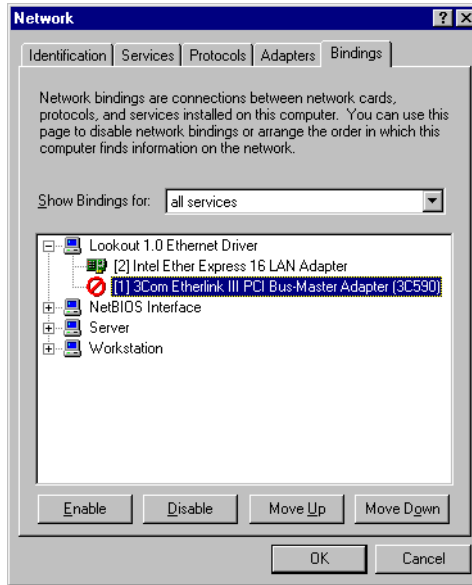

Select the **Services** tab. Then select **NetBios Interface** and click **Properties**. The **NetBIOS Configuration** dialog box appears. Make sure that the Squared Ethernet card is **LANA Number 000** and the **Network Route** is `Nbf`.

## Squared Data Members

Each Squared object contains a great deal of data. All readable and writable members (inputs/outputs) are bundled with the object. As soon as you create an object you immediately have access to all the object data members.

The Squared object class automatically generates an efficient read/write blocking scheme based on the inputs and outputs used in the process file. It is not required to build a I/O blocking table. However, ensure peak performance by organizing the PLCs data into contiguous groups.

The default addressing for bits in the Squared object starts at 0 (see the data member below, 1.0 – 8192.15). Some Squared users may be more comfortable with bit addressing that starts at 1. Those users may change the bit addressing of the Squared driver to start at 1. The data member 1.0 – 8192.15 is then displayed and addressed as 1.1 – 8192.16.

Create a file named `SQUARED.INI` in the Lookout folder. Enter the following two entries.

[All]

Bit1Addressing=1

As with all such .INI files, if the Lookout process is run on another computer, the .INI file must be copied into the Lookout folder on the local computer for the process to run correctly.

**Table 3-89.** SquareD Data Members

Data Member	Type	Read	Write	Description
1 – 8192	numeric	yes	yes	16-bit unsigned integer ranging from 0 to 65535.
1. – 8192.	logical	yes	yes	Logical I/O that reads and writes the entire register. When you write to the register, all bits in the word go TRUE or FALSE.
1.0 – 8192.15	logical	yes	yes	Individual bits in a register read as logical ON/OFF values. The least significant bit is 0 and the most significant bit is 15.
ST1.16 – ST8192.31	logical	yes	no	Individual status bits in a register read as logical ON/OFF values. The least significant bit is 16 and the most significant bit is 31.
CommFail	logical	yes	no	Object-generated signal that is on if, for whatever reason, Lookout cannot communicate with the device.
F1 – F8191 (odd only)	numeric	yes	yes	32-bit IEEE floating point register that reads two adjacent holding registers as a single 32-bit floating point value
OffHook	logical	no	yes	When TRUE, this flag instructs the object to retain exclusive use of its assigned communication port.
Poll	logical	no	yes	When this value transitions from FALSE to TRUE, Lookout polls the device.
PollRate	numeric	no	yes	Lookout expression that determines the device polling frequency.

**Table 3-89.** SquareD Data Members (Continued)

<b>Data Member</b>	<b>Type</b>	<b>Read</b>	<b>Write</b>	<b>Description</b>
S1 – S8192	numeric	yes	yes	16-bit signed word ranging from –32,768 to +32,768.
Update	logical	yes	no	Object-generated signal that pulses low (FALSE) each time it polls the device.

## SquareD Error Messages

The SquareD object class reports the status of commands it issues to the PLC. When SquareD receives an error response from a PLC, it reports the failure as an alarm containing the status code and its meaning. The following are examples of alarms:

**SY/MAX initialization error:(0)Cannot initialize SY/LINK board**

**SY/MAX polling error:(3)Illegal address attempted**

**Response error:(3) Received NAK in response**

# Tesco

Tesco is a protocol driver object class Lookout uses to communicate with Liquitronic LIQ programmable controllers using the **LIQ4** (Data Express) and **LIQ5** (Data Express Plus) messaging protocols. Create one Tesco object for each controller.

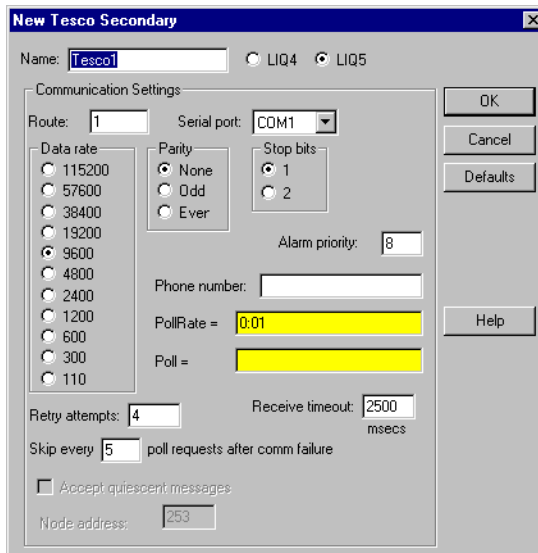

**Figure 3-39.** Tesco Configuration Parameters Dialog Box

**Route** refers to the PLC address setting as specified in its Configuration Table. When using **LIQ4**, it is a simple node address (1 to 255). When using **LIQ5**, Route contains both the network address and the node address in the format `network.node`, as shown in the diagram.

**Serial port** specifies which port the object uses for communication to the external device. This does not specify the communication topology (such as, radio, dial-up, hard wired). Communication type is determined by the **Options»Serial Ports...** command.

**Data rate**, **Parity**, and **Stop bits** reference the settings on the hardware device.

The **Defaults** button replaces the current settings with default values.

**Alarm priority** determines the priority level of Tesco communication alarms.

**Phone number** specifies the number to be dialed if the serial port setting is configured for dial-up. This number only applies to the individual driver object.

**PollRate** is a numeric expression that determines how often to poll the device. The Tesco object then polls the device at the specified time interval. Normally, this is a simple time constant such as 0:01 (one second). See *Numeric Data Members* in Chapter 2, *How Lookout Works*, of the *Getting Started with Lookout* manual for more information on entering time constants.

**Poll** is a logical expression. When this expression changes from FALSE to TRUE, Lookout polls the device. You can use a simple expression like the signal from a pushbutton, or a complex algorithm.

**Retry attempts** specifies the consecutive number of times Lookout attempts to establish communications with a device it does not get a valid response from. After **Retry attempts** times, the object generates a communication alarm and Lookout moves on to the next device in the polling queue (if any).

**Receive timeout** is the time delay Lookout uses in waiting for a response from a device before retrying the request.

The **Skip every N poll requests after comm failure** setting instructs Lookout not to poll a device it has lost communication with on every scheduled poll. Instead, Lookout skips the device in the polling cycle accordingly. Once communications are reestablished, the device is polled on its regular cycle.

Selecting the **Accept quiescent messages** checkbox enables Lookout to accept unsolicited, unpollled messages from the PLC. This parameter applies to LIQ IV only.

**Node Address** denotes the address of the computer you are running Lookout on in the TESCO device route. The default value is 253. This parameter applies to LIQ IV only.

## Tesco Data Members

Like other protocol driver objects, Tesco objects can contain a great deal of data. All readable and writable members (inputs/outputs), polling instructions, and so on, are bundled with the object. As soon as you create a Tesco object you immediately have access to all the object data members (see the data member list in Table 3-90).

**Table 3-90.** Tesco Data Members

Data Members	Type	Read	Write	Description
AO0 – AO1023	numeric	yes	yes	Analog Output register capable of holding a 32-bit IEEE floating point value for use in internal Tescode programming, or a physical AO signal value as a 12-bit whole number ranging from 0 to 4095.
CommFail	logical	yes	no	Driver-generated signal that is ON if Lookout cannot communicate with the device for whatever reason.
IR0 – IR1023	numeric	yes	yes	Index register containing a 32-bit unsigned integer ranging from 0 to 4,294,967,295.
L0 – L1023	numeric	yes	yes	Level (Analog Input) register capable of holding a 32-bit IEEE floating point value for use in internal Tescode programming, or a physical AI signal as a 12-bit whole number ranging from 0 to 4095.
P0 – P1023	logical	yes	yes	Pump (Discrete Output) register associated with a physical output channel.
Poll	logical	no	yes	When this value transitions from FALSE to TRUE, Lookout polls the device.
PollRate	numeric	no	yes	Specifies the frequency at which the device is to be polled.



**Table 3-90.** Tesco Data Members (Continued)

<b>Data Members</b>	<b>Type</b>	<b>Read</b>	<b>Write</b>	<b>Description</b>
S0 – S1023	logical	yes	yes	Status (Digital Input) register that can represent either a physical input channel or an internal Tescode programming flag.
SP0 – SP1023	numeric	yes	yes	Setpoint register that holds a 32-bit IEEE floating point value with a range of $\pm 3.37 \times 10^3$
T0 – T1023	numeric	yes	yes	Timer/Counter register containing Pulse counters, Hours timers, HMS timers, Event counters, and Seconds timers as documented in the TESCO LIQ 5 Programmable Control Operations Manual
Update	logical	yes	no	Driver-generated signal that pulses each time the driver polls the device

# Tiway

Tiway is a protocol driver object Lookout uses to communicate with series 5xx PLCs manufactured by Siemens, formerly made by Texas Instruments.

Protocol driver objects contain a great deal of data. All readable and writable members (inputs/outputs), polling instructions, read/write blocking, serial port usage, and so on are bundled with the object. As soon as you create a Tiway object you immediately have access to all the object data members (see data member list in this section).



**Note** Lookout protocol driver objects automatically generate an efficient read/write blocking scheme based on the inputs and outputs being used in your process file. You are not required to build your own I/O blocking table.

**Figure 3-40.** Tiway Configuration Parameters Dialog Box

**PLC Model** specifies the PLC model number for the requested device.

**PollRate** is a numeric expression that determines how often to poll the device. Tiway then polls the device at the specified time interval. Normally, this is a simple time constant such as 0:01 (one second). See *Numeric Data Members* in Chapter 2, *How Lookout Works*, of the *Getting Started with Lookout* manual for more information on entering time constants.

**Poll** is a logical expression. When this expression changes from FALSE to TRUE, Lookout polls the device. You can use a simple expression like the signal from a pushbutton, or a complex algorithm.

**Receive timeout** is the time delay Lookout uses in waiting for a response from a device before retrying the request.

**Retry attempts** specifies the consecutive number of times Lookout attempts to establish communications with a device it does not get a valid response from. After Retry attempts times, Tiway generates a communication alarm and Lookout moves on to the next device in the polling queue (if any).

**Alarm priority** determines the priority level of Tiway generated alarms.

**Phone number** specifies the number to be dialed if the serial port setting is configured for dial-up. This number only applies to the individual protocol object.

The **Skip every \_\_\_ polls** setting instructs Lookout not to poll a device it has lost communication with on every scheduled poll. Instead, Lookout skips the device in the polling cycle accordingly. Once communications have been reestablished, the device is polled on its regular cycle.

## Update Write Settings

The Lookout default for the Tiway driver object is for the object to perform an update write to the PLC registers every 100 polls. Notice that this can be problematic if the PLC has been changing its own register values. To change this default operation, you must create an entry in the `Lookout.INI` file. Create a Tiway group with the key `UpdateOutputs`.

Setting the `UpdateOutputs` key equal to 0 means the Tiway object will not perform update writes. Setting the key equal to some positive integer N will set the Tiway object to perform update writes once every N polls.

See Appendix C, *.INI File Settings for Lookout*, in the *Lookout Developer's Manual* for more information on using the `Lookout.INI` file. You can also refer to the `Lookout.INI` file topic in Lookout Help for additional information.

## Communication Techniques

Lookout communicates with Siemens PLCs in several ways: direct serial connection to the **Local port**, serial connection to an **external Unilink Host Adapter**, through an internal **Unilink PC Adapter** card, or through an internal **CTI TCP/IP** card.

### Local Port

The **Local port** settings determine the **serial port**, **data rate**, and **phone number** (if any) to be used in a direct connect setup. Because the **Local port** protocol does not include address information, this option is limited to only one (1) PLC per serial port.

### Unilink Host Adapter

If **Unilink Host Adapter** is selected, you must specify the **Serial port** to be used and the **NIM (Network Interface Module) address** as set at the PLC. You also should configure several settings on the Unilink Host Adapter by selecting the **Configure UHA...** button.

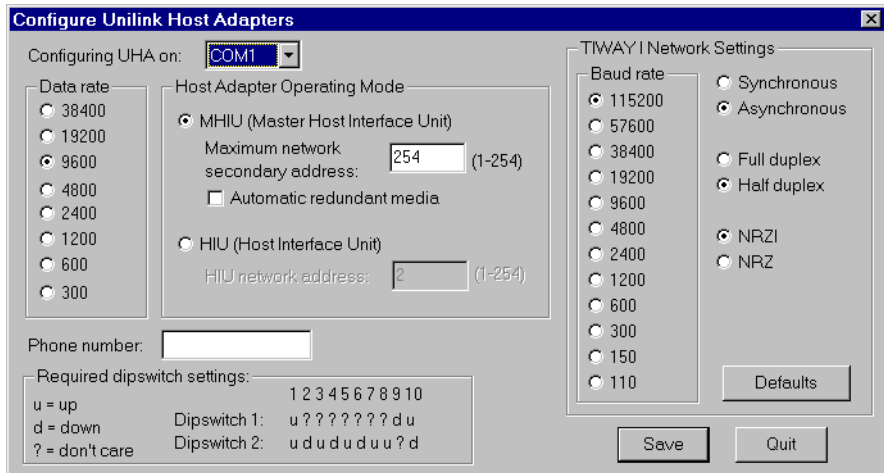

The settings in this dialog box are globally applied to all PLCs on the specified TIWAY network (each network requires a separate serial port). Therefore, it is only necessary to configure each Unilink Host Adapter one time—you need not repeat this step every time you create a new Tiway object.

**Data rate** specifies the communication speed between the computer and the Unilink Host Adapter. It also determines the required dip switch settings on the UHA for the selected baud rate.

The **Host Adapter Operating Mode** determines if the Unilink Host Adapter is the network manager (**Master Host Interface Unit**) or just another network secondary (**Host Interface Unit**). There must be exactly one MHIU per TIWAY network.

Enabling **Automatic redundant media** instructs the Unilink Host Adapter to attempt communications over a redundant TIWAY network to any secondary it loses communications with.

The **TIWAY I Network Settings** configure the communication parameters for the TIWAY network. This network runs between the Unilink Host Adapter and its secondaries. The Lookout default network settings correspond to the default NIM settings as shipped from Siemens. See your TIWAY documentation to modify any of these parameters.

## Unilink PC Adapter

Because the **Unilink PC Adapter** is an internal card, it eliminates the 19200 baud serial bottleneck and replaces it with the 8 MHz PC ISA bus speed. Therefore, the performance gains over the **Unilink Host Adapter** and **Local port** settings can be substantial.

If **Unilink PC Adapter** is selected, you must specify the **Card** to be used and the **NIM** (Network Interface Module) **address** as set at the PLC. You should also configure several settings on the Unilink PC Adapter by selecting the **Configure PCA...** button.

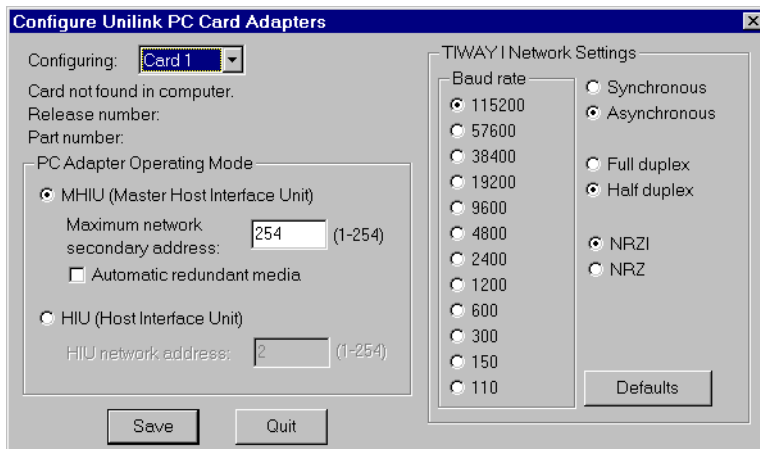

The settings in this dialog box are globally applied to all PLCs on the specified TIWAY network (each network requires a separate card). Therefore, it is only necessary to configure each Unilink PC Adapter one time—this step need not be repeated every time a new Tiway object is created.

The **PC Adapter Operating Mode** determines if the Unilink PC Adapter is the network manager (**Master Host Interface Unit**) or just another network secondary (**Host Interface Unit**). There must be exactly one MHIU per TIWAY network.

Enabling **Automatic redundant media** has no effect with the PC Adapter card because it has only one port. If Siemens adds a second port, Lookout automatically supports this option.

The **TIWAY I Network Settings** configure the communication parameters for the TIWAY network. This network runs between the Unilink PC Adapter card and its secondaries. Lookout default network settings correspond to the default NIM settings as shipped from Siemens. See your TIWAY documentation to modify any of these parameters.

## CTI TCP/IP

Lookout supports the Control Technology Incorporated (CTI) Ethernet TCP/IP adapter cards that can be installed in SIMATIC TI545 PLCs. In order to work with such cards, your PC must be equipped with an Ethernet network card and a Windows Sockets-Compliant TCP/IP software package. Such packages are available from Microsoft, FTP Software, and NetManage, Inc.

The Lookout **CTI TCP/IP** protocol option is Windows Sockets Compliant. It uses connectionless UDP sockets in software, an industry standard for TCP/IP protocols. In this protocol, a FIFO (first-in, first-out) stack is used to temporarily store communication messages if the data highway is busy or if multiple poll request are generated by several Tiway objects.

Because **CTI TCP/IP** utilizes sockets to momentarily store poll requests, this protocol eliminates bottlenecks imposed by multiple Tiway objects trying to access the data highway at the same time. Performance gains over **Local port, Unilink Host Adapter** and **Unilink PC Adapter** settings can be substantial when you are configuring a system that has several PLCs on the same network.

If **CTI TCP/IP** is selected, you need to specify the **IP address** (Internet protocol address) of the PLC. An Internet protocol address consists of four numbers, separated by periods. Each number ranges from zero to 255 decimal. Thus, a typical Internet address might be 128.7.9.231. Ensure that the **IP address** you enter matches the Internet protocol address of the PLC as specified in its EEPROM or as programmed using PCL.

You can add a secondary IP address to the **CTI TCP/IP** parameter. Lookout now toggles between the primary and secondary IP address after a COM failure (assuming a secondary address exists). Enter the secondary ID after the first, preceded by a space or a comma. For example:

```
207.68.156.61, 1.2.3.4
```

## Tiway Data Members

**Table 3-91.** Tiway Data Members

Data Members	Type	Read	Write	Description
AERR1 – AERR32000	numeric	yes	yes	(Analog Alarm) Error
AHA1 – AHA32000	numeric	yes	yes	(Analog Alarm) High alarm limit
AHHA1 – AHHA32000	numeric	yes	yes	(Analog Alarm) High high alarm limit
ALA1 – ALA32000	numeric	yes	yes	(Analog Alarm) Low alarm limit
ALLA1 – ALLA32000	numeric	yes	yes	(Analog Alarm) Low low alarm limit
AODA1 – AODA32000	numeric	yes	yes	(Analog Alarm) Orange deviation limit

**Table 3-91.** Tiway Data Members (Continued)

<b>Data Members</b>	<b>Type</b>	<b>Read</b>	<b>Write</b>	<b>Description</b>
APVH1 – APVH32000	numeric	yes	yes	(Analog Alarm) Process variable high limit
APVL1 – APVL32000	numeric	yes	yes	(Analog Alarm) Process variable low limit
ARCA1 – ARCA32000	numeric	yes	yes	(Analog Alarm) Rate of change limit
ASP1 – ASP32000	numeric	yes	yes	(Analog Alarm) Setpoint
ASPH1 – ASPH128	numeric	yes	yes	(Analog Alarm) Setpoint high limit
ASPL1 – ASPL128	numeric	yes	yes	(Analog Alarm) Setpoint low limit
ATS1 – ATS32000	numeric	yes	yes	(Analog Alarm) Sample rate
AVF1 – AVF128	numeric	yes	yes	(Analog Alarm) Alarm flags
C1 – C32000	logical	yes	yes	Control Registers
CommFail	logical	yes	no	Driver-generated signal that is ON if Lookout cannot communicate with the device for whatever reason
K1 – K32000	numeric	yes	yes	K-memory unsigned 16-bit integer value ranging from 0 to 65535
K1. – K32000.	numeric	yes	yes	K-memory 32-bit IEEE floating point value
K1D – K32000D	numeric	yes	yes	K-memory 32-bit unsigned integer value
K1S – K32000S	numeric	yes	yes	K-memory signed 16-bit integer value ranging from -32768 to 32767
LADB1 – LADB64	numeric	yes	yes	(Analog Alarm) Deadband
LADB1 – LADB64	numeric	yes	yes	(Loop) Deadband
LER1 – LER64	numeric	yes	no	(Loop) Error
LHA1 – LHA64	numeric	yes	yes	(Loop) High alarm limit
LHHA1 – LHHA64	numeric	yes	yes	(Loop) High high alarm limit
LKC1 – LKC64	numeric	yes	yes	(Loop) Gain
LKD1 – LKD64	numeric	yes	yes	(Loop) Derivative gain



**Table 3-91.** Tiway Data Members (Continued)

<b>Data Members</b>	<b>Type</b>	<b>Read</b>	<b>Write</b>	<b>Description</b>
LLA1 – LLA64	numeric	yes	yes	(Loop) Low alarm limit
LLLA1 – LLLA64	numeric	yes	yes	(Loop) Low low alarm limit
LMN1 – LMN64	numeric	yes	yes	(Loop) Output
LMX1 – LMX64	numeric	yes	yes	(Loop) Bias
LODA1 – LODA64	numeric	yes	yes	(Loop) Orange deviation limit
LPV1 – LPV64	numeric	yes	yes	(Loop) Process variable
LPVH1 – LPVH64	numeric	yes	yes	(Loop) Process variable high limit
LPVL1 – LPVL64	numeric	yes	yes	(Loop) Process variable low limit
LRCA1 – LRCA64	numeric	yes	yes	(Loop) Rate of change limit
LSP1 – LSP64	numeric	yes	yes	(Loop) Setpoint
LSPH1 – LSPH64	numeric	yes	yes	(Loop) Setpoint high limit
LSPL1 – LSPL64	numeric	yes	yes	(Loop) Setpoint low limit
LTD1 – LTD64	numeric	yes	yes	(Loop) Rate
LTI1 – LTI64	numeric	yes	yes	(Loop) Reset
LTS1 – LTS64	numeric	yes	yes	(Loop) Sample rate
LYDA1 – LYDA64	numeric	yes	yes	(Analog Alarm) Yellow deviation limit
LYDA1 – LYDA64	numeric	yes	yes	(Loop) Yellow deviation limit
Poll	logical	no	yes	When this value transitions from FALSE to TRUE, Lookout polls the device
PollRate	numeric	no	yes	Specifies the frequency at which the Lookout object polls the device
STW1 – STW32000	numeric	yes	no	Status Words
TCC1 – TCC32000	numeric	yes	yes	(Analog Alarm) Timer/counter current
TCP1 – TCP32000	numeric	yes	yes	(Analog Alarm) Timer/counter preset

**Table 3-91.** Tiway Data Members (Continued)

<b>Data Members</b>	<b>Type</b>	<b>Read</b>	<b>Write</b>	<b>Description</b>
Update	logical	yes	no	Driver-generated signal that pulses each time the driver polls the device
V1 – V32000	numeric	yes	yes	V-memory unsigned 16-bit integer value ranging from 0 to 65535
V1. – V32000.	numeric	yes	yes	V-memory 32-bit IEEE floating point value
V1B1 – V32000B16	logical	yes	yes	One bit of a word written out as a whole word
V1D – V32000D	numeric	yes	yes	V-memory 32-bit unsigned integer value
V1S – V32000S	numeric	yes	yes	V-memory signed 16-bit integer value ranging from –32768 to 32767
V1T – V32000T	text	yes	yes	Two characters of text
WX1 – WX32000	numeric	yes	no	Word Image Inputs—16-bit values that typically range from 6400 – 32000 for 4 – 20 mA signals, and 0 – 32000 for 0 – 5V signals.
WY1 – WY32000	numeric	yes	yes	Word Image Outputs—16-bit values that typically range from 6400 – 32000 for 4 – 20 mA signals, and 0 – 32000 for 0 – 5V signals.
X1 – X32000	logical	yes	no	Discrete Inputs—unassigned Xs may be used as control registers
Y1 – Y32000	logical	yes	yes	Discrete Outputs—same memory space as Discrete Inputs, so X37 references the same point as Y37. Unassigned Ys may be used as control registers

## Importing APT Name Files

After you have created at least one Tiway object, the Tiway class adds a menu selection to the Lookout **Options** menu you can use to import an APT name file database for each Tiway object created. You can re-import name files as your APT programs are modified, and Lookout readjusts the aliased name names automatically, in real time.

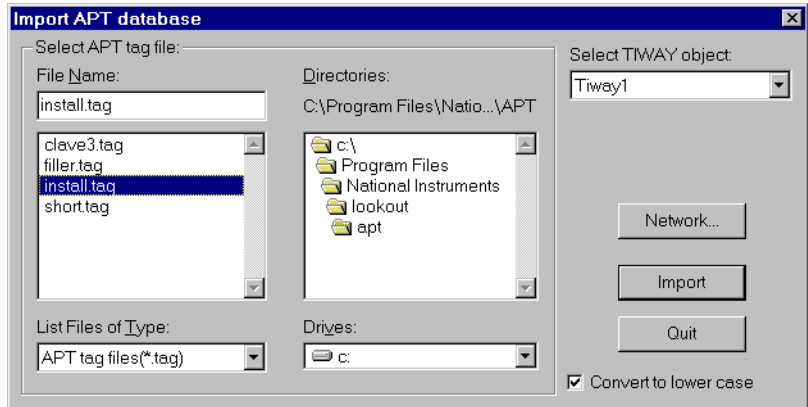

## Toshiba Mseries/Toshiba Tseries

Toshiba is a protocol driver class Lookout uses to communicate with Toshiba M Series Ex100, M20, M49 and T Series T1, T2, and T3 devices using the Host Link serial communication protocol.

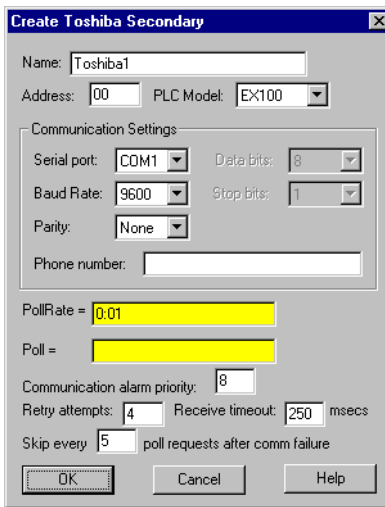

Figure 3-41. Toshiba M Series Configuration Parameters Dialog Box

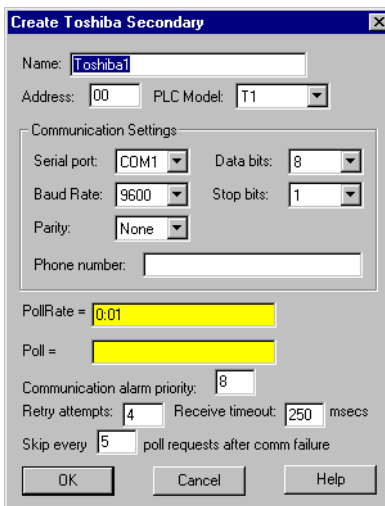

Figure 3-42. Toshiba T Series Configuration Parameters Dialog Box

**Address** specifies the address of the PLC. The maximum address for a T Series PLC is 32 and for an M Series PLC, 15.

**Serial port** specifies which COM port the object uses for communicating to the external device. This does not specify the communication type. Communication type is determined by the **Options»Serial Ports...** command.

**Data rate** indicates the baud rate that Lookout uses to communicate with the hardware device. The **Data rate** setting should match the selection made on the physical device.

**Data bits** indicates the number of data bits that Lookout uses to communicate with the hardware device. The **Data bits** setting should match the selection made on the physical device.

**Stop bits** indicates the number of stop bits that Lookout uses to communicate with the hardware device. This setting should match the selection made on the physical device.

**Parity** indicates the parity that Lookout uses to communicate with the hardware device. This **Parity** setting should match the selection made on the physical device.

**Phone number** specifies the number to be dialed if the selected serial port is configured for dial-up. This **Phone number** only applies to the individual protocol object.

**PollRate** is a numeric expression that determines how often to poll the device. The object then polls the device at the specified time interval. Normally, this is a simple time constant such as 0:01 (one second). See *Numeric Data Members* in Chapter 2, *How Lookout Works*, of the *Getting Started with Lookout* manual for more information on entering time constants.

**Poll** is a logical expression. When this expression changes from FALSE to TRUE, Lookout polls the device. You can use a simple expression like the signal from a pushbutton, or a complex algorithm.

**Communication alarm priority** determines the priority level of alarms generated by the Toshiba object. Such alarms are typically related to communications with the physical device.

**Retry attempts** specifies the consecutive number of times Lookout attempts to establish communications with a device when it is not getting a valid response. After it tries the number of **Retry attempts** specified, the Toshiba object generates an alarm and releases the communication port back to the communications subsystem. The subsystem then moves on to the next device in the polling queue (if any). See Chapter 3, *Serial Port Communication Service*, in the *Lookout Developer's Manual* for more information.

**Receive timeout** is the time delay Lookout uses in waiting for a response from a device before retrying the request.

The **Skip every...** setting instructs Lookout not to poll a device it has lost communication with on every scheduled poll. Instead, Lookout skips the device in the polling cycle. Once communications have been reestablished, the device is polled on its regular cycle.

## Toshiba Data Members

A Toshiba object contains a great deal of data. You can read and write to all predefined data points. When you create a Toshiba object, you have immediate access to all the data members for that object.

As with all Lookout drivers, you can access I/O points and other data through data members. The following is a table of data members currently available in the Toshiba object class.

**Table 3-92.** Toshiba M Series Data Members

Data Member	Type	Read	Write	Description
C:0 – C:1536	numeric	yes	no	Counter.
CommFail	logical	yes	no	Object-generated signal that is ON if, for any reason, Lookout cannot communicate with the device(s).
D:0, D:1536	numeric	yes	yes	Data register.
Poll	logical	no	yes	When this value transitions from FALSE to TRUE Lookout polls the device.
PollRate	numeric	no	yes	Lookout expression that determines the device polling frequency.
R:0, R:1024	logical	yes	yes	Auxiliary relay device.

**Table 3-92.** Toshiba M Series Data Members (Continued)

<b>Data Member</b>	<b>Type</b>	<b>Read</b>	<b>Write</b>	<b>Description</b>
RW:0, RW:64	numeric	yes	yes	Auxiliary relay register.
T:0, T:128	numeric	yes	yes	Timer register.
Update	logical	yes	no	Object-generated signal that pulses low each time it polls the device.
Y:0, Y:512	logical	yes	yes	External output device.
YW:0, YW:64	numeric	yes	yes	External output register.
Z:0, Z:512	logical	yes	yes	Link device.
ZW:0, ZW:64	numeric	yes	yes	Link register.

**Table 3-93.** Toshiba T Series Data Members

<b>Data Member</b>	<b>Type</b>	<b>Read</b>	<b>Write</b>	<b>Description</b>
CommFail	logical	yes	no	Object-generated signal that is ON if, for any reason, Lookout cannot communicate with the device(s).
D:0, D:1536	numeric	yes	yes	Data register.
Poll	logical	no	yes	When this value transitions from FALSE to TRUE Lookout polls the device.
PollRate	numeric	no	yes	Lookout expression that determines the device polling frequency.
R:0, R:1024	logical	yes	yes	Auxiliary relay device.
RW:0, RW:64	numeric	yes	yes	Auxiliary relay register.
S:0 – S:1024	logical	yes	yes	Binary timer register.
SW:0 – SW:62	numeric	yes	yes	Data register.
T:0, T:128	numeric	yes	no	Timer register.
Update	logical	yes	no	Object-generated signal that pulses low each time it polls the device.
X:0, X:512	logical	yes	no	External input device.

**Table 3-93.** Toshiba T Series Data Members (Continued)

<b>Data Member</b>	<b>Type</b>	<b>Read</b>	<b>Write</b>	<b>Description</b>
XW:0, XW:64	numeric	yes	no	External input register.
Y:0, Y:512	logical	yes	yes	External output device.
YW:0, YW:64	numeric	yes	yes	External output register.

## Toshiba Status Messages

### **No response within timeout period**

Lookout received no response from a device within the **Receive timeout** period. The Toshiba object is able to use the COM port, but when it polls the device, it does not respond—as if it is not even there.

### **Toshiba errors reported in the response**

These errors are reported by the Toshiba device and are in turn reported to the user in text form.

**Missing address marker in frame.**

**Invalid address in response.**

**Invalid command in response.**

**Missing BCC marker in frame.**

**Invalid BCC.**

**Missing end of frame marker.**

All these alarms indicate a garbled response frame. Check the receive gap or the retry setting in Lookout.



# Wisdom

Wisdom is an object class that Lookout uses to communicate with the Wisdom Coprocessor Card. Create one Wisdom object for each Wisdom card installed in the computer.

The Wisdom object scans configured data members for changes 10 times per second.

Wisdom cards are single-board computers. They communicate with the PC through dual-ported memory (that is, RAM accessed by both the PC processor and the Wisdom card processor).

In this example, as shown in the following figure, jumper settings on the card are configured to use hardware interrupt 7 and beginning memory address D000.

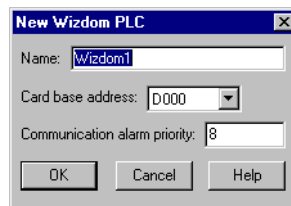

**Card base address** specifies the beginning memory location of the dual ported RAM address. It should match jumper settings on the card. The card uses 8K of physical memory.

When the Wisdom card writes an input value into a memory location, the card generates an interrupt (if so configured), causing the Lookout Wisdom object to immediately scan. This ensures faster responses to field changes.



**Note** Be sure to verify that no other drivers are mapped to the selected memory location and interrupt.



**Note** Because the EMM386 memory manager only recognizes the first 4K of mapped memory, it is important to add a memory exclude statement to your computer CONFIG.SYS file as instructed in the card documentation.

## Wisdom Data Members

Like other object classes designed to communicate with external I/O, Wisdom objects can contain a great deal of data. All readable and writable members (inputs/outputs), polling instructions, and so on are bundled with the object. As soon as you create a Wisdom object you immediately have access to all the object data members.

**Table 3-94.** Wisdom Data Members

Data Members	Type	Read	Write	Description
B0 – B1903	numeric	yes	yes	8-Bit word ranging from 0 to 255
B0.0 – B1903.7	logical	yes	yes	1 Bit in an 8-Bit word
BCD0.2 – BCD1900.16	numeric	yes	yes	Reserved for future binary coded decimal implementation
BS0 – BS1903	numeric	yes	yes	Signed 8-bit word ranging from –128 to 127
BS0.0 – BS1903.7	logical	yes	yes	1 Bit in a signed 8-bit word
DF0 – DF1896	numeric	yes	yes	64-bit IEEE floating point double precision word
DS0 – DS1900	numeric	yes	yes	Signed 32-bit double-precision word ranging from –2,147,483,648 to 2,147,483,648
DS0.0 – DS1900.31	logical	yes	yes	1 Bit in a signed 32-bit word
DW0 – DW1900	numeric	yes	yes	32-Bit double-precision word ranging from 0 to 4,294,967,295
DW0.0 – DW1900.31	logical	yes	yes	1 Bit in a 32-bit word
F0 – F1900	numeric	yes	yes	32-bit IEEE floating point word
S0 – S1902	numeric	yes	yes	Signed 16-bit word ranging from –32,768 to 32,767
S0.0 – S2047.15	logical	yes	yes	1 Bit in a signed 16-bit word
STR0 – STR1900	text	yes	yes	Reserved for future character string implementation
W0 – W1902	numeric	yes	yes	16-Bit word ranging from 0 to 65,535
W0.0 – W1902.15	logical	yes	yes	1 Bit in a 16-Bit word

**Comments** The data member addresses listed in the data member table all share the same 4K of memory. For this reason, the following are all the same bit:

$$\text{B391.5} = \text{W391.5} = \text{DS391.5}$$

---

# Object Class Parameters

You sometimes need to set Lookout parameters in a context other than a create object dialog box, such as when you configure an Aggregate definition process or when you work with a Lookout .LKS file.

Unfortunately, Lookout parameters are not identified by name outside the context of a create object dialog box. You identify them by their position in a .LKS file statement, and by their number when configuring an Aggregate definition.

This document contains tables for most of the Lookout objects containing the parameters for most of the Lookout objects, identified both by number and name. This file is provided for use with the Lookout 4.5 beta release. Complete documentation of Lookout parameters will be integrated with the rest of the Lookout object documentation for the final release version of Lookout 4.5.

## A Note on Data Types

---

Data types are listed in the table as follows:

Log = logical	accepts yes/no; on/off as input, Lookout object name, expressions that evaluate to logical value.
Num = numeric	accepts numeric input without double quotes (including Lookout object names)
Txt = text	requires double quotes at beginning or end of string
Cnst = constant	
Var = variable	

Parameters must match their data type. Constants are fixed and entered as the appropriate data type.

You cannot enter variables for parameters exposed in an Aggregate object. You can enter variables for parameters when you are working in a .LKS file.

Variables are Lookout expressions that can be simple constants or can include condition testing, control names, and simple expression manipulations. The rules for entering expressions in Lookout apply to entering values for these parameters.

When a parameter data type indicates a parameter accepts a variable, notice that it can also therefore accept a constant. Parameters that you can leave empty will add /NULL to the Data Type column.

## Lookout Driver/Protocol Objects

### AB\_PLC2/PLC5/SLC500/Logix

Parameter	Name	Type	Description
1	PLC Model	TxtCnst	PLC model: "MicroLogix 1500" "PLC 2/30", "PLC5/10", "PLC5/11", "PLC5/12", "PLC5/15", "PLC5/20", "PLC5/25", "PLC5/25", "PLC5/30", "PLC5/40", "PLC5/40L", "PLC5/V40", "PLC5/V40L", "PLC5/60", "PLC5/60L", "PLC5/VME", "PLC5/80"
2	Interface	TxtCnst	Comm interface: "KE/KF/Serial", "1784-KT (DH+ Direct)", "1784-KTX (DH+ Direct)", "1784-PCMK (DH+ Direct)", "1784-KTX (DH485)", "1784-PCMK (DH485)", "S-S 5136-SD", "Ethernet"
3	PLC Address	NumCnst	PLC's address on the network (0–254)
4	Communication alarm priority	NumCnst	Alarm priority level (0–10)
5	Retry attempts	NumCnst	Retries before comm alarm
6	Skips	NumCnst	Update pulse skips between comm attempts when failed
7	Receive timeout	NumCnst	Timeout in milliseconds

Parameter	Name	Type	Description
<b>Serial port parameters. If the interface is serial:</b>			
8	Serial port	TxtCnst	Serial port (such as “COM2”)
9	Data rate	NumCnst	Baud rate
10	Parity	TxtCnst	Parity (“even” or “none”)
11	Error detection	TxtCnst	Error check code (“CRC” or “BCC”)
12	Phone number	TxtCnst, NULL	Phone number (such as “5551212”)
13–14	<NULL>		
15	DF1 protocol	TxtCnst	DF1 protocol comm mode (“half” or “full”)
<b>KT card parameter. If the interface is a card:</b>			
8–12, 15	<NULL>		
13	Card number	TxtCnst	Card number (1 = “Card0”, 2 = “Card1”, 3 = “Card2”, ... , 8 = “Card7”)
<b>Ethernet parameter</b>			
8–13, 15	<NULL>		
14	IP address	TxtCnst, NULL	IP address (such as “127.1.1.1”)

## Advantech PCL

Parameter	Name	Type	Description
1	Card I/O port address	TxtCnst or NULL	Board address!; enter a text I/O port address (such as “220”)
2	Scanning interval	NumCnst or NULL	Number of milliseconds between polls (such as 50)
3	AI gain	NumCnst or NULL	Gain; enter 1, 2, 4, 8, or 16
4	alarm priority	NumCnst or NULL	Alarm level (such as 8)

## Applicom Local

Parameter	Name	Type	Description
1	Board Id	NumCnst	Board ID (such as 1)
2	Not used	NULL	Not used for Applicom Local
3	Not used	NULL	Not used for Applicom Local
4	Scanning interval (ms)	NumCnst	Number of milliseconds between polls
5	Communication alarm priority	NumCnst	Alarm level
6	Not used	NULL	Not used for Applicom Local
7	Address of status word	NumCnst	Address of status word in Local mode

## Applicom

Parameter	Name	Type	Description
1	Board Id	NumCnst	Board ID (such as 1)
2	Channel Id	NumCnst	Channel ID
3	Equipment Id	NumCnst	Equipment ID
4	Scanning interval (ms)	NumCnst	Number of milliseconds between polls
5	Communication alarm priority	NumCnst	Alarm level
6	Retry attempts before failure	NumCnst	Number of retry attempts before failure

## Aquatrol

Parameter	Name	Type	Description
1	Model	TxtCnst	PLC model (“W1500”)
2	Address	NumCnst	PLC address
3	Communication alarm priority	NumCnst	Alarm priority level (0–10)
4	Retry attempts	NumCnst	Retries before comm alarm
5	Skips	NumCnst	Update pulse skips between comm attempts when failed
6	Receive timeout	NumCnst	Timeout in milliseconds
7	Serial port	TxtCnst	Serial port (such as “COM2”)
8	Baud Rate	NumCnst	Baud rate
9	Parity	TxtCnst	Parity
10	Data bits	NumCnst	Data bits
11	Stop bits	NumCnst	Stop bits
12	Phone	TxtCnst or NULL	Phone number (such as “5551212”)
13	Digitals In	NumCnst	RTU Configuration, digital inputs
14	Digitals Out	NumCnst	RTU Configuration, digital outputs
15	Analogs In	NumCnst	RTU Configuration, analog inputs
16	Analogs Out	NumCnst	RTU Configuration, analog outputs
17	Start Counters	NumCnst	RTU Configuration, start counters
18	Runtime Counters	NumCnst	RTU Configuration, runtime counters
19	Totalizers	NumCnst	RTU Configuration, totalizers
20	Repeater address	NumCnst or NULL	Repeater address; not used if left blank



## ASCII

Parameter	Name	Type	Description
1	Dummy0	N/A	Leave this blank
2	Dummy1	N/A	Leave this blank
3	Comm Alarm Priority	NumCnst	Alarm priority level (0–10)
4	Retry attempts	NumCnst	Number of retries before comm alarm (such as 4)
5	Skip poll requests	NumCnst	Skip so many subsequent polls when comm failed (such as 5)
6	Receive timeout	NumCnst	Timeout in milliseconds (such as 250)
7	Serial port	TxtCnst	Serial port (such as “COM2”)
8	Baud Rate	NumCnst	Baud rate (such as 1200)
9	Parity	TxtCnst	Default is “none” (“odd”, “even”, “mark”, “space”)
10	Data bits	NumCnst	Number of data bits (such as 8)
11	Stop bits	NumCnst	Number of stop bits (such as 1)
12	Phone number	TxtCnst or NULL	Phone number (such as “91234567”)
13	Monitor serial port	LogConst	Specifies whether you can receive unsolicited frames 0 = no 1 = yes

## Cutler-Hammer

Parameter	Name	Type	Description
1	PLC Model	TxtCnst	PLC model (“D50” or “D300”)
2	Address	NumCnst	PLC address (0–255)
3	Communications alarm priority	NumCnst	Alarm priority level (0–10)

Parameter	Name	Type	Description
4	Retry attempts	NumCnst	Retries before comm alarm
5	Skips	NumCnst	Update pulse skips between comm attempts when failed
6	Receive timeout	NumCnst	Timeout in milliseconds
7	Serial port	TxtCnst	Serial port (such as “COM2”)
8	Baud Rate	NumCnst	Baud rate (1200, 2400, 4800, 9600, 19200)
9	Parity	TxtCnst	Parity (“None”, “Even”, “Odd”)
10	Phone number	TxtCnst, NULL	Phone number (such as “5551212”)
11	Stop bits	NumCnst	Stop bits (1 bit = 0, 2 bits = 2)
12	Data bits	NumCnst	Data bits (7 or 8)

## DeltaTau

Parameter	Name	Type	Description
1	Card base address	TxtCnst	Board address; enter a string (such as “D000”)
2	Scanning interval	NumCnst	Number of milliseconds between polls; enter an integer
3	alarm priority	NumCnst	Alarm level (such as 8)

## DL205/DL405

Parameter	Name	Type	Description
1	Model	TxtCnst	PLC model (such as “DL230”)
2	PLC Address	TxtCnst	PLC’s address on the network (such as “1”)
3	Alarm priority	NumCnst	Alarm priority level (such as 5)
4	Retries	NumCnst	Retries before comm alarm

Parameter	Name	Type	Description
5	Skip	NumCnst	Number of poll requests skipped after comm failure
6	Receive Timeout	NumCnst	Timeout in milliseconds
7	Port	TxtCnst	Serial port (such as "COM2")
8	Data rate	NumCnst	Baud rate
9	Parity	TxtCnst	Parity (such as "even", "odd", "none")
10	Stop bits	NumCnst	Stop bits (such as 1, 2)
11	Data bits	NumCnst	Data bits (such as 7, 8)
12	Phone number	TxtCnst or NULL	Phone number (such as "5551212")
13	Protocol	TxtCnst	Protocol (such as "Upper Port (k)")

## DeviceNet

Parameter	Name	Type	Description
1	MAC ID	NumCnst	MAC ID of DeviceNet device; enter the proper number
2	Connection type	NumCnst	Device connection type 0 = poll 1 = strobe 2 = COS 3 = cyclic
3	I/O Input length	NumCnst or NULL	I/O input length; enter a number (such as 2)
4	I/O Output length	NumCnst or NULL	I/O output length; enter a number (such as 0)
5	Expected Packet Rate	NumCnst or NULL	Expected packet rate, enter a number
6	Alarm priority	NumCnst	Alarm level 1–10
7	Skips	NumCnst	How many polls to skip when communication fails

Parameter	Name	Type	Description
8	Interface number	NumCnst	Interface number
9	Receive Timeout	NumCnst or NULL	Timeout (DeviceNet Explicit only); enter a number (represents milliseconds)
10	Service code	NumCnst or NULL	Service Code (DeviceNet Explicit only); range is 0–255
11	Class ID	NumCnst or NULL	Class ID (DeviceNet Explicit only); range is 0–FFFFFF

## DNP

Parameter	Name	Type	Description
1	Communications alarm priority	NumCnst	Alarm priority level (0–10)
2	Retry attempts	NumCnst	Retries before comm alarm
3	Skips	NumCnst	Update pulse skips between comm attempts when failed
4	Receive timeout	NumCnst	Timeout in milliseconds
5	Serial port	TxtCnst	Serial port (such as “COM2”)
6	Baud Rate	NumCnst	Baud rate (1200, 2400, 4800, 9600, 19200, 38400)
7	Parity	TxtCnst	Parity (“None”, “Even”, “Odd”)
8	Data bits	NumCnst	Data bits (7 or 8)
9	Stop bits	NumCnst	Stop bits (1 bit = 0, 2 bits = 2)
10	Phone number	TxtCnst, NULL	Phone number (such as “5551212”)
11	Address	NumCnst	Destination address
12	Source Address	NumCnst	Source address (0–255)

## Dynamic

Parameter	Name	Type	Description
1	Address	NumCnst	RTU Dynamic address (1 to 254)
2	Port	TxtCnst	Serial port (such as "COM2")
3	Data rate	NumCnst	Baud rate; default is 9600
4	Parity	TxtCnst	Parity (such as "odd")
5	Data bits	NumCnst	Data bits (such as 8)
6	Stop bits	NumCnst	Stop bits (such as 1)
7	Phone	TxtCnst	Phone number (such as "5555555")
8	Priority	NumCnst	Alarm priority (such as 10)
9	Retries	NumCnst	Retries before communications alarm

## Fatek MA/MB/MC

Parameter	Name	Type	Description
1	PLC Model	TxtCnst	PLC Model: "FB-20MA", "FB-28MA", "FB-40MA", "FB-20MB", "FB-28MB", "FB-40MB", "FB-20MC", "FB-28MC", "FB-40MC"
2	Station	NumCnst	Station number (such as "1")
3	Communication alarm priority	NumCnst	Communication alarm priority
4	Retry attempts	NumCnst	Retry attempts
5	Skips	NumCnst	Skips
6	Receive timeout	NumCnst	Receive timeout
7	Serial port	TxtCnst	Serial port (such as "COM1")
8	Baud Rate	NumCnst	Baud Rate (Only 9600)
9	Parity	TxtCnst	Parity (Only "Even")

Parameter	Name	Type	Description
10	Data bits	NumCnst	Data bits (Only 7)
11	Stop bits	NumCnst	Stop bits (Only 1)

## Fieldbus

Each of the possible Fieldbus objects uses the same set of parameters.

Parameter	Name	Type	Description
1	Fieldbus Tag	TxtCnst	Enter the fieldbus tag you want this object to connect to (such as “tagname”)
2	Device Description	TxtCnst	In the dialog box, you select this parameter from the list of Device Descriptions on your computer. Enter a string (such as “+\\data\\nifb”).
3	Alarm priority	NumCnst	Enter a numeric constant (such as 8)
4	PollRate	TxtCnst	Enter a Lookout time string (such as “0:00.5”)
5	Retry Attempts	NumCnst	Enter a number (such as 3)

## FieldPoint

Parameter	Name	Type	Description
1	Ignore this parameter	N/A	Always leave blank
2	Communication alarm priority	NumCnst	Alarm priority level (0–10)
3	Retry	NumCnst	Retries before comm alarm
4	Skip	NumCnst	Update pulse skips between comm attempts when failed
5	Receive timeout	NumCnst	Timeout in milliseconds
6	Serial port	TxtCnst or NULL	Serial port (such as “COM2”)

Parameter	Name	Type	Description
7	Data rate	NumCnst or NULL	Baud rate
8	Checksum mode	NumCnst or NULL	Always has value of 1
9	Phone number	TxtCnst or NULL	Phone number, for serial communications (such as “5551212”)
10	IAK Configuration file	TxtCnst or NULL	Path to the IAK Configuration File generated by FieldPoint Explorer (such as \path...)
11	Import alias information	NumCnst or NULL	Import alias information from IAK file (no=0, yes=1)
12	Object type	NumCnst or NULL	Object type (serial=0, ethernet=1)
13	Address	TxtCnst or NULL	Ethernet address (such as “127.1.1.1”)

## FisherROC

Parameter	Name	Type	Description
1	Controller Model	TxtCnst	PLC model (such as “ROC364”)
2	Group	NumCnst	PLC’s group assignment; range is 0–255
3	Address	NumCnst	PLC’s address on the network; range is 0-255
4	Alarm priority	NumCnst	Alarm priority level (0–10)
5	Retry attempts	NumCnst	Number of retries before comm alarm
6	Skips	NumCnst	Number of poll requests skipped after comm failure
7	Receive Timeout	NumCnst	Timeout in milliseconds (such as 500)
8	Port	TxtCnst	Serial port (such as “COM2”)
9	Data Rate	NumCnst	Baud rate (such as 9600)
10	Parity	TxtCnst	Parity (“even”, “odd”, “none”)

Parameter	Name	Type	Description
11	Stop Bits	NumCnst	Stop bits (such as 1, 2)
12	Data Bits	NumCnst	Data bits (such as 7, 8)
13	Phone number	TxtCnst or NULL	Phone number (such as “5551212”) ** You only see this parameter in the list if you initially had a phone number configured. Is this expected behavior?

## GE Series 90

Parameter	Name	Type	Description
1	Model	TxtCnst	PLC model (“90-30”, “90-70”)
2	PLC Address	TxtCnst or NULL	PLC’s address on the network (such as “1”)
3	Communication alarm priority	NumCnst	Alarm priority level (0–10)
4	Retry attempts	NumCnst	Retries before comm alarm
5	Skips	NumCnst	Update pulse skips between comm attempts when failed
6	Receive timeout	NumCnst	Timeout in milliseconds
7	Serial port	TxtCnst	Serial port (such as “COM2”)
8	Data rate	NumCnst	Baud rate
9	Parity	TxtCnst	Parity (“even”, “odd”, “none”)
10	Stop bits	NumCnst	Stop bits (1 bit = 0, 2-bit = 2)
11	Data bits	NumCnst	Data bits (7 or 8)
12	Phone number	TxtCnst or NULL	Phone number (such as “5551212”)
13	Protocol	TxtCnst	Protocol (“SNPX”, “Ethernet”)
14	TCP/IP Address	TxtCnst or NULL	Internet Protocol address (such as “127.1.1.1”)



## Hitachi

Parameter	Name	Type	Description
1	Model	TxtCnst	PLC model (“CPU22-02HB”, “CPU22-02HC”)
2	Communication alarm priority	NumCnst	Alarm priority level (0–10)
3	Retry attempts	NumCnst	Retries before comm alarm
4	Skips	NumCnst	Update pulse skips between comm attempts when failed
5	Receive timeout	NumCnst	Timeout in milliseconds
6	Serial Port	TxtCnst	Serial port (such as “COM2”)
7	Baud Rate	NumCnst	Baud rate (1200, 2400, 4800, 9600, 19200, 38400)
8	Parity	TxtCnst	Parity (“None”, “Odd”, “Even”)
9	Data bits	NumCnst	Data bits (7 or 8)
10	Stop bits	NumCnst	Stop bits (1, 1.5, or 2)
11	Phone number	TxtCnst, NULL	Phone number
12	Timeout	NumCnst	Value for Timeout
13	Loop	NumCnst	Value for Loop
14	Unit	NumCnst	Unit number
15	Module	NumCnst	Module number
16	Port	NumCnst	Hitachi port number

## IPASCII

Parameter	Name	Type	Description
1	Comm Alarm Priority	NumCnst	Alarm priority level (0–10)
2	Retry attempts	NumCnst	Number of retries before comm alarm (such as 4)

Parameter	Name	Type	Description
3	Skip poll requests	NumCnst	Skip so many subsequent polls when comm failed (such as 5)
4	Receive timeout	NumCnst	Timeout in milliseconds (such as 500)
5	IP address	TxtCnst	IP address of the device (such as "130.164.44.4" or "machine_name")
6	Port	TxtCnst or NULL	Optional port number (such as "2345")
7	Accept unsolicited messages	LogConst	Accept unsolicited messages (such as yes or no)
8	Mode	NumCnst or NULL	Optional: TCP or UDP 0 = TCP 1 = UDP
9	Local port	TxtCnst or NULL	Optional: Local port number (such as "8468")

## Mitsubishi

Parameter	Name	Type	Description
1	PLC Model	TxtCnst	PLC model (such as "A1", "A2", "A2U")
2	Address	NumCnst	PLC address; 0–255
3	Alarm priority	NumCnst	Alarm priority level (0–10)
4	Retries	NumCnst	Retries before comm alarm
5	Skips	NumCnst	Number of poll requests skipped after comm failure
6	Receive Timeout	NumCnst	Timeout in milliseconds
7	Serial Port	TxtCnst	Serial port (such as "COM2")
8	Data Rate	NumCnst	Baud rate
9	Parity	TxtCnst	Parity (such as "odd", "even", "none")
10	Phone number	TxtCnst or NULL	Phone number (such as "5551212")

Parameter	Name	Type	Description
11	Stop Bit	NumCnst	Stop bits (such as 1,2)
12	Data Bit	NumCnst	Data bits (such as 7,8)
13	FX Mode	NumCnst or NULL	FX Mode, 0 = Direct 1 = Multi-drop (Available only on FX object)
14	Protocol	NumCnst or NULL	Protocol (such as 1,4) (Available only on FX object)

## Mitsubishi CLM

Parameter	Name	Type	Description
1	PLC Model	TxtCnst	PLC model (such as "A1")
2	Address	NumCnst	PLC address
3	Alarm priority	NumCnst	Alarm priority level (0–10)
4	Retries	NumCnst	Retries before comm alarm
5	Skips	NumCnst	Number of poll requests skipped after comm failure
6	Timeout	NumCnst	Timeout in milliseconds
7	Port	TxtCnst	Serial port (such as "COM2")
8	Data Rate	NumCnst	Baud rate (such as 19200)
9	Parity	TxtCnst	Parity (such as "even", "odd", "none")
10	Stop Bit	NumCnst	Stop bits (such as 0,1)
11	Data Bit	NumCnst	Data bits (such as 7,8)
12	Protocol	NumCnst or NULL	Protocol mode (such as 1); currently supporting "Control Format 1" only
13	Phone	TxtCnst or NULL	Phone number (such as "5551212"); only exposed in CB if phone number present

## Modbus and Modbus MOSCAD

Parameter	Name	Type	Description
1	Address	NumCnst or TxtCnst	Slave address—0 to 254 (modbus) or text string (mb+)
2	Serial port	TxtCnst	Serial port (such as “COM2”)
3	Data rate	NumCnst	Baud rate (such as 9600)
4	Parity	TxtCnst	Parity (“none”, “odd”, “even”, “mark”, “space”)
5	Data bits	NumCnst	Data bits (such as 7 or 8)
6	Stop bits	NumCnst	Stop bits (such as 1, 1.5, or 2)
7	Phone	TxtCnst or NULL	Phone number (such as “5551212”)
8	Read Coils	NumCnst	Advanced Option—maximum coils with function code 1; default is 2000
9	Read discrete inputs	NumCnst	Advanced Option—maximum discrete inputs with function code 2; default is 2000
10	Read Holding regs	NumCnst	Advanced Option—maximum holding regs with function code 3; default is 125
11	Read input regs	NumCnst	Advanced Option—maximum input regs with function code 4; default is 125
12	Force coils	NumCnst	Advanced Option—maximum coil writes with function code 15; default is 800
13	Preset regs	NumCnst	Advanced Option—maximum holding reg writes with function code 16; default is 100
14	Alarm priority	NumCnst	Alarm priority level (0–10)
15	Retries	NumCnst	Retries before comm alarm
16	Skip	NumCnst	Advanced Option—number of poll requests to skip after communications failure; default is 4
17	Receive timeout	NumCnst	Timeout in milliseconds; default is 500

Parameter	Name	Type	Description
18	Immediately write updates	LogCnst	Advanced Option—TRUE if update outputs, FALSE otherwise; default is true
19	Treat holding registers...	LogCnst or NULL	Advanced Option—TRUE if 32-bit holding registers, FALSE otherwise; default is false
20	...32-bit floating order...	LogCnst or NULL	Advanced Option—TRUE if swap 32-bit holding registers, FALSE otherwise; default is NULL.
21	Poll on receipt...	LogCnst or NULL	Advanced Option—TRUE if we should accept correct unsolicited frames w/ our address and schedule a poll; default is NULL
22	Mode	NumCnst	0 = Serial 1 = Modbus plus 2 = or Ethernet

## Modbus Slave

Parameter	Name	Type	Description
1	Address	NumCnst	Slave address (1 to 255)
2	Serial port	TxtCnst	Serial port (such as “COM2”)
3	Data rate	NumCnst	Baud rate; default is 9600
4	Parity	TxtCnst	Parity (text); default is “none” (“odd”, “even”, “mark”, “pace”)
5	Data bits	NumCnst	Data bits; default is 8 (not accessible through the create object dialog box)
6	Stop bits	NumCnst	Stop bits; default is 1 (1.5, 2)

## Modbus Daniel

Parameter	Name	Type	Description
1	Device ID	NumCnst	Address (such as 1)
2	Serial port	TxtCnst	Serial port (such as “COM2”)
3	Data rate	NumCnst	Baud rate (such as 9600)
4	Parity	TxtCnst	Parity: (“none”, “odd”, “even”, “mark”, “space”)
5	Data bits	NumCnst	Data bits (such as 7 or 8)
6	Stop bits	NumCnst	Stop bits (such as 1, 1.5, or 2)
7	Phone	TxtCnst or NULL	Phone number (such as “5555555”)
8	Read Coils	NumCnst	Advanced Option—maximum coils with function code 1; default is 2000
9	Read discrete inputs	NumCnst	Advanced Option—maximum discrete inputs with function code 2; default is 2000
10	Read Holding regs	NumCnst	Advanced Option—maximum holding regs with function code 3; default is 125
11	Read input regs	NumCnst	Advanced Option—maximum input regs with function code 4; default is 125
12	Force coils	NumCnst	Advanced Option—maximum coil writes with function code 15; default is 800
13	Preset regs	NumCnst	Advanced Option—maximum holding reg writes with function code 16; default is 100
14	Alarm priority	NumCnst	Alarm priority level (0–10)
15	Retries	NumCnst	Retries before comm alarm
16	Skip	NumCnst	Advanced Option—number of poll requests to skip after communications failure; default is 4
17	Receive timeout	NumCnst	Timeout in milliseconds; default is 500

Parameter	Name	Type	Description
18	Immediately write updates	LogCnst	Advanced Option—TRUE if update outputs, FALSE otherwise; default is true
19	Poll on receipt	LogCnst or NULL	Advanced Option—TRUE if we should accept correct unsolicited frames w/ our address and schedule a poll; default is NULL

## Modbus OmniFlow

Parameter	Name	Type	Description
1	Device ID	NumCnst	Address (such as 1)
2	Alarm priority	NumCnst	Alarm priority level (0–10)
3	Retry attempts	NumCnst	Retries before comm alarm
4	Skip	NumCnst	Number of poll requests to skip after communications failure
5	Receive timeout	NumCnst	Timeout in milliseconds (such as 750)
6	Serial port	TxtCnst	Serial port (such as “COM2”)
7	Baud rate	NumCnst	Baud rate; default is 9600
8	Parity	TxtCnst	Parity; default is “none” (“odd”, “even”, “mark”, “space”)
9	Data bits	NumCnst	Data bits; default is 8
10	Stop bits	NumCnst	Stop bits; default is 1
11	Phone	TxtCnst or NULL	Phone number (such as “5555555”)

## NI-DAQ

Parameter	Name	Type	Description
1	Device	NumCnst	Board ID
2	Channel	NumCnst or NULL	AI channel for SCXI (NULL for board)

Parameter	Name	Type	Description
3	Chassis	NumCnst or NULL	Chassis ID for SCXI (NULL for board)
4	Scan rate	NumCnst	Scan rate for AI's, DI's in milliseconds
5	Priority	NumCnst	Alarm level

## Omron

Parameter	Name	Type	Description
1	Model	TxtCnst	PLC model (such as "C20")
2	Address	TxtCnst or NULL	PLC address (such as "00")
3	Alarm priority	NumCnst	Alarm priority level (0–10)
4	Retries	NumCnst	Retries before comm alarm
5	Skips	NumCnst	Number of poll requests skipped after comm failure
6	Timeout	NumCnst	Timeout in milliseconds
7	Port	TxtCnst or NULL	Serial port (such as "COM2")
8	Baud Rate	NumCnst	Baud rate (such as 9600)
9	Parity	TxtCnst	Parity (such as "even", "odd", "none")
10	Phone number	TxtCnst or NULL	Phone number (such as "5551212")
11	Data Bits	NumCnst	Data bits (such as 7,8)
12	Stop Bits	NumCnst	Stop bits (such as 1,2)



## OPC Client

Parameter	Name	Type	Description
1	Server Name	TxtCnst	Registered Program ID of OPC Server (such as “National Instruments.DaqOpc”)
2	Alarm Level	NumCnst	Alarm priority level (0–10)
3	SKIP	NULL	Parameter ignored. Included for backward compatibility
4	Read Cache	NULL	Parameter ignored. Included for backward compatibility
5	Group Update Rate	TxtCnst	Rate at which OPC Server should update the cache, in milliseconds
6	Remote Server	TxtCnst	Computer name for remote server (such as “\\TRIPPER”)
7	Server Type	NumCnst	Type of server (any combo of in-process, local, or remote) 0 = In-Process Server 1 = Local Server 2 = Remote Server
8	Deadband	NumCnst	OPC Group deadband, expressed as a percentage (enter an integer)
9	Browsing	NumCnst/NULL	Browsing settings 0 = Flat 1 = Hierarchical 2 = Disabled
10	Default Access Path	TxtCnst/NULL	Default access path
11	Async	NumCnst/NULL	Whether or not to use asynchronous I/O; 1 = yes 0 = no
12	Force	NumCnst/NULL	Whether to force a refresh after write 1 = yes 0 = no

## Opto Host Words

Parameter	Name	Type	Description
1	Alarm Priority	NumCnst	Alarm priority level (0–10)
2	Retry attempts	NumCnst	Retries before comm alarm
3	Skips	NumCnst	Update pulse skips between comm attempts when failed
4	Receive timeout	NumCnst	Timeout in milliseconds
5	Address	NumCnst or TxtCnst	IP address (text) or serial network address (numeric)
6	Medium	NumCnst	Serial or ethernet. Enter 0 for serial, 1 for ethernet.
7	Port	TxtCnst	Serial port (such as “COM1”)
8	Baudrate	NumCnst	Baud rate; default is 115200
9	Phone	TxtCnst or NULL	Phone number

## OptoMistic

Parameter	Name	Type	Description
1	Alarm priority	NumCnst	Alarm priority level (0–10)
2	Retries	NumCnst	Retries before comm alarm
3	Skips	NumCnst	Number of poll requests skipped after comm failure
4	Timeout	NumCnst	Timeout in milliseconds
5	Serial Port	TxtCnst	Serial port (such as “COM2”)
6	Baud Rate	NumCnst	Baud rate

Parameter	Name	Type	Description
7	Checksum select	NumCnst	Checksum select, 0 = Checksum 1 = CRC16
8	Phone	TxtCnst or NULL	Phone number, such as “5551212” (Only exposed when a phone number is present. Otherwise, this parameter does not appear.)

## Optomux

Parameter	Name	Type	Description
1	PLC Model	TxtCnst	PLC model (“Optomux”)
2	Communication alarm priority	NumCnst	Alarm priority level (0–10)
3	Retry attempts	NumCnst	Retries before comm alarm
4	Skips	NumCnst	Update pulse skips between comm attempts when failed
5	Receive timeout	NumCnst	Timeout in milliseconds
6	Serial port	TxtCnst	Serial port (such as “COM2”)
7	Data rate	NumCnst	Baud rate
8	Protocol Select	NumCnst	Protocol select (Standard = 0, Enhanced = 1)
9	Phone number	TxtCnst or NULL	Phone number (such as “5551212”)

## Philips

Parameter	Name	Type	Description
1	PLC Model	TxtCnst	PLC Model (“P8-Compact Line”, “P8-Rack Line”)
2	Address	TxtCnst	PLC address

Parameter	Name	Type	Description
3	Communication alarm priority	NumCnst	Alarm priority level (0–10)
4	Retry attempts	NumCnst	Retries before comm alarm
5	Skips	NumCnst	Update pulse skips between comm attempts when failed
6	Receive timeout	NumCnst	Timeout in milliseconds (greater than 250 ms)
7	Serial port	TxtCnst	Serial port (such as “COM2”)
8	Baud Rate	NumCnst	Baud rate (1200, 2400, 4800, 9600, 19200)
9	Parity	TxtCnst	Parity (only takes value of “Even”)
10	Phone number	TxtCnst, NULL	Phone number (such as “5551212”)
11	Data bits	NumCnst	Data bits (only takes value of 8)
12	Stop bits	NumCnst	Stop bits (only takes value of 2)

## Phoneducer

Parameter	Name	Type	Description
1	Serial port	NumCnst	Serial port (such as “COM2”)
2	Baudrate	NumCnst	Baud rate (such as 1200)
3	Parity	TxtCnst	Default is “none” (“odd”, “even”, “mark”, “space”)
4	Data bits	NumCnst	Number of data bits (such as 8)
5	Stop bits	NumCnst	Number of stop bits 0 = 1 stop bit 2 = 2 stop bits
6	Phone number	TxtCnst	Phone number (such as “5555555”)
7	Alarm priority	NumCnst	Alarm priority level (0–10)

Parameter	Name	Type	Description
8	Receive timeout	NumCnst	Timeout in seconds (such as 10)
9	Skip	NumCnst	Number of poll requests to skip after communications failure

## Profibus DP

Parameter	Name	Type	Description
1	Slave Address	NumCnst	Profibus slave address for the device this object is supposed to communicate
2	Designation	N/A	This parameter remains for compatibility purposes only and should be left blank if it appears.
3	Alarm level	NumCnst	Sets the alarm priority level for this object
4	Medium	TxtCnst	The ComET200 binary file this object is supposed to use, including the full path to the file

## Profibus L2

Parameter	Name	Type	Description
1	Alarm priority	NumCnst	Alarm priority level (0–10)
2	PLC network address	NumCnst	Network address of the device this object is intended to control
3	Retry attempts	NumCnst	The number of times Lookout attempts to establish communications with a device if it is not getting a valid response.

Look like parameters in the dialog box, but are contained in the Profil2.ini file as shown below:

File Item	Parameter Name
[S&SPfbCard]	N/A
TokenRotationTime=5000	Token Rotation Time
SlotTime=323	Slot time
ReadyTime=13	Ready Time
IdleTime1=37	Idle Time 1
IdleTime2=40	Idle Time 2
CardPfbAddress=31	Card Network Address
HighPfbAddress=22	Network High Address
CardMemAddress=D000	Card Memory Address
CardPortAddress=250	Base Port Address
BaudRate=9	Network Baud Rate; uses values 0–9 to set rates as follows 0 = 9600 1 = 19200 2 = 93.75K 3 = 187.5K 4 = 500K 5 = 750K 6 = 1.5M 7 = 3M 8 = 6M 9 = 12M

## RELIANCE

Parameter	Name	Type	Description
1	Interface	NumCnst	Comm interface (PC-Link) (Only accepts a value of 2)
2	Communication alarm priority	NumCnst	Alarm priority level (0–10)

Parameter	Name	Type	Description
3	Retry attempts	NumCnst	Retries before comm alarm
4	Skips	NumCnst	Update pulse skips between comm attempts when failed
5	Receive timeout	NumCnst	Timeout in milliseconds
6	Port Address	TxtCnst	Port Address (Irrelevant for this object. "COM1" is suggested.)
7	Baud rate	NumCnst	Baud rate (Irrelevant for this object. A value of 9600 is suggested.)
8	Parity	TxtCnst	Parity (Irrelevant for this object. "Even" is suggested.)
9	Stop bits	NumCnst	Stop bits (Irrelevant for this object. A value of 0 is suggested.)
10	Data bits	NumCnst	Data bits (Irrelevant for this object. A value of 8 is suggested.)
11	Phone number	TxtCnst or NULL	Phone number (Irrelevant for this object. A value of <NULL> is suggested.)
12	Node ID	NumCnst	Node ID of PLC on the R-Net
13	Slot ID	NumCnst	Rack slot number of PLC
14	RESERVED	N/A	Do not modify.
15	RESERVED	N/A	Do not modify.

## RKC F Series

Parameter	Name	Type	Description
1	PLC Model	TxtCnst	PLC model ("REX-F400", "REX-F700", "REX-F90")
2	Address	NumCnst	PLC address (0–31)
3	Communications alarm priority	NumCnst	Alarm priority level (0–10)
4	Retry attempts	NumCnst	Retries before comm alarm

Parameter	Name	Type	Description
5	Skips	NumCnst	Update pulse skips between comm attempts when failed
6	Receive timeout	NumCnst	Timeout in milliseconds
7	Serial port	TxtCnst	Serial port (such as “COM2”)
8	Baud Rate	NumCnst	Baud rate (1200, 2400, 4800, 9600, 19200)
9	Parity	TxtCnst	Parity (“None”, “Even”, “Odd”)
10	Phone number	TxtCnst, NULL	Phone number (such as “5551212”)
11	Stop bits	NumCnst	Stop bits (1 bit = 0, 2 bits = 2)
12	Data bits	NumCnst	Data bits (7 or 8)

## Scan-Data

Parameter	Name	Type	Description
1	Station ID	NumCnst	Device address
2	Communication alarm priority	NumCnst	Alarm priority level (0–10)
3	Retry attempts	NumCnst	Retries before comm alarm
4	Skip	NumCnst	Number of poll requests to skip after communications failure
5	Receive timeout	NumCnst	Timeout in milliseconds
6	Port	TxtCnst	Serial port (such as COM2)
7	Baudrate	NumCnst	Baud rate (default is 1200)
8	Parity	TxtCnst	Parity; default is Even
9	Data Bits	NumCnst	Default is 7
10	Stopbit	NumCnst	Default is 1



Parameter	Name	Type	Description
11	Protocol	TxtCnst	Choose ScanData protocol. Enter NNNN????NNNN for B:LMX NNNN????NNNN for C:SMR & M-system
12	Phone	TxtCnst or NULL	Phone number

## NI-SCXI

Parameter	Name	Type	Description
1	Board id	NumCnst	Board ID
2	Scanning interval	NumCnst	Scanning interval for channel list
3	Alarm priority	NumCnst	Alarm level

## Siemens S5\_AS511

Parameter	Name	Type	Description
1	Alarm priority	NumCnst	Alarm priority (such as 8)
2	Retry attempts	NumCnst	Enter a number (such as 5)
3	Skips	NumCnst	Enter a number (such as 5)
4	Receive timeout	NumCnst	Timeout in milliseconds
5	Serial Port	TxtCnst	Serial port (such as "COM2")
6	Baud rate	NumCnst	Baud rate (such as 9600)
7	Phone number	TxtCnst or NULL	Phone number (such as "5551212")
8	PLC Model	TxtCnst	PLC model (such as "95U")

## Siemens S5\_3964

Parameter	Name	Type	Description
1	PLC Model	TxtCnst	PLC model (such as “100U”)
2	Alarm priority	NumCnst	Alarm priority level (0–10)
3	Retries	NumCnst	Retries before comm alarm
4	Skips	NumCnst	Number of poll requests skipped after comm failure
5	Timeout	NumCnst	Timeout in milliseconds
6	Port	TxtCnst	Serial port (such as “COM2”)
7	Baud rate	NumCnst	Baud rate
8	Phone	TxtCnst or NULL	Phone number (such as “5551212”)
9	Protocol	TxtCnst	Protocol (such as “3964”, “3964R”)

## Siemens S7 HMI

Parameter	Name	Type	Description
1	MPI Address (CPU)	NumCnst	MPI Address (CPU)
2	Model	TxtCnst	PLC model (“S7-300”, “S7-400”)
3	Serial port	TxtCnst	Serial port (such as “COM2”)
4	Baud Rate	NumCnst	Baud rate
5	Communication alarm priority	NumCnst	Alarm priority level (0–10)
6	Retry attempts	NumCnst	Retries before comm alarm
7	Skips	NumCnst	Update pulse skips between comm attempts when failed
8	Receive timeout	NumCnst	Timeout in milliseconds
9	Phone	TxtCnst or NULL	Phone number (such as “5555555” or <NULL>)

## Siemens TI/505

Parameter	Name	Type	Description
1	PLC model	TxtCnst	PLC model (such as “TI545”, “TI565”, etc.)
2	Interface	TxtCnst	Interface (such as “Sinec TF”)
3	Application Association	TxtCnst	PLC’s Application Association “AFP5”
4	Alarm Level	NumCnst or NULL	Alarm priority level (0–10)
5	Retries	NumCnst	Retries before comm alarm
6	Skips	NumCnst	Number of poll requests skipped after comm failure
7	Receive Timeout	NumCnst	Timeout in milliseconds

## Sixnet

Parameter	Name	Type	Description
1	Station name	TxtCnst	Station name (such as “station1”)
2	Communication alarm priority	NumCnst	Communication alarm priority (0–10)

## Square-D

Parameter	Name	Type	Description
1	PLC model	TxtCnst	PLC model (such as “SCP-1xx”) “SCP-3xx” “SCP-4xx” “SCP-5xx” “SCP-6xx” “SCP-7xx”
2	Route	TxtCnst or NULL	PLC network route information (such as “1”)

Parameter	Name	Type	Description
3	Alarm priority level	NumCnst	Alarm priority level from 0 to 10
4	Retries before comm alarm	NumCnst	Retries before comm alarm (such as 4)
5	Skip Every N Poll requests	NumCnst	After communications, for example 5
6	Receive Timeout	NumCnst	in milliseconds (such as 2502)
7	Serial port	TxtCnst	Serial port (such as “COM2”). Only applies to serial interface versions (see parameter12, Interface)
8	Data Rate	NumCnst	Baud rate(Does not apply to SY/ENET), (such as 1200, 2400, 4800, 9600, 19200)
9	Parity	TxtCnst	Parity (Does not apply to SY/ENET); default is “even” (“odd”, “none”)
10	Stop bits	NumCnst	Stop bits; set to 0 for 1 stop bit; set to 2 for 2 stop bits (Does not apply to SY/ENET)
11	Data bits/Word size	NumCnst	Data bits (such as 7 or 8) (Does not apply to SY/ENET)
12	Phone number	TxtCnst or NULL	Phone number (such as “5555555”) (Does not apply to SY/ENET)
13	Interface	TxtCnst	Set to “Serial” “SY/LINK” “SY/ENET”

Parameter	Name	Type	Description
14	Interface	NumCnst	Selected interface in list (not accessible through the create object dialog box) Set to 0 for Serial 1 for SY/LINK 2 for SY/ENET
15	Card Changed	NumCnst	Card reconfigure status (not accessible through the create object dialog box) Set to 0 for Serial 1 for SY/LINK 2 for SY/ENET

## Tesco

Parameter	Name	Type	Description
1	Protocol	NumCnst	Protocol (4 = LIQ4, 5 = LIQ5)
2	Route	TxtCnst	Route (such as "1")
3	Serial port	TxtCnst	Serial port (such as "COM2")
4	Data rate	NumCnst	Data rate (110, 300, 600, 1200, 2400, 4800, 9600, 19200, 38400, 57600, 115200)
5	Parity	TxtCnst	Parity ("even", "odd", "none")
6	Data bits	NULL	Data bits; leave this parameter with a NULL value
7	Stop bits	NumCnst	Stop bits (1 or 2)
8	Phone number	TxtCnst, NULL	Phone number
9	Communication alarm priority	NumCnst	Alarm priority level; leave this parameter with a NULL value
10	Retry attempts	NumCnst	Retries before comm alarm
11	Receive timeout	NumCnst	Timeout in milliseconds
12	Accept quiescent messages	NumCnst	Accept quiescent messages selection (only for LIQ4) (0 = no, 1 = yes)

Parameter	Name	Type	Description
13	Node address	NumCnst	Source node address
14	Skips	NumCnst	Comm fail poll skips

## Tiway (TI500)

Parameter	Name	Type	Description
1	PLC Model	NumCnst	PLC model number (such as 545)
2	Alarm priority	NumCnst	Alarm priority level (0–10)
3	Retry attempts	NumCnst	Retries before comm alarm
4	Skip every X polls	NumCnst	Update pulse skips between comm attempts when failed
5	Receive timeout	NumCnst	Timeout in milliseconds
6	Medium	NumCnst	Comm medium (COMM_LP = 0, COMM_UHA = 1, COMM_PCA = 2, COMM_CTI = 3)
<b>Local port parameters (MEDIUM == COMM_LP):</b>			
7	Serial port	TxtCnst	Serial port (such as “COM2”)
8	Data rate	NumCnst	Baud rate (such as 9600)
9	Phone number	TxtCnst or NULL	Phone number (such as “5551212”)
<b>UHA parameters (MEDIUM == COMM_UHA):</b>			
7	Serial port	TxtCnst	Serial port (such as “COM2”)
8	NIM address	NumCnst	NIM address (1–254)
<b>PCA parameter:</b>			
7	Card	NumCnst	Card number (1–4)
8	NIM address	NumCnst	NIM address (1–254)
<b>CTI parameters (MEDIUM == COMM_CTI):</b>			
7	IP address	TxtCnst	TCP/IP 32-bit address (such as “127.1.1.1”)

For now, we support only one winsock.dll per computer (no support for multiple TCP/IP cards yet).

This is a text string that can use a name service, or #.#.#.# format.

## ToshibaMseries

Parameter	Name	Type	Description
1	PLC model	TxtCnst	Enter "EX100" "M20" "M40"
2	PLC address	TxtCnst	PLC address (such as "00" or "1")
3	Alarm priority level	NumCnst	Alarm priority level from 0 to 10
4	Retries before comm alarm	NumCnst	Retries before comm alarm (such as 4)
5	Skip Every N Poll requests	NumCnst	After communications, for example 5
6	Receive Timeout	NumCnst	In milliseconds (such as 250)
7	Serial port	TxtCnst	Serial port (such as "COM2")
8	Baud rate	NumCnst	Baud rate (such as 1200 or 38400)
9	Parity	TxtCnst	Parity; default is "none" ("odd", "even")
10	Data bits	NumCnst	Data bits; default is 8 (disabled for M series)
11	Stop bits	NumCnst	Stop bits; default is 1(disabled for M series)
12	Phone number	TxtCnst or NULL	(Such as "5555555")

## ToshibaTseries

Parameter	Name	Type	Description
1	PLC model	TxtCnst	Enter "T1" "T2" "T3"
2	PLC address	TxtCnst	PLC address (such as "00" or "1")
3	Alarm priority level	NumCnst	Alarm priority level from 0 to 10
4	Retries before comm alarm	NumCnst	Retries before comm alarm (such as 4)
5	Skip Every N Poll requests	NumCnst	After communications, for example 5
6	Receive Timeout	NumCnst	In milliseconds (such as 250)
7	Serial port	TxtCnst	Serial port (such as "COM2")
8	Baud rate	NumCnst	Baud rate (such as 1200 or 38400)
9	Parity	TxtCnst	Parity; default is "none" ("odd", "even")
10	Data bits	NumCnst	Data bits; default is 8
11	Stop bits	NumCnst	Stop bits; default is 1
12	Phone number	TxtCnst or NULL	(Such as "5555555")

## Wizdom

Parameter	Name	Type	Description
1	ADDRESS	TxtCnst	Board address (such as "D000")
2	INTERRUPT	NumCnst or NULL	Interrupt number (** This isn't in property box to be configured.)
3	PRIORITY	NumCnst	Alarm level (such as 8) LogVar



# Lookout System Objects

---

## Accumulator

Parameter	Name	Type	Description
1	Input	NumCnst or NumVar	Signal to accumulate
2	Sample	LogVar	Signal to trigger accumulation
3	Reset	LogVar	Signal to reset accumulator

## Aggregate

Parameter	Name	Type	Description
1	Definition File to Load	TxtCnst	Qualified path to the L4P file defining the aggregate object; full or relative, depending on your distribution needs.
2-N	user defined	User defined parameters	Parameters you expose when you save a process as an aggregate definition will appear here. Their order depends on your parameter configuration.

## Alarm

Parameter	Name	Type	Description
<b>ALL Alarms have the following parameters:</b>			
1	Message	TxtCnst or TxtVar	Message delivered when alarm conditions apply.
2	Alarm area	TxtCnst or NULL	Alarm area in which to categorize this alarm
3			Signal
	IF Parameter #16 (Type) is Logical, LogVar. IF Parameter #16 (Type) is Numeric, NumVar.		
<b>IF Parameter #16 (Type) is Logical</b>			

Parameter	Name	Type	Description
4	Priority	NumCnst	Alarm priority (must be between 1 & 10)
5	Wave File	txtcnstor NULL	Path to the WAV file you want played for this alarm (must be a full path)
<b>IF Parameter #16 (Type) is Numeric</b>			
4	Lo-Lo level	NumVar or NumCnst	Lo-Lo alarm level
5	Lo-Lo priority	NumCnst	Lo-Lo alarm priority (must be between 1 & 10)
6	Lo level	NumVar or NumCnst	Lo alarm level
7	Lo priority	NumCnst	Lo alarm priority (must be between 1 & 10)
8	Hi level	NumVar or NumCnst	Hi alarm level
9	Hi priority	NumCnst	Hi alarm priority (must be between 1 & 10)
10	Hi-Hi level	NumVar or NumCnst	Hi-Hi alarm level
11	Hi-Hi priority	NumCnst	Hi-Hi alarm priority (must be between 1 & 10)
12	Rate of change	NumVar or NumCnst	Generates an alarm when the signal is actively changing by the set amount for the period of time between any two Sample pulses. Enter a number that relates to the scale of the data you are setting the alarm for.
13	Rate of change priority	NumCnst	Rate of change alarm priority (must be between 1 & 10)
14	Unit time	NumCnst	Enter 1:00 for one minute; this setting used by Rate of change
15	Sample	LogVar	Pulse setting to trigger samples

Parameter	Name	Type	Description
<b>ALL Alarms have the following parameters:</b>			
16	Type	NumCnst	Sets whether this is a logical or numeric alarm Logical = 1 Numeric = 2

## Alternator

Parameter	Name	Type	Description
1	Devices	NumCnst	Maximum number of devices (such as 7)
2	Maximum run time	TxtCnst	The maximum amount of time that any one device is allowed to run continuously (such as "01:05:50:59")
3	Delay between device starts	TxtCnst	The minimum amount of time between device starts (such as "00:05:50:59")
4	Device response time	TxtCnst	Time the alternator waits for a response from a device before activating an alarm, (such as "00:00:50:59")
5	Device failure alarm priority	NumCnst	The priority level of alarms generated by the alternator (such as 5 or 7)
6	Device name	TxtCnst	String describing the type of device (such as "Pumps")
7	Timer update	TxtCnst	Timer used by the alternator for triggering computations (such as "00:00:00:59")

Parameter	Name	Type	Description
8	Operating Mode	NumCnst	Sets the operation mode of the Alternator object.  0= Sequential 1= least Recently used (default) 2= Total Runtime
9	Retry device	LogCnst	Sets the alternator to continue to attempt to turn on a device after an alarm condition has been reported for that device.  0= disabled 1= selected (default)

## Animator

Parameter	Name	Type	Description
1	Graphic file	TxtCnst	Graphic file name and path (such as graphics\box.wmf)
2	Transparent pixel X	NumVar or NULL	Transparent x pos in pixels
3	Transparent pixel Y	NumVar or NULL	Transparent y pos in pixels
4	100% Size (in pixels) - Width	NumCnst	Graphic size 100% width in pixels
5	100% Size (in pixels) - Height	NumCnst	Graphic size 100% height in pixels
Animator page			
6	Signal for position - X	NumCnst, NumVar or NULL	Graphic x location w/r to lower left corner
7	Signal for position - Y	NumCnst, NumVar or NULL	Graphic y location w/r to lower left corner

Parameter	Name	Type	Description
8	Size	NumCnst, NumVar or NULL	Size
9	Visible	LogVar, LogCnst or NULL	Graphic visible or not
10	Rows	NumVar or NULL	Rows in bitmap filmstrip
11	Columns	NumVar or NULL	Columns in bitmap filmstrip
12	Cel or Rate	LogCnst or NULL	Filmstrip rate (cels per second = yes, actual cel selected = no)
13	Cel/Rate	NumCnst, NumVar or NULL	Either cel rate (cels per second) or actual cel to be displayed (modulo this value)
Color conditions and rotation, etc.			
14	Angle	NumCnst or NULL	Graphic angle of rotation (0–360 degrees clockwise from vertical)
15	Mirror	logical or NULL	Mirror image about the vertical axis (yes, no)
16	Grey proximity	NumCnst or NULL	Sensitivity to color tone changes by limiting changed colors to shades of gray (0–100)
17	“If” condition	LogVar, LogCnst or NULL	First color tone change condition
18	“Else if” condition	LogVar, LogCnst or NULL	Second color tone change condition
19	“Else if” condition	LogVar, LogCnst or NULL	Third color tone change condition
20	“Else if” condition	LogVar, LogCnst or NULL	Fourth color tone change condition
21	“Else if” condition	LogVar, LogCnst or NULL	Fifth color tone change condition

Parameter	Name	Type	Description
22	Color	NumCnst or NULL	Color if first condition is met (such as 0xFFFFFFFF or -1 for original color)
23	Color	NumCnst or NULL	Color if second condition is met (such as 0xFFFFFFFF or -1 for original color)
24	Color	NumCnst or NULL	Color if third condition is met (such as 0xFFFFFFFF or -1 for original color)
25	Color	NumCnst or NULL	Color if fourth condition is met (such as 0xFFFFFFFF or -1 for original color)
26	Color1	NumCnst or NULL	Color if fifth condition is met (such as 0xFFFFFFFF or -1 for original color)
27	Color	NumCnst or NULL	Color if previous conditions are false (such as 0xFFFFFFFF or -1 for original color)
28	Use RCPOS	LogCnst	If true AND if x, y, and size are not given, set graphic size to rcPos instead of W and H. (yes, no)

## Average

Parameter	Name	Type	Description
1	Data	NumVar	Signal that you are averaging (such as Pot1.value)
2	Reset	LogVar or NULL	Resets the average to 0 when expression is true, enter a Lookout object (such as Switch1)
3	Enable	LogVar or NULL	Average is calculated when this expression is true, if the parameter is blank, the average is always taken

## Counter

Parameter	Name	Type	Description
1	Count	LogVar	Input to trigger a count (such as Timer1)
2	Reset	LogVar or NULL	Clear all of the counted values (such as Pb2)

## DataSocket

Parameter	Name	Type	Description
1	URL	TxtCnst	URL to the DataSocket data source
2	Access Mode	LogCnst	Yes= read No = write
3	Update Mode	NumCnst	Choose between manual/automatic/poll 0 = Manual 1 = Automatic 2 = Poll
4	Dimensions	TxtCnst	Enabled only when writing data, this parameter specifies the array dimensions if you are writing to a Datasocket array. Use a colon to delimit each dimension of an array. Entering 10:20 tells Lookout that the datasocket will be writing to a 2 dimensional array of ten elements arranged in 20 rows.

## Data Table

Parameter	Name	Type	Description
1	Security level	NumCnst	Security level (0–10)
2	Log events	LogCnst	Log events (yes, no)
3	Service	TxtCnst or NULL	If DDE, what is the name of the service (such as “Excel”)

Parameter	Name	Type	Description
4	Topic	TxtCnst or NULL	If DDE, what is the name of the topic (such as "Sheet1")
5	Item	TxtCnst or NULL	If DDE, what is the name of the item (such as "r1c1")
6	Filename	TxtCnst, TxtVar, NULL	Import/Export file name (such as "tblsmp1.xls")
7	File Type	NumCnst or NULL	Import/Export file type (XLS = 0, ODBC = 1)
8	Alarm priority	NumCnst	Alarm Priority (0–10)
9	Connect String	TxtCnst, TxtVar, NULL	Connect String (such as "SQL string")
10	SQL command	TxtCnst, TxtVar, NULL	SQL Command (such as "SQL command")
11	Clear table if import error	LogCnst	Clear table if import error (yes, no)

## DDELink

Parameter	Name	Type	Description
1	Service	TxtCnst	The application running as a DDE service you want to access (such as EXCEL)
2	Topic	TxtCnst	The topic (such as an Excel file name) that you want to access through the DDE service
3	Item	TxtCnst	The data point you want DDE access to (such as an Excel cell). DDE service does not recognize Excel cell names (such as A1) so you must use a r1c1 (for row 1 column 1) format to specify your data item.



## DDETable

Parameter	Name	Type	Description
1	Service	TxtCnst	DDE Service (such as “Excel”)
2	Topic	TxtCnst	DDE Topic (such as “Book1”)
3	Item	TxtCnst	DDE Item (such as “r1c1:r1c3”)

## Delay Off

Parameter	Name	Type	Description
1	On/Off signal	LogVar or LogCnst	Signal which triggers the countdown of the Delay timer (such as Switch1)
2	Timer delay	NumVar or NumCnst	Delay before the timer goes Off

## Delay On

Parameter	Name	Type	Description
1	On/Off signal	LogVar or LogCnst	Signal to enable/disable timer
2	Timer delay	NumVar or NumCnst	Signal to determine delay
3	Display format	TxtCnst	Display format (such as “dd/mm/yy hh:mm:ss”, “HH:MM”); default is <NULL> parameter for MM:SS.

## Derivative

Parameter	Name	Type	Description
1	Input	NumVar	The numeric input for the derivative function (such as “Pot1”)
2	Time unit	NumCnst	The interval at which a new input value is taken and compared to the previous value; can be any unit of time, but must be entered in standard Lookout time format (such as 1:00 for one minute).
3	Update	NumCnst or LogVar	Input signal to calculate a new rate-of-change value.

## Elapsed Time

Parameter	Name	Type	Description
1	Enable	LogVar	The Expression or signal whose On time is to be totalled
2	Reset	LogVar or NULL	If specified, this will reset the Elapsed timer.

## Event

Parameter	Name	Type	Description
1	Trigger	LogCnst, LogVar	Event trigger
2	Trigger hi text	TxtVar, TxtCnst, NULL	Lo-Hi transition event text
3	Trigger lo text	TxtVar, TxtCnst, NULL	Hi-Lo transition event text

## Flip Flop

Parameter	Name	Type	Description
1	INPUT	LogVar	Input signal (such as Switch1)

## Gauge

Parameter	Name	Type	Description
1	Signal	NumVar or NumCnst	Signal for gauge
2	“If” condition	LogVar or NULL	First condition to evaluate
3	Gauge color	NumCnst or NULL	Color for gauge if first condition is met (such as 0xFFFFFFFF)
4	“Else if” condition	LogVar or NULL	Second condition to evaluate
5	Gauge color	NumCnst or NULL	Color for gauge if second condition is met (such as 0xFFFFFFFF)
6	“Else if” condition	LogVar or NULL	Third condition to evaluate
7	Gauge color	NumCnst or NULL	Color for gauge if third condition is met (such as 0xFFFFFFFF)
8	“Else if” condition	LogVar or NULL	Fourth condition to evaluate
9	Gauge color	NumCnst or NULL	Color for gauge if fourth condition is met (such as 0xFFFFFFFF)
10	“Else if” condition	LogVar or NULL	Fifth condition to evaluate
11	Gauge color	NumCnst or NULL	Color for gauge if fifth condition is met (such as 0xFFFFFFFF)
12	Gauge color	NumCnst or NULL	Color for gauge if previous conditions are false (such as 0xFFFFFFFF)

Parameter	Name	Type	Description
13	Flash	LogVar or LogConst or NULL	Condition to enable flashing
14	Flash Fast	LogConst	Flag to enable fast flashing; (Enabled = yes, Disabled = <NULL>)

## Histogram

Parameter	Name	Type	Description
1	Sampled Signal	NumVar	Signal (such as Waveform.Sine_180)
2	Minimum (Bin settings)	NumVar, NumCnst	Minimum bins (such as 4)
3	Maximum (Bin settings)	NumVar, NumCnst	Maximum bins (such as 10)
4	Number (Bin settings)	NumCnst	Number of bins; default is 8
5	Sample trigger	LogVar	Trigger sample (such as Pulse1)
6	Reset	LogVar or NULL	Reset samples (such as Pb1)
7	Categorize	NumVar, NumCnst, or NULL	For all samples, set to 0; for most recent, set to a number (2-1000)
8	LSL	NumVar or NumCnst	(Such as 20)
9	USL	NumVar, NumCnst	(Such as 25)
10	Confidence level	NumCnst	Confidence level; enter a percentage, (such as 95)

## Hypertrend

Parameter	Name	Type	Description
1	Not on dialog box directly	NumCnst	Number of groups (must be > 0); reflects the number of groups you have created and the number of group parameter collections following
The following parameter numbers are relative to the start of the group (so that for the first group, parameter 2 would appear in the Connection Browser as parameter 2), and are set in the Add Group dialog box			
2	Name	TxtCnst	Group name for this set of trends
3	Trend Width	NumCnst	Trend width (in days)
4	Show Button Bar	LogCnst or NULL	Show button bar; enter yes or no
5	Paper Color	NumCnst or NULL	Paper color; enter standard Lookout color name or RGB hexadecimal value for the color you want
6	Grid color	NumCnst or NULL	Grid color; enter standard Lookout color name or RGB hexadecimal value for the color you want
7	Timeline labels	NumCnst or NULL	= No labels = Horizontal = Horizontal(small) = Vertical = Vertical (small)
8	Major increments	NumCnst or NULL	Major increments for group; enter a number (such as 10)
9	Minor increments	NumCnst or NULL	Minor increments for group; enter a number (such as 2)
10	Number of items	NumCnst	Number of items being graphed in the group; set by how many items you have configured

Parameter	Name	Type	Description
The following parameter numbers are relative to the start of the line in the group; they are set in the Add Item dialog box. The more items you chart in a group, the larger number of repetitions of these parameters you will have before the start of the next group. The first parameter of item 1 for group 1 would be numbered parameter 11.			
11	FullHeight	LogCnst	If your item is a logical value this determines whether the HyperTrend displays a full height trace. Enter yes or no.
12	URL	TxtCnst	Item URL
13	Line color	NumCnst	Set with standard Lookout color name of RGB hexadecimal value for the color you want
14	Numeric minimum or logical base position	NumCnst	Enter an integer (such as 0)
15	Numeric maximum or logical TRUE height	NumCnst	Enter an integer (such as 100)
* Each group is followed directly by all of its items, and then by the next group.			

## Integral

Parameter	Name	Type	Description
1	Input	NumVar	Signal that you want to totalize or integrate.
2	Time Unit	NumCnst	The unit time on the input signal (such as 1:00, 0:01)
3	Update	NumCnst or LogVar	The frequency at which the value of the integral is recalculated (such as 0:01, Timer1)
4	Reset	LogVar	Resets the totalizer value to zero upon transition from OFF to ON

## Interpolate

Parameter	Name	Type	Description
1	Sort order (inputs)	TxtCnst or NULL	Options string (decreasing = “d”, increasing = “a”)
2	Input Format	TxtCnst or NULL	Input format (such as “0.0E+0”, “0E0”)
3	Output Format	TxtCnst or NULL	Output format (such as “0.0E+0”, “0E0”)
4	Input(x) multiplier	NumCnst or NumVar or NULL	Input multiplier applied before interpolation
5	Output(y) multiplier	NumCnst or NumVar or NULL	Output multiplier applied after interpolation
6	Input(x)	NumCnst	First x
7	Output(y)	NumCnst	First y
8	Input(x)	NumCnst	Second x
9	Output(y)	NumCnst	Second y

## Interval

Parameter	Name	Type	Description
1	On/Off signal	LogVar, LogCnst	Signal to enable/disable timer
2	Timer delay	NumVar, NumCnst	Signal to determine delay
3	Display format	TxtCnst	Display format (such as “dd/mm/yy hh:mm:ss”, “HH:MM”); default is <NULL> parameter for MM:SS.

## Joystick

Parameter	Name	Type	Description
1	Joystick	NumCnst	Select the joystick number you want this object to control. This is a zero based count, so select 0 for joystick one, 1 for joystick two, and so on.
2	Poll	Num Cnst	Rate in milliseconds for Lookout to poll the joystick
3	Use Dead Zone	LogCnst	Enter 0 for no and 1 for yes

## Junction

Parameter	Name	Type	Description
1	Initializing Input	NumVar	Initializing input for the Junction object; enter a Lookout variable or a numeric constant
2	Additional Input 1	NumVar/NULL	One of the eight additional inputs for the Junction object
3	Additional Input 2	NumVar/NULL	One of the eight additional inputs for the Junction object
4	Additional Input 3	NumVar/NULL	One of the eight additional inputs for the Junction object
5	Additional Input 4	NumVar/NULL	One of the eight additional inputs for the Junction object
6	Additional Input 5	NumVar/NULL	One of the eight additional inputs for the Junction object
7	Additional Input 6	NumVar/NULL	One of the eight additional inputs for the Junction object
8	Additional Input 7	NumVar/NULL	One of the eight additional inputs for the Junction object
9	Additional Input 8	NumVar/NULL	One of the eight additional inputs for the Junction object



## LatchGate

Parameter	Name	Type	Description
1	Turn On	LogVar	Signal to turn the latch on
2	Turn Off	LogVar	Signal to turn the latch off

## Loader

Parameter	Name	Type	Description
1	Process Name	TxtCnst	Name to assign to loaded process (such as "process1")
2	Process File	TxtCnst	File to load (c:\lookout\process1.l4p)
3	Save state file with process file	LogCnst, NULL	Save state file with process file (save with process file = yes, save in Lookout folder = <NULL>)
4	Save state file in Lookout folder	LogCnst, NULL	Save state file as <name>.l4t in Lookout folder (save in Lookout folder = yes, save with process file =<NULL> )
5	Save Standby State File	TxtCnst, NULL	Save additional state files (such as c:\lookout\state.l4t)
6	Save period	NumCnst, NULL	Number of minutes between saves (1-1440)
7	Database computer name	TxtCnst, NULL	Computer on which the Citadel database resides (such as computer1)
8	Citadel database folder	TxtCnst, NULL	Citadel database folder (such as c:\lookout\folder)

## Maximum

Parameter	Name	Type	Description
1	Data	NumVar	Data source for the numeric screen you want to watch the maximum on
2	Reset	LogVar/NULL	Resets the maximum to zero to restart monitoring
3	Enable	LogVar/NULL	Activates the maximum object when the value of the input is TRUE

## Minimum

Parameter	Name	Type	Description
1	Data	NumVar	Signal that you are finding the minimum of
2	Reset	LogVar or NULL	Minimum value resets to zero when this value is true
3	Enable	LogVar or NULL	Minimum is active when this expression is true

## Monitor

Parameter	Name	Type	Description
1	Expression	TxtCnst or NumCnst or Var	Expression that controls output

## Mouse

The mouse object has no parameters.

## Multi-State

Parameter	Name	Type	Description
Most of these parameters are not named as such on the Multistate dialog box. The transparent pixel parameters are set in the graphics selection dialog box/			
0	condition 1(If=)	LogVar, LogCnst, NULL	Logical condition 1; enter the condition (such as Modbus1.FurnaceTemp<350)
1	graphic1	TxtCnst, NULL	Path to the graphic for the first conditional state; default path is from the lookout graphics directory (such as arrows\arrw2_dn.wmf)
2	transparent pixel x1	NumCnst, NULL	X coordinate of the pixel determining the transparent color in a bitmap (enabled only when you have chosed a .BMP graphic for the condition)
3	transparent pixel y1	NumCnst, NULL	Y coordinate of the pixel determining the transparent color in a bitmap (enabled only when you have chosed a .BMP graphic for the condition)
4	condition2 (Else if=)	LogVar, LogCnst, NULL	Logical condition 2
5	graphic2	TxtCnst, NULL	Path to the graphic for the second conditional state; default path is from the lookout graphics directory (such as arrows\arrw2_dn.wmf)
6	transparent pixel x2	NumCnst, NULL	X coordinate of the pixel determining the transparent color in a bitmap (enabled only when you have chosed a .BMP graphic for the condition)
7	transparent pixel y2	NumCnst, NULL	Y coordinate of the pixel determining the transparent color in a bitmap (enabled only when you have chosed a .BMP graphic for the condition)
8	condition3 (Else if=)	LogVar, LogCnst, NULL	Logical condition 3

Parameter	Name	Type	Description
9	graphic3	TxtCnst, NULL	Path to the graphic for the third conditional state; default path is from the lookout graphics directory (such as arrows\arrw2_dn.wmf)
10	transparent pixel x3	NumCnst, NULL	X coordinate of the pixel determining the transparent color in a bitmap (enabled only when you have chosen a .BMP graphic for the condition)
11	transparent pixel y3	NumCnst, NULL	Y coordinate of the pixel determining the transparent color in a bitmap (enabled only when you have chosen a .BMP graphic for the condition)
12	condition4 (Else if=)	LogVar, LogCnst, NULL	Logical condition 4
13	graphic4	TxtCnst, NULL	Path to the graphic for the fourth conditional state; default path is from the lookout graphics directory (such as arrows\arrw2_dn.wmf)
14	transparent pixel x4	NumCnst, NULL	X coordinate of the pixel determining the transparent color in a bitmap (enabled only when you have chosen a .BMP graphic for the condition)
15	transparent pixel y4	NumCnst, NULL	Y coordinate of the pixel determining the transparent color in a bitmap (enabled only when you have chosen a .BMP graphic for the condition)
16	condition5 (Else if=)	LogVar, LogCnst, NULL	Logical condition 5
17	graphic5	TxtCnst, NULL	Path to the graphic for the fifth conditional state; default path is from the lookout graphics directory (such as arrows\arrw2_dn.wmf)
18	transparent pixel x5	NumCnst, NULL	X coordinate of the pixel determining the transparent color in a bitmap (enabled only when you have chosen a .BMP graphic for the condition)

Parameter	Name	Type	Description
19	transparent pixel y5	NumCnst, NULL	Y coordinate of the pixel determining the transparent color in a bitmap (enabled only when you have chosed a .BMP graphic for the condition)
20	graphic6	TxtCnst, NULL	Path to the graphic for thelast (Else) conditional state; default path is from the lookout graphics directory (such as arrows\arrw2_dn.wmf)
21	transparent pixel x6	NumCnst, NULL	X coordinate of the pixel determining the transparent color in a bitmap (enabled only when you have chosed a .BMP graphic for the condition)
22	transparent pixel y6	NumCnst, NULL	Y coordinate of the pixel determining the transparent color in a bitmap (enabled only when you have chosed a .BMP graphic for the condition)

## NeutralZone

Parameter	Name	Type	Description
1	Signal	NumVar	Data stream you want to monitor
2	High Limit	NumVar	When the value of the signal exceeds this number, the NeutralZone object changes state.
3	Low Limit	NumVar	When the value of the signal falls below this number, the NeutralZone object changes state.

## Oneshot

Parameter	Name	Type	Description
1	ON/Off signal	LogVar or LogCnst	On/Off signal (such as true or Pb1)
2	Timer delay	NumVar or NumCnst	Delay/Interval (such as 0:01)
3	Display format	TxtCnst	Display format not available as an exposed parameter.

## Pager

Parameter	Name	Type	Description
1	Reserved	N/A	Reserved
2	Communication alarm priority	NumCnst	Alarm priority (1–10)
3	Retries	NumCnst	Retry attempts
4	Receive timeout	NumCnst	Receive timeout
5	Serial port	TxtCnst or NULL	Serial port (such as “COM1”)
6	Pager type	NumCnst	Pager type (Numeric only = 0, Alphanumeric = 1)
7	Delay	NumCnst or NULL	Delay in seconds
8	Terminal number		Terminal number (such as “1234567”)
9	Baud rate	NumCnst	Baud Rate (110, 300, 600, 1200, 2400, 4800, 9600)

## Panel

Parameter	Name	Type	Description
1	Title	TxtCnst, NULL	Title of the Panel window (such as “Main Control”)
2	Panel Type	NumCnst, NULL	0 = Normal 1 = Popup 2 = Popup no icon
3	Width	NumCnst	Panel width in pixels
4	Height	NumCnst	Panel height in pixels
5	XPOS	NumCnst	X-coordinate of the upper left corner of the panel (such as 0); included for compatibility, this parameter is not available through the Create Panel dialog box. It is preferable to use the x and y data members for relocating the panel rather than this parameter.
6	YPOS	NumCnst	Y-coordinate of the upper left corner of the panel (such as 0); included for compatibility, this parameter is not available through the Create Panel dialog box. It is preferable to use the x and y data members for relocating the panel rather than this parameter.

Parameter	Name	Type	Description
7	Background color	NumCnst	<p>Color of the panel background. Enter the name of the color (such as red or blue) from the following list of classic Lookout colors (use the given spelling, without quotes).</p> <p>white, ltgray, yellow, green, ltblue, blue, magenta, lime, ltviolet, pastel blue, pink, black, gray, pastelgreen, dkred, brown, dkgreen, aqua, dkblue, dkviolet, orange, ltyellow, ltgreen, blviolet, skyblue, red, hotpink, pastelviolet</p> <p>You can also use hexadecimal values to choose from the complete array of colors available with the full range of the Lookout 4.5 color selector, but mapping those values to actual colors is beyond the scope of this documentation.</p>
8	Viewing (Security levels)	NumCnst	Security level required to see the panel. Enter from the range 0–10.
9	Control (Security levels)	NumCnst	Security level required to operate controls on the panel. Enter from the range 0–10.
10	ICON	TxtCnst	Included for compatibility, this parameter is not accessible in the Create Object dialog box. It is related to the icon displayed when your lookout process is minimized and is not subsumed by the Panel Type parameter. You should leave this parameter unexposed in aggregate objects or set to "0" in a .LKS file.

## Pareto

Parameter	Name	Type	Description
1	Reset	LogVar or NULL	On transition to true, reset the object data
2	Interactive Choice	LogCnst	If true, allow operator to choose incident interactively. Enter yes or no.



Parameter	Name	Type	Description
3	Decrement Count	LogCnst	If true, allow operator to decrement the count in a bin. Enter yes or no.
4	Number of Bins	NumVar or NULL	Number of bins to display. Enter an integer
5	LastBinID	NumCnst	This parameter is not set in the Create Pareto dialog box. Last used bin ID. This reflects the number of bins you have defined. This number must match the number of sets of bin parameters you have configured.
<p><b>Pareto Bin Parameters</b>—Each bin you define has the following parameters. Each bin must have an entry for all four parameters. The total number of bins must match the number of Parameter 4, LastBinID. The second bin would start with Parameter 10 for the label of the second bin.</p>			
6	Label	TxtVar	Name of the bin.
7	Weight	NumVar	Weight assigned to the factors in this bin.
8	Color	NumCnst	<p>Color of the panel background. Enter the name of the color (such as red or blue), from the following list of classic Lookout colors (use the given spelling, without quotes).</p> <p>white, tgray, yellow , green, ltblue , blue, magenta, lime, ltviolet, pastelblue, pink, black, gray, pastelgreen, dkred, brown, dkgreen, aqua, dkblue, dkviolet, orange, ltyellow, ltgreen, blviolet, skyblue, red, hotpink, pastelviolet</p> <p>You can also use hexadecimal values to choose from the complete array of colors available with the full range of the Lookout 4.5 color selector, but mapping those values to actual colors is beyond the scope of this documentation.</p>
9	Bin ID	NumCnst	This parameter is not set in the Create Pareto dialog box. It is the Bin ID number. The last bin number should match the LastBinID parameter.

## PID

Parameter	Name	Type	Description
1	Process Variable	NumVar or NumCnst	Signal you want to control (such as Pot1)
2	Setpoint	NumVar or NumCnst	Setpoint (such as 20)
3	Min (Setpoint)	NumCnst	Minimum value of the setpoint
4	Max (Setpoint)	NumCnst	Maximum value of the setpoint
5	Automatic Enable	LogVar or LogCnst	Specifies whether the loop controller is operating in automatic mode (true) or manual mode(false) (such as Switch1, true)
6	Manual Output	NumVar or NumCnst	The output of the object when it is in manual mode (such as Pot2, 5)
7	Min (Manual Output)	NumCnst	The minimum value of the object output signal
8	Max (Manual Output)	NumCnst	The maximum value of the object output signal
9	Sample Pulse	NumCnst or LogVar	The frequency at which the PID object executes (such as 0:01)
10	Add proportional increment	LogCnst	Specifies whether the loop equation adds the proportional increment of the PID equation to the manipulated variable (MV) (such as true)
11	Gain	NumVar or NumCnst	Determines the overall sensitivity of the PID loop to changes in error (such as 0.5, 1)
12	Reset	NumVar or NumCnst	Specifies the amount of time it takes for the integral sum increment of the PID loop equation to react to a given change in error
13	Rate	NumVar or NumCnst	Dampens loop response (such as 0:30)

Parameter	Name	Type	Description
14	Freeze Enable	LogCnst	Specifies whether the loop bias should be frozen or actively back-calculated when the controller output signal goes out of range
15	Low Limit Enable	LogVar or LogCnst	Used in velocity control mode, this signal clips the PID output to a value greater than or equal to zero when TRUE.
16	High Limit Enable	LogVar or LogCnst	Used in velocity control mode, this optional logical signal clips the PID output to a value less than or equal to zero when TRUE.
17	Output Time	TxtCnst	Specifies the time domain of the controller output when operating in velocity mode (such as "0:30:00")
18	Type	NumCnst	Specifies if you are using either positional control (0) or velocity control (1); enter 0 or 1

## Pipe

Parameter	Name	Type	Description
1	"If" condition	LogVar or NULL	Expression that activates condition #1
2	Color	NumCnst or NULL	Color for gauge if first condition is met (such as 0xFFFFFFFF)
3	"Else if" condition	LogVar or NULL	Expression that activates condition #2
4	Color	NumCnst or NULL	Color for gauge if second condition is met (such as 0xFFFFFFFF)
5	"Else if" condition	LogVar or NULL	Expression that activates condition #3
6	Color	NumCnst or NULL	Color for gauge if third condition is met (such as 0xFFFFFFFF)
7	"Else if" condition	LogVar or NULL	Expression that activates condition #4

Parameter	Name	Type	Description
8	Color	NumCnst or NULL	Color for gauge if fourth condition is met (such as 0xFFFFFFFF)
9	“Else if” condition	LogVar or NULL	Expression that activates condition #5
10	Color	NumCnst or NULL	Color for gauge if fifth condition is met (such as 0xFFFFFFFF)
11	Color	NumCnst or NULL	Color if previous conditions are false (such as 0xFFFFFFFF)

## Playwave

Parameter	Name	Type	Description
1	Play when...	LogVar	Signal that enables play of the WAV file
2	Wave file	TxtCnst	Wave file to be played (such as c:\windows\chimes.wav)

## Pulse

Parameter	Name	Type	Description
1	On/Off Signal	LogVar or LogCnst	On/Off Signal (such as true)
2	Timer Period	NumCnst or LogVar	Time interval for the full pulse cycle (such as 0:01)
3	Timer Duration	NumCnst or LogVar	Width of each pulse (such as 0:00.5)
4	Display Format	TxtCnst	Not exposed for alteration.

## Pot

Parameter	Name	Type	Description
1	Minimum	NumCnst	Minimum value for the pot
2	Maximum	NumCnst	Maximum value for the pot
3	Resolution	NumCnst	Pot resolution
4	Log events	LogCnst or NULL	Log events (yes or no)
5	Control security level	NumCnst or NULL	Control security level
<b>IF Position source = DDE</b>			
6	Service	TxtCnst	Service (such as "Excel")
7	Topic	TxtCnst	Topic (such as "Sheet1")
8	Item	TxtCnst	Item (such as "R1C1")
<b>IF Position source = Remote</b>			
6	URL	LogCnst or LogVar	URL (such as \\computer\process\ objectname.datamember)

## L3Pot

Parameter	Name	Type	Description
1	Minimum	NumCnst	Minimum value for the pot
2	Maximum	NumCnst	Maximum value for the pot
3	Resolution	NumCnst	Pot resolution
4	Log events	LogCnst or NULL	Log events (yes or no)
5	Control security level	NumCnst or NULL	Control security level
<b>IF Position source = DDE</b>			
6	Service	TxtCnst	Service (such as "Excel")

Parameter	Name	Type	Description
7	Topic	TxtCnst	Topic (such as “Sheet1”)
8	Item	TxtCnst	Item (such as “R1C1”)
<b>IF Position source = Remote</b>			
6	Position	LogCnst or LogVar	Remote (such as \\computer\ process\objectname.datamember)

## Pushbutton

Parameter	Name	Type	Description
1	Button text	TxtCnst or NULL	Button text (such as “button text”)
2	Verify on	TxtCnst or TxtVar or NULL	Signal to verify on
3	Log events	LogCnst or NULL	Log events (yes or no)
4	Control security level	NumCnst or NULL	Control security level
<b>IF Position source = DDE</b>			
5	Service	TxtCnst	Service (such as “Excel”)
6	Topic	TxtCnst	Topic (such as “Sheet1”)
7	Item	TxtCnst	Item (such as “R1C1”)
<b>IF Position source = Remote</b>			
5	URL	LogCnst or LogVar	URL (such as \\computer\process\ objectname.datamember)
6	Latch output	LogCnst or NULL	Latch (yes or no)

## L3Pushbutton

Parameter	Name	Type	Description
1	Button text	TxtCnst or NULL	Button text (such as “button text”)
2	Verify on	TxtCnst or TxtVar or NULL	Signal to verify on
3	Log events	LogCnst or NULL	Log events (yes or no)
4	Control security level	NumCnst or NULL	Control security level
<b>IF Position source = DDE</b>			
5	Service	TxtCnst	Service (such as “Excel”)
6	Topic	TxtCnst	Topic (such as “Sheet1”)
7	Item	TxtCnst	Item (such as “RIC1”)
<b>IF Position source = Remote</b>			
5	Position	LogCnst or LogVar	Remote
6	Latch output	LogCnst	Latch

## Recipe

Parameter	Name	Type	Description
1	Log events?	LogCnst	Checkbox to log events. Data range is YES/NO.
2	Choose Recipe	NumCnst	Security level required to choose new recipe; data range is 0–10
3	Load Recipe file	NumCnst	Security level required to load new recipe file; data range is 0–10

## Radiobutton

Parameter	Name	Type	Description
1	Buttons	NumCnst	Number of Buttons (2–40)
2	Security level	NumCnst	Security level
3	Log events	LogCnst	Log events
4	Button labels	TxtCnst	Button labels separated by commas (such as “label1,label2,label3”)
<b>IF Position source = Remote</b>			
5	URL	LogCnst or LogVar	Remote position source

## Run

Parameter	Name	Type	Description
1	Run when	LogVar or LogCnst	The command line is executed when this signal goes true.
2	Command line	TxtCnst or TxtVar	Path to the executable to be run (such as c:\lookout\lookout.exe)
3	Start Program	NumCnst	Startup state: 0 = iconic 1 = normalized 2 = maximized
4	Alarm priority	NumCnst	Alarm priority (such as 5)

## Sample

Parameter	Name	Type	Description
1	Data	TxtVar	Signal to be sampled
2	Sample	LogVar or NULL	Determines when to sample
3	Enable	LogVar or NULL	Enables or disables sampling



## Sampletext

Parameter	Name	Type	Description
1	Data	TxtVar	Signal to sample
2	Sample	LogVar, NULL	Signal to trigger sampling
3	Enable	LogVar, NULL	Signal that enables sampling

## Scale

Parameter	Name	Type	Description
1	Minimum	NumVar	Scale minimum
2	Maximum	NumVar	Scale maximum
3	Major unit	NumVar or NULL	Interval between major (labeled) ticks
4	Minor unit	NumVar or NULL	Interval between minor (labeled) ticks
5	Absolute Minimum	NumCnst or NULL	Absolute minimum (min can't go below this)
6	Absolute Maximum	NumCnst or NULL	Absolute maximum (max can't go above this)

## Sequencer

Parameter	Name	Type	Description
1	States	NumCnst	Number of states in the sequence
The following parameters repeat in sequence for each state in the sequencer. For example, State2 would begin with Parameter 5.			
2	State No. (1–100)	TxtCnst or NULL	Label for the state (such as “State1”)

Parameter	Name	Type	Description
3	Time Limit (1–100)	NumCnst or NumVar or NULL	Time period for the state (such as 0:10)
4	Outputs (1–100)	NumCnst or NULL	Output for the sequence selection. This is a hexadecimal number used to represent which of the 26 outputs is turned on, with 0x000001 representing the single output A as being on, and 0xFFFFFFFF representing all the outputs A–Z being turned on.

## Spinner

Parameter	Name	Type	Description
1	Spin	LogCnst or LogVar	Signal to enable spinning
2	Speed when spinning	NumCnst	Speed when spinning
<b>If the type of the spinner is “Numeric”</b>			
3	Signal value at 0% speed	NumCnst	Signal value at 0% speed
4	Signal value at 100% speed	NumCnst	Signal value at 100% speed

## Spreadsheet

Parameter	Name	Type	Description
1	Name	TxtCnst, TxtVar	File name (such as “sheet1”, sheet17.dat”, etc.)
2	Type	TxtCnst	File type (“csv”)
3	Directory tree location	TxtCnst	File directory location (“perpetual”, “yearly”, “monthly”, or “daily”)

Parameter	Name	Type	Description
4	Interval logging, interval	NumCnst, NumVar, NULL	File logging rate (variable from 000 (don't log) to years – such as 30:00 for 30 minutes)
5	Interval logging, logging	LogVar, LogCnst, NULL	If TRUE, log new row at LOGRATE interval, otherwise ignore interval
6	Log now	LogVar, NULL	Signal enables: Log now!! – overrides interval and logging
7	Log on every data change	LogCnst	Log if there is change in the signal value (yes, no)
8	First data field	Log, Num, Txt, Cnst, Var	First data field expression
9	Format	Text	Cell format (such as “General”, “0.0”, “dd/mm/yy hh:mm:ss”)

## Sort

Parameter	Name	Type	Description
1	Sort Order	LogCnst or LogVar	sets sort order to Ascending or Descending true = ascending false = descending

## SQL Exec

Parameter	Name	Type	Description
1	Data Source	TxtVar	(Such as “DSN=Excel Files; DBQ=C:\pathname;”)
2	SQL	TxtVar	(Such as “Select Priority”)
3	Alarm priority	NumCnst	Enter an integer
4	Buffer SQL	LogCnst	Enter yes or no

## Switch

Parameter	Name	Type	Description
1	On	TxtCnst/txtvaror NULL	Action on verification message
2	Off	TxtCnst/txtvaror NULL	Action off verification message
3	Log events	LogCnst or NULL	Log events
4	Control security level	NumCnst or NULL	Control security level
<b>IF Position source = DDE</b>			
5	Service	TxtCnst	Service (such as “Excel”)
6	Topic	TxtCnst	Topic (such as “Sheet1”)
7	Item	TxtCnst	Item (such as “r1c1”)
<b>IF Position source = Remote</b>			
5	URL	LogCnst or LogVar	URL (such as \\computername\processname\ objectname.datamember)

## L3Switch

Parameter	Name	Type	Description
1	On	txtcnstor txtvaror NULL	Action on verification message
2	Off	txtcnstor txtvaror NULL	Action off verification message
3	Log events	LogCnst or NULL	Log events
4	Control security level	NumCnst or NULL	Control security level
<b>IF Position source = DDE</b>			

Parameter	Name	Type	Description
5	Service	TxtCnst	Service (such as “Excel”)
6	Topic	TxtCnst	Topic (such as “Sheet1”)
7	Item	TxtCnst	Item (such as “r1c1”)
<b>IF Position source = Remote</b>			
5	Position	LogCnst or LogVar	Remote (such as Switch1.enable)

## Textentry

Parameter	Name	Type	Description
1	Entry prompt	TxtCnst or NULL	Entry prompt
2	Reserved	N/A	Reserved
3	Log events	LogCnst or NULL	Log events (yes or no)
4	Control security level	NumCnst or NULL	Control security level
<b>IF Position source = DDE</b>			
5	Service	TxtCnst	Service (such as “Excel”)
6	Topic	TxtCnst	Topic (such as “Sheet1”)
7	Item	TxtCnst	Item (such as “r1c1”)
<b>IF Position source = Remote</b>			
5	URL	LogCnst or LogVar	URL such as \\computername\processname\ objectname.datamember)

## L3TextEntry

Parameter	Name	Type	Description
1	Entry prompt	TxtCnst or NULL	Entry prompt
2	Reserved	N/A	Reserved
3	Log events	LogCnst or NULL	Log events (yes or no)
4	Control security level	NumCnst or NULL	Control security level
<b>IF Position source = DDE</b>			
5	Service	TxtCnst	Service (such as “Excel”)
6	Topic	TxtCnst	Topic (such as “Sheet1”)
7	Item	TxtCnst	Item (such as “r1c1”)
<b>IF Position source = Remote</b>			
5	Position	LogCnst or LogVar	Position (such as <code>objectname.enable</code> )

## TIMEOFxxxx

Parameter	Name	Type	Description
1	On\Off Signal	LogVar or LogCnst	On/off signal
2	Timer offset	NumCnst or LogVar	Offset/period (such as 14:00:00)
3	Timer duration	NumCnst or LogVar	Delay/Interval (such as 0:05)
4	Format	TxtCnst	Not available as an exposed parameter

## Trend

Parameter	Name	Type	Description
1	Trend width	NumCnst	Time width of the trend display; enter a Lookout time (such as 0:30)
2	Sample interval	NumCnst	Time interval for sampling the values being displayed; enter a Lookout time (such as 0:00.1)
The following parameters are repeated in sets of 4, one set for each trace you add to the trend object			
3	Line <i>N</i> expression	NumVar or LogVar	This is the Lookout data you want to trace. Enter the Lookout expression, such as <code>Waveform1.random</code>
4	Minimum	NumCnst	Trace display minimum; enter a number (such as 0)
5	Maximum	NumCnst	Trace display maximum; enter a number (such as 100)
6	Line color	NumCnst	Line color for the trace; enter standard Lookout color name or the RGB hexadecimal value for the color you want

## XBarR

Parameter	Name	Type	Description
1	Observed signal	NumVar	Signal to watch
2	Observed trigger	LogVar	Trigger an observation
3	Reset	LogVar or NULL	Clear all of the collected and calculated values
4	Number of samples to display	NumVar or NumCnst	Number of samples to display
5	Number of observations/sample	NumVar or NumCnst	Number of observations per sample

Parameter	Name	Type	Description
6	X-bar chart UCL	NumCnst or NumVar or NULL	X-bar chart UCL
7	X-bar chart LCL	NumCnst or NumVar or NULL	X-bar chart LCL
8	X-bar chart CL	NumCnst or NumVar or NULL	X-bar chart CL
9	R chart UCL	NumCnst or NumVar or NULL	R chart UCL
10	R chart LCL	NumCnst or NumVar or NULL	R chart LCL
11	R chart CL	NumCnst or NumVar or NULL	R chart CL

## Xchart

Parameter	Name	Type	Description
1	Observed signal	NumVar	Signal to watch
2	Observed trigger	LogVar	Trigger an observation
3	Reset	LogVar, NULL	Clear all of the collected and calculated values
4	Number of samples to display	NumVar, NumCnst	Number of samples to display
5	Number of observations/sample	NumVar, NumCnst	Number of observations/sample (NOT SET IN DIALOG BOX)
6	X Chart Control Limits UCL	NumVar, NumCnst, NULL	X-bar chart UCL



Parameter	Name	Type	Description
7	X Chart Control Limits LCL	NumVar, NumCnst, NULL	X-bar chart LCL
8	X Chart Control Limits CL	NumVar, NumCnst, NULL	X-bar chart CL
9	R_UCL	NumVar, NumCnst, NULL	R chart UCL (NOT SET IN DIALOG BOX)
10	R_LCL	NumVar, NumCnst, NULL	R chart LCL (NOT SET IN DIALOG BOX)
11	R_CL	NumVar, NumCnst, NULL	R chart CL (NOT SET IN DIALOG BOX)

## XYChart

Parameter	Name	Type	Description
1	X	NumVar	X signal to chart (such as Pot1)
2	Ysignal	NumVar	Y signal to cahrt (such as Pot2)
3	Trigger	LogVar	Input to trigger a sample (such as Pb1)
4	Min X	NumVar	Minimum value of X on chart; enter an integer
5	Max X	NumVar	Maximum value of X on chart; enter an integer
6	Min Y	NumVar	Minimum value of Y on chart; enter an integer
7	Max Y	NumVar	Maximum value of Y on chart; enter an integer
8	Number of points to display	NumVar	Number of points to display (such as 50)
9	Reset	LogVar or NULL	Clear all of the collected values (such as Pb2)

---

## Technical Support Resources

### Web Support

---

National Instruments Web support is your first stop for help in solving installation, configuration, and application problems and questions. Online problem-solving and diagnostic resources include frequently asked questions, knowledge bases, product-specific troubleshooting wizards, manuals, drivers, software updates, and more. Web support is available through the Technical Support section of [ni.com](http://ni.com)

### NI Developer Zone

---

The NI Developer Zone at [ni.com/zone](http://ni.com/zone) is the essential resource for building measurement and automation systems. At the NI Developer Zone, you can easily access the latest example programs, system configurators, tutorials, technical news, as well as a community of developers ready to share their own techniques.

### Customer Education

---

National Instruments provides a number of alternatives to satisfy your training needs, from self-paced tutorials, videos, and interactive CDs to instructor-led hands-on courses at locations around the world. Visit the Customer Education section of [ni.com](http://ni.com) for online course schedules, syllabi, training centers, and class registration.

### System Integration

---

If you have time constraints, limited in-house technical resources, or other dilemmas, you may prefer to employ consulting or system integration services. You can rely on the expertise available through our worldwide network of Alliance Program members. To find out more about our Alliance system integration solutions, visit the System Integration section of [ni.com](http://ni.com)

## Worldwide Support

---

National Instruments has offices located around the world to help address your support needs. You can access our branch office Web sites from the Worldwide Offices section of [ni.com](http://ni.com). Branch office Web sites provide up-to-date contact information, support phone numbers, e-mail addresses, and current events.

If you have searched the technical support resources on our Web site and still cannot find the answers you need, contact your local office or National Instruments corporate. Phone numbers for our worldwide offices are listed at the front of this manual.

# Glossary

---

Prefix	Meanings	Value
μ-	micro-	10 <sup>-6</sup>
m-	milli-	10 <sup>-3</sup>
k-	kilo-	10 <sup>3</sup>
M-	mega-	10 <sup>6</sup>

## A

absolute date  
absolute time

Numeric system Lookout uses for keeping track of dates and times, in which midnight (0 hours), January 1, 1900 is represented by 1, midnight of January 2, 1900 is represented by 2, and so on. The absolute date/time number 36234.47222250 represents 11:20 AM, March 15, 1999.

The numeric value for 1 second in Lookout is .000011574, the numeric value for 1 minute is .000694444, and the numeric value for 1 hour is .041666667.

ACK

Acknowledge (an alarm or event).

active notification

A feature of event-driven software systems in which the application is alerted of value changes when they occur instead of through continuous, loop-driven queries.

address space

An OPC term for the area you browse to find what items are available on an OPC server. Part of the standard OPC interface, this space may arrange items hierarchically.

alarm

Software notification of a condition in a process. This alarm may call attention of a value that has exceeded or fallen below certain levels, set in the object database or in an Alarm object.

alias

Name given to a data member using the **Edit Database** dialog box. This name can be descriptive or mnemonic, and may be associated with other data member configurations such as scaling, logging, and alarming. A data member can have more than one alias, each with different associated configurations.

## B

- baud rate Measurement of data transmission speed, formally defined as the number of electronic state changes per second. Because most modems transmit four bits of data per change of state, is sometimes misused or misunderstood—a 300 baud modem is moving 1200 bits per second. *See* [BPS](#).
- .bmp files Graphic files in bitmap format. If you are using a .bmp file in Lookout, you cannot resize it on screen. *See* [Windows metafile](#).
- BPS Bits per second—measure of the rate of transfer of data.

## C

- CBL compiler Lookout uses the CBL (Control Block Language) compiler to compile a Lookout source file (.lks) into a binary file (.l4p).
- .cbx file A Lookout file containing a Lookout object class. A .cbx (Control Block Extension) file may have one or more object classes in it.
- checksum A method of verifying that the number of bits received is the same as the number of bits transmitted. Used by TCP/IP and serial protocols.
- Citadel The Lookout historical database that stores your data for access later.
- classes *See* [object classes](#).
- client A Lookout process that monitors a Lookout server process. Lookout clients should be computer independent so that they can be run from any computer on your network. Lookout server processes run on computers actually connected to your control hardware.
- comm port Term sometimes used for a serial port.
- connection Input to a Lookout object's writable data members. For more information, refer to Chapter 4, *Using Lookout* in the *Getting Started with Lookout* manual.
- control objects Lookout objects you use to control a process, change a data value, adjust a register, and so on.
- controllable objects Lookout objects you can control with a Lookout control object.

.csv files	Comma Separated Value file, a format widely accepted by spreadsheet and other data handling programs.
CTS	Clear to Send. Part of a handshaking protocol for certain devices that connect the serial port of a computer. Refer to the <i>RTS/CTS Handshaking Settings</i> section of Chapter 3, <i>Serial Port Communication Service</i> , in the <i>Lookout Developer's Manual</i> for detailed information.
cursor (DataTable)	The Lookout data table can activate one row of data at a time using the data table cursor. Refer to the data table reference in the Lookout online help or the <code>Cursor</code> object section.

## D

DAQ	Short for Data AcQuisition.
data member	Data source or sink associated with a Lookout object. A readable data member, or source, may be used in expressions or as inputs to other objects. A writable data member, or sink, may have at most one connection into it, created using the <b>Object»Edit Connections</b> dialog box. A data member may be both readable and writable. <i>See also</i> <a href="#">native data member</a> and <a href="#">alias</a> .
data type	Kind of value (numeric, logical, or text) that a parameter or data member can hold.
database	Collection of data stored for later retrieval, display, or analysis.
datagram	Message sent between objects in Lookout. A datagram contains a route and a value.
DCOM/COM	Distributed Component Object Model, a Microsoft standard in which client program objects request services from server program objects.  The Component Object Model (COM) is a set of interfaces, clients, and servers used to communicate within the same computer (running Windows 98/95 or Windows NT).
DDE	Dynamic Data Exchange, currently used in Lookout to exchange data with other programs (such as Microsoft Excel) running on your network.

deadband	A value that must be exceeded for an alarm to sound or a change in state to be recorded. For instance, if you have a low-level alarm set at 5 with a deadband of 2, the alarm will not trigger until the value being monitored drops to 5. The alarm will then stay active until the value being monitored moves above 7. A deadband keeps small oscillations of value from triggering an alarm and then canceling it too rapidly.
deviation	Set a deviation to filter out small changes in value when logging data. Before being logged to a database, a value must change by at least the deviation amount of the last logged value.
dialing prefix	Part of the Hayes AT command set for use with modems. See the Dial-Up Modem Settings section of Chapter 3, <i>Serial Port Communication Service</i> , in the <i>Lookout Developer's Manual</i> for detailed information.
displayable objects	A Lookout object class that has a displayable component, such as a Pot, a Switch, or a Pushbutton.
DLL	A Dynamic Link Library, which is a collection of small, special purpose programs which can be called by a larger program running on the computer. Sometimes called Dynamically Linked Library.
driver objects	Lookout objects used to communicate with PLCs, RTUs, and other I/O devices.

## E

edit mode	Lookout mode in which you can alter and create objects within a process. Switch in and out of edit mode by pressing <Ctrl-space> or by selecting <b>Edit»Edit Mode</b> .
engineering unit	In Lookout, used to refer to scaled or converted data. Thermocouple data, for instance, arrives in volts as the raw unit, and must be converted to degrees, an engineering unit.
environment services	Tasks Lookout performs as a part of making your SCADA/HMI work easier. Lookout environment services include serial communications, database and logging, security, networking, alarming, and so on.
Ethernet	A widely used, standardized local area networking technology, specified in the IEEE 802.3 standard.

event	Anything that happens can be an event. In Lookout, events include such things as adjusting a control value, entering or exiting edit mode, opening or closing a control panel, and logging in or logging out of the system.
expression functions	Mathematical, logical, and other functions used by Lookout expressions.
expressions	Lookout expressions are often paths to a data member. They can also function like variables that, using a spreadsheet cell type formula, become capable of performing flexible, real-time math operations, condition testing, and other complex operations functions. See Chapter 1, <i>Expressions</i> , in the <i>Lookout Developer's Manual</i> for more information on expressions.

## F

failover	A failover is the takeover of a process by a standby computer when the primary computer fails for any reason.
FieldBus	An all digital communication network used to connect process instrumentation and control systems.
FieldPoint	A National Instruments hardware product line for industrial automation, control, monitoring, and reporting.
frame	Sequence of bytes sent from a computer to a device or vice versa. The syntax of the frame depends on the protocol being used. A read frame contains enough information to specify a set of variables whose values the device should return. A write frame specifies a variable in the device and a new value to write into that variable. Some protocols support the writing of multiple variables in a single frame. A response frame is returned from the device to the computer, indicating whether the frame just sent to it was received successfully. If the frame just received was a read frame, the response frame contains a set of requested values.
functionality	The way an object works, operates, or performs a task. Functionality is a general concept that applies in the same way to all objects in a given object class. Parameters define the specific functionality of an individual object.
functions	See <a href="#">expression functions</a> .



## G

**gray proximity** A term used in Lookout color animation. This sets what percentage of gray will be replaced by a given color as conditions change in a monitored value or set of values.

## H

**Hi and HiHi** Alarm settings. Both warn that a value has gone above some setpoint. Generally a Hi alarm is used to alert an operator of a need for intervention. A hihi alarm is usually used to alert an operator that the value has been exceeded by an even greater margin than a hi alarm indicates, and is usually used to indicate an urgent need for action.

**historical logging** The process of storing data in a database for use at another time, or from another location.

**HOA** Hand-Off-Auto control, used to set whether a value must be changed manually, is completely turned off, or functions automatically. You can use a Pot object and a complex expression to create this sort of control in Lookout, or you can use a RadioButton object, depending on the particular requirements of the task you need to accomplish.

## I

**I/O point** Every read-only, write-only, or read-write connection Lookout makes to external hardware is counted as an I/O point. Lookout is licensed for use with a set number of I/O points. If you exceed the number you are licensed to use with your copy of Lookout, a warning message appears on your computer screen warning you to shut down one of your processes within a specified time before Lookout cuts back on I/O usage.

**(implicit) data member** A Lookout data member containing the fundamental data for certain object classes. When you make a connection to an (implicit) data member, you only use the name of the object, not the name of the object followed by the data member name.

**L**

.l4p files	File extension for Lookout process files. These are the compiled files Lookout runs when it runs a process.
.l4t files	File extension for a Lookout state file, which stores the values for Lookout controls and other objects with state information.
.lka files	File extension for Lookout security files.
.lkp files	File extension for Lookout process files in versions of Lookout earlier than Lookout 4.
.lks files	File extension for a Lookout source file, which Lookout compiles to make a Lookout process file that Lookout can run. This is the file you should make sure you keep backed up in case you need to recreate a corrupted process file, or in case some future version of Lookout cannot run a process file compiled in an earlier version of Lookout.
logging	The process of storing data in a computer database file. See Chapter 7, <i>Logging Data and Events</i> , in the <i>Lookout Developer's Manual</i> for more information on logging data in Lookout.
logical data member	A Lookout data member of the logical data type.
.lst files	Extension for the Lookout state file in versions of Lookout earlier than Lookout 4.

**M**

multiplex	A method of working with more than one data stream using only one communications channel. There are a number of different methods of multiplexing, depending on the hardware and software being used. A number of Lookout driver objects support multiplexing hardware.
-----------	---

## N

- native data member      Data members built into a Lookout object class, as opposed to data members you create by using aliases.
- NetDDE      A way of networking using DDE (dynamic data exchange), retained in Lookout 4 and later for compatibility with earlier versions of Lookout.
- numeric data member      A Lookout data member of the numeric data type.

## O

- object      A specific instance created from an object class.
- object classes      Software modules you use to create individual objects to perform tasks in Lookout.
- object connections      Software links between objects used to transmit data and commands from one object to another.
- ODBC      Open DataBase Connectivity, a standard application programming interface (API) for accessing a database. You can use ODBC statements to access files in a number of different databases, including Access, dBase, DB2, and Excel.
- ODBC is compatible with the Structured Query Language (SQL) Call-Level Interface. ODBC handles SQL requests by converting them into requests an ODBC database can use.
- OPC      OLE for Process Control, an industry standard interface providing interoperability between disparate field devices, automation/control systems, and business systems. Based on ActiveX, OLE, Component Object Model (COM), and Distributed COM (DCOM) technologies.

## P

- parameter      Input to an object, similar to a writable data member, whose value is specified in the object parameter list in a Lookout source (.lks) file. Typically, parameter values are set in the object **Object»Create** or **Object»Modify** dialog box.

ping	A small utility program in Windows and DOS that checks to see if a computer can be reached across a network. Also used to indicate the running of that program.
pixel	Picture Element, the smallest bit of a picture. Has one color or shade of grey. The number of pixels per inch determine the resolution of an image.
PLC	Programmable Logic Controller.
poll	A software event in which a computer checks some value in a device or register. In Lookout, a logical command that forces a device poll to check data member values.
poll rate	How often a device is polled.
pop-up panel	One variety of Lookout control panel that can only be displayed at the size set by the process developer, and which cannot be maximized. When open, a popup panel remains on top of other panels until minimized.
process	In Lookout, process refers to a Lookout “program,” used for industrial automation, control, monitoring, or reporting.
process file	The Lookout binary file Lookout executes when running a process. Carries the .14p extension.

## R

raw unit	Data as it arrives in your process, such as voltage or amperage. Thermocouple data, for instance, arrives in volts as the raw unit, and must be converted to degrees, an engineering unit.
receive gap	A serial communications setting that determines the number of empty bytes (or amount of time) a driver receives before recognizing the end of a message frame and requesting another message. See the <i>Setting Receive Gap</i> section of Chapter 3, <i>Serial Port Communication Services</i> , in the <i>Lookout Developer's Manual</i> for more information about the receive gap.
redundancy	A system for making sure that a computer can come online and run a Lookout process if the computer currently running that process fails for some reason.

remote	In the context of Lookout, remote is a position source location for a control. See the <i>Remote Position Source Connections</i> section of Chapter 4, <i>Using Lookout</i> , in the <i>Getting Started with Lookout</i> manual for detailed information on the Lookout remote position source.
resolution	The smallest signal increment that can be detected by a measurement system. Also, the number of pixels per inch on a computer monitor screen or dots per inch in printer output.
RTS	Request to Send, part of a handshaking protocol for certain devices that connect the serial port of a computer. See the <i>RTS/CTS Handshaking Settings</i> section of Chapter 3, <i>Serial Port Communication Service</i> , in the <i>Lookout Developer's Manual</i> for detailed information.
RTU	Remote Terminal Unit, a device similar to a PLC for use at a remote location, communicating with a host system through radio or telephonic connections.
run mode	Lookout mode in which processes run but no editing changes can be made. Switch in and out of run mode by pressing <Ctrl-space> or selecting <b>Edit»Edit Mode</b> .

## S

SCXI	Signal Conditioning eXtensions for Instrumentation, a National Instruments product line for conditioning low-level signals.
security accounts	Also called user and group accounts, Lookout uses security accounts to define what users or group of users have different operation privileges in Lookout. See Chapter 6, <i>Security</i> , in the <i>Lookout Developer's Manual</i> for detailed information on Lookout security.
server	A process that provides data (services) to client processes. In Lookout, server processes are intended to be run on one computer only, with direct connections to field hardware. Client processes interact with field hardware through server processes.
source file	Lookout file that can be compiled to produce a binary Lookout process file that runs a process. Uses a <code>.lks</code> file extension.
SQL	Structured Query Language, used to get information from and update information in a database.

standby	A computer standing by to take over running a process if the primary computer fails or falls offline.
startup file	A Lookout process file (.14p) you designate in the <b>System Options</b> dialog box that Lookout will open and run any time Lookout is opened.
state file	The Lookout file that stores the value of all Lookout control parameters and object data members in use in a process. Uses the file extension .14t.
system objects	Lookout objects used to control other objects or process and analyze data.

## T

TCP TCP/IP	Transmission Control Protocol, a method (protocol) for sending data between computers. Used with IP, the Internet Protocol.  TCP/IP sends data as packets, with IP handling the delivery of data and TCP keeping track of the individual packets.
text data member	Lookout data member used for text data.
trace	A term for data from a single source over some period of time, stored in an ODBC-compliant database.
traces table	ODBC databases present data in the form of traces tables. A traces table contains a field or column of data for each data member being logged, along with a field you can use to query the database.
trend	Historical data showing the change in a value over time. Often used in connection with graphing the data for display.

## W

.wav files	File extension given to sound files. You can play a .wav file in Lookout to add sounds or speech to alarms or events.
Windows metafile	A standard graphics file type for use in the Microsoft Windows operating environment. If you use a metafile graphic in Lookout, you can enlarge or reduce it on the screen, use them as masks without specifying transparent pixels, and use the Lookout Animator to animate the colors of the graphic.
.wmf file	File extension given to Windows Metafile graphic files.

## **X**

`.xls` file

File extension given to Microsoft Excel files.