

## COMPREHENSIVE SERVICES

We offer competitive repair and calibration services, as well as easily accessible documentation and free downloadable resources.

## SELL YOUR SURPLUS

We buy new, used, decommissioned, and surplus parts from every NI series. We work out the best solution to suit your individual needs.

 Sell For Cash    Get Credit    Receive a Trade-In Deal

## OBSOLETE NI HARDWARE IN STOCK & READY TO SHIP

We stock **New**, **New Surplus**, **Refurbished**, and **Reconditioned** NI Hardware.



*Bridging the gap between the manufacturer and your legacy test system.*

 1-800-915-6216

 [www.apexwaves.com](http://www.apexwaves.com)

 [sales@apexwaves.com](mailto:sales@apexwaves.com)

*All trademarks, brands, and brand names are the property of their respective owners.*

**Request a Quote**

 **CLICK HERE**

**SH68-C68-S**

## GETTING STARTED

# NI SMD-7610 Stepper Drives and NI 73xx Motion Controllers

This document explains how to install and configure the NI SMD-7610 stepper drives for use with the NI 7330/7340/7350 motion controllers.



**Tip** If you encounter any problems during setup, refer to the [Worldwide Support and Services](#) section for assistance.

## Contents

---

What You Need to Get Started .....	2
Hardware .....	2
Software.....	2
Hardware Configuration and Installation .....	3
Step 1: Install NI-Motion.....	3
Step 2: Install the NI 73xx Motion Controller.....	4
Step 3: Install Software on and Configure the RT PXI Controller (PXI Motion Controllers Only).....	5
Step 4: Connect and Configure the NI UMI-7764 .....	7
Step 5: Connect the Drive Command Signals to the UMI-7764 .....	8
Step 6: Connect the Drive Enable Signal to the UMI-7764 .....	10
Step 7: (Optional) Connect the Drive Fault Signal to the UMI-7764 .....	10
Step 8: (Optional) Connect the Encoder Signals to the UMI-7764.....	10
Step 9: Connect the NI PS-12/13 Power Supply to the NI SMD-7610 .....	11
Step 10: Connect the SMD-7610 to the Motor.....	12
Step 11: Configure the NI SMD-7610 DIP Switches.....	13
Step 12: Power on the Drive and Verify Connections.....	16
Software Installation and Configuration.....	16
Step 1: Update Firmware on the Motion Controller.....	16
Step 2: Configure the NI Motion Controller .....	17
Step 3: Test the Motor In MAX.....	18
Where to Go Next.....	19
Worldwide Support and Services .....	20

# What You Need to Get Started

---

You need the following items to get started.



**Note** You cannot connect the NI SMD-7610 to NI 73xx motion controllers using the NI UMI-7772/7774.

## Hardware

- A computer with an available PXI or PCI slot
- NI 7330, NI 7340, or NI 7350 motion controller
- UMI-7764
- SH68-C68-S cable to connect your NI UMI and motion controller
- +5 V power supply for the UMI-7764
- Snap-on ferrite bead for the power supply cable (included with your NI UMI-7764). Refer to the *UMI-7764 User Guide and Specifications* for installation information.
- NI SMD-7610 stepper drive
- NI PS-12 or NI PS-13 power supply for the NI SMD-7610
- NI or third-party stepper motor



**Note** NI offers stepper motors matched to the NI SMD-7610. Refer to [ni.com/motion](http://ni.com/motion) for motor options. National Instruments highly recommends using these motors for the best user experience.

- (optional) ENC-7740 encoder for ST17 motors (NI part number 748991-01) or ENC-7741 encoder for ST23 motors (NI part number 748992-01)
- NI-7748 encoder cable to connect the encoder to the UMI-7764 (NI part number 748994-01)

## Software

- NI-Motion 7.6 or later driver software



**Tip** Refer to KB 4WRDJ3WA, *Which LabVIEW Version Supports NI-Motion?*, at [ni.com/kb](http://ni.com/kb), for NI-Motion/LabVIEW version compatibility information.

- One of the following software packages and documentation:
  - LabVIEW 8.5 or later
  - LabWindows™/CVI™ 8.5 or later
  - Microsoft Visual C++ 6.0
  - Microsoft Visual Basic 6.0

Figure 1 shows the hardware connections using a UMI-7764.

**Figure 1.** UMI-7764 to NI SMD-7610 Drive Connections

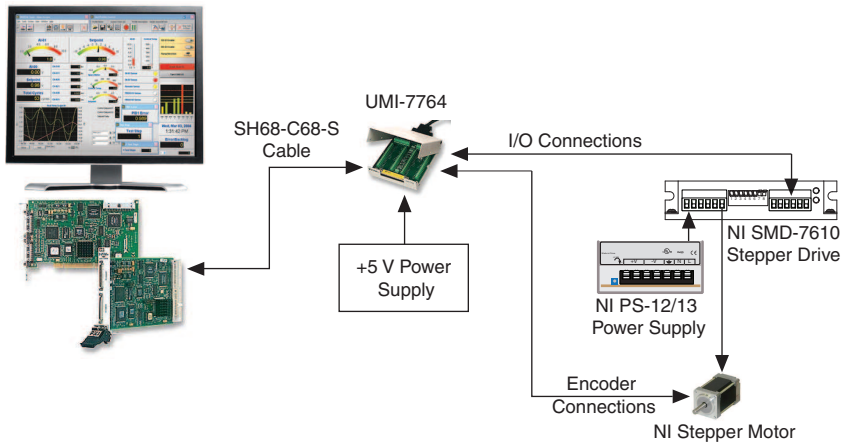

## Hardware Configuration and Installation

This section covers the hardware setup for the NI motion controller, NI UMI-7764, and NI SMD-7610 stepper drive.



**Caution** Before installing the NI 7330/7340/7350 motion controller refer to the user manual appropriate to your controller for safety and specification information. Failure to follow safety instructions may result in damage to equipment.

### Step 1: Install NI-Motion

You must install the NI-Motion driver software *before* installing an NI motion controller for the first time. If you are upgrading from a previous version of NI-Motion, it is not necessary to remove the NI motion controller before installing the upgrade. The upgrade does not affect the existing Microsoft Windows configuration.



**Note** If you are using a Real-Time OS, install LabVIEW Real-Time on the development computer before installing NI-Motion so that the RT support files install.

Complete the following steps to install the NI-Motion driver software:



**Note** When installing NI-Motion, you must be logged on with administrator-level access. After you have restarted the system, you may need to refresh Measurement & Automation Explorer (MAX) to view the new controller.

1. Insert the NI-Motion CD into the CD-ROM drive to display the NI-Motion installation screen, or download the latest version from [ni.com/downloads](http://ni.com/downloads).
2. If you have autorun enabled, `autorun.exe` runs automatically. Otherwise, double-click `autorun.exe`.
3. Follow the onscreen instructions.



**Note** You must update the firmware on your NI motion controller(s) before you can use them with the corresponding version of NI-Motion. Refer to [Step 1: Update Firmware on the Motion Controller](#) in the [Software Installation and Configuration](#) section for detailed instructions.

## Step 2: Install the NI 73xx Motion Controller

The following sections explain how to install PXI and PCI motion controllers.

### PXI Controllers

1. Power off and unplug the chassis.



**Caution** To protect yourself and the computer from electrical hazards, the computer *must* remain unplugged until the installation is complete.

2. Choose an unused peripheral slot and remove the filler panel.
3. Touch a metal part on the chassis to discharge any static electricity that might be on your clothes or body. Static electricity can damage the controller.
4. Insert the PXI controller into the chosen slot. Use the injector/ejector handle to fully secure the device into place.
5. Attach the front panel of the PXI controller to the front panel mounting rails of the chassis with the slot screws on the chassis.



**Caution** Always power on the computer containing the motion controller and initialize the controller before you power on the rest of the motion system. Power off the motion system in the reverse order.

6. Plug in and power on the chassis.

### PCI Controllers

1. Power off and unplug the computer.



**Caution** To protect yourself and the computer from electrical hazards, the computer *must* remain unplugged until the installation is complete.

2. Open the computer case to expose access to the PCI expansion slots.
3. Touch a metal part on the chassis to discharge any static electricity that might be on your clothes or body. Static electricity can damage the controller.

4. Choose an unused +3.3 V or +5 V PCI slot, and remove the corresponding expansion slot cover on the back panel of the computer.
5. Gently rock the controller into the slot. The connection may be tight, but do *not* force the controller into place.



**Note** Check that the bracket of the device aligns with the hole in the back panel rail of the computer chassis.

6. Secure the mounting bracket of the controller to the back panel rail of the computer.
7. Replace the cover.



**Caution** Always power on the computer containing the motion controller, and then initialize the controller before you power on the rest of the motion system. Power off the motion system in the reverse order.

8. Plug in and power on the computer.

## Step 3: Install Software on and Configure the RT PXI Controller (PXI Motion Controllers Only)



**Note** This step is only required if you are using a PXI-7330/7340/7350 motion controller and an RT PXI controller. If you are not using an RT PXI controller, skip to the [Step 4: Connect and Configure the NI UMI-7764](#) section.

Complete the following steps to configure the controller and install software on it.



**Note** The Measurement & Automation Explorer (MAX) user interface may not match these steps exactly depending on which version of MAX you are using.

1. Boot the NI PXI embedded controller into the real-time operating system. The PXI controller automatically boots into LabVIEW RT Safe Mode when no software is installed. LabVIEW RT Safe Mode loads with the basic real-time operating system and automatically attempts to connect to the network using DHCP. If DHCP is not available, the controller connects to the network with a link-local IP address.



**Tip** You can connect a monitor to the PXI to display startup messages such as the IP address and MAC address.

2. Launch Measurement & Automation Explorer (MAX) on the development computer by clicking the MAX icon on the desktop () , or by selecting **Start»All Programs»National Instruments»Measurement & Automation**.
3. Expand the **Remote Systems** branch. MAX lists the PXI controller as the model name of the controller followed by the MAC address (for example, **NI-PXI-8104 00802f108562**).



**Tip** Record the PXI controller MAC address, located on the side of the controller, for use in identifying the controller. The label also can be removed and placed on the front of the controller for easier access. If you have connected the PXI controller to a monitor, the MAC address also appears when the PXI system boots up.

4. Select the **System Settings** tab and type a descriptive name for the system in the **Name** field.
5. (Optional) Complete this step only if the target has an empty IP address (0.0.0.0). Select the **Network Settings** tab and select **DHCP or Link Local** from the **Configure IPv4 Address** list to assign an IP address or select **Static** to specify a static IP address in the **IPv4 Address** section.
6. Click **Save** on the toolbar and let MAX reboot the system.
7. When the new system name appears under **Remote Systems**, expand the controller item in the tree, right-click **Software**, and select **Add/Remove Software**.
8. Install the LabVIEW Real-Time software and NI-Motion on the RT target. Go to [ni.com/info](http://ni.com/info) and enter `etspc` for the latest information about supported software.
9. Click **Next** to install the selected software on the controller. Click **Help** if you need information about installing recommended software sets.
10. Wait for installation to complete, then click **Finish**.
11. Expand the **Devices and Interfaces** item under the PXI system.
12. Right-click the remote motion controller icon and select **Map to Local Machine**. This assigns a local board ID to the remote motion controller in the host system.

Mapping the remote controller into the local system allows you to configure the controller through MAX exactly as you would a controller that is in the host system. You can initialize the controller, download firmware, and use the interactive and configuration panels exactly as you would on a controller installed in the host machine. You also can write VIs using the remote motion controller through the local board ID assigned to it.

This allows you to write and debug your VIs on the host, and then download them to the remote system when you are ready. All you need to change is the board ID in your VI from the locally assigned Board ID to the ID assigned by the remote system.
13. Browse to **Devices and Interfaces** under **My System**, where there is a shortcut icon next to a new controller name.

For example, if the motion controller on the remote system is a PXI-7354, and the remote system has an IP address of 123.45.678.9, then the shortcut device would show a name like **PXI-7354 (X) on 123.45.678.9 (Y)**.

*X* is the board ID assigned to the board by the remote system. Use this board ID for VIs that are downloaded to the remote system through LabVIEW RT.

*Y* is the board ID assigned to the remote motion controller by the local system. Use this board ID for any VIs that run on the host and use the remote motion controller.
14. Close MAX.

# Step 4: Connect and Configure the NI UMI-7764

Complete the following steps to connect and configure your UMI-7764.



**Tip** For more information about connecting external power, encoders, and other motion I/O signals, refer to the *Universal Motion Interface (UMI)-7764 User Guide and Specifications*.

1. Connect the SH68-C68-S 68-pin shielded cable between the Motion I/O connector on the NI 73xx motion controller and the Motion I/O connector on the UMI-7764.
2. Configure the UMI-7764 DIP switches. You must set the DIP switches to the following settings to match the polarity configuration for the SMD-7610 stepper drive:
  - Inhibit Input (S2)—Active Low
  - Inhibit Output (S1)—Active Low

The UMI-7764 DIP switch configuration is shown in Figure 2.

**Figure 2.** UMI-7764 Inhibit Input and Inhibit Output DIP Switch Settings

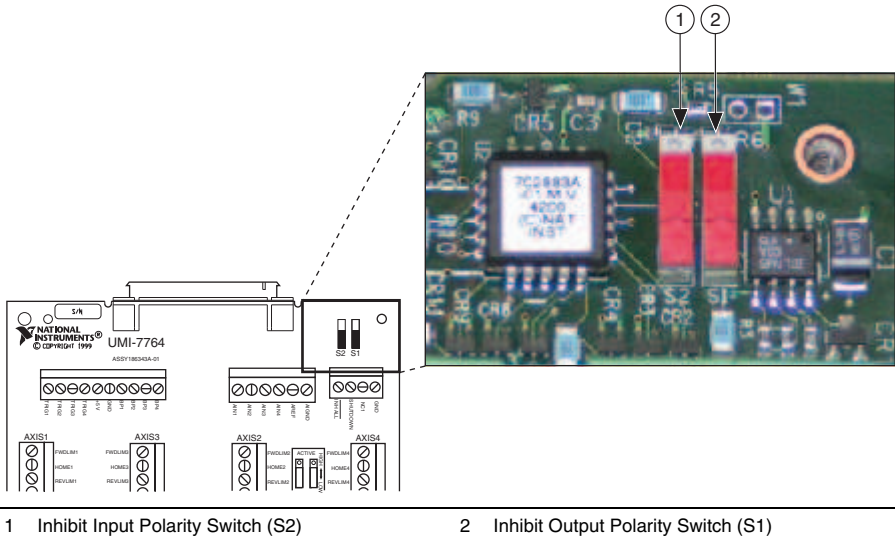

3. Connect an external +5 V power supply to the UMI-7764 Power Input Terminal Block. This connection is required to power the encoder circuitry that converts differential encoder signals to single-ended signals for the motion controller, as well as to power the UMI-7764 Inhibit Output signals.



**Caution** Do not plug in or turn on any power to the system until after all hardware connections are complete.



Figure 3 shows the location of the UMI 7764 Power Input Terminal Block.

**Figure 3.** UMI-7764 Power Input Terminal Block

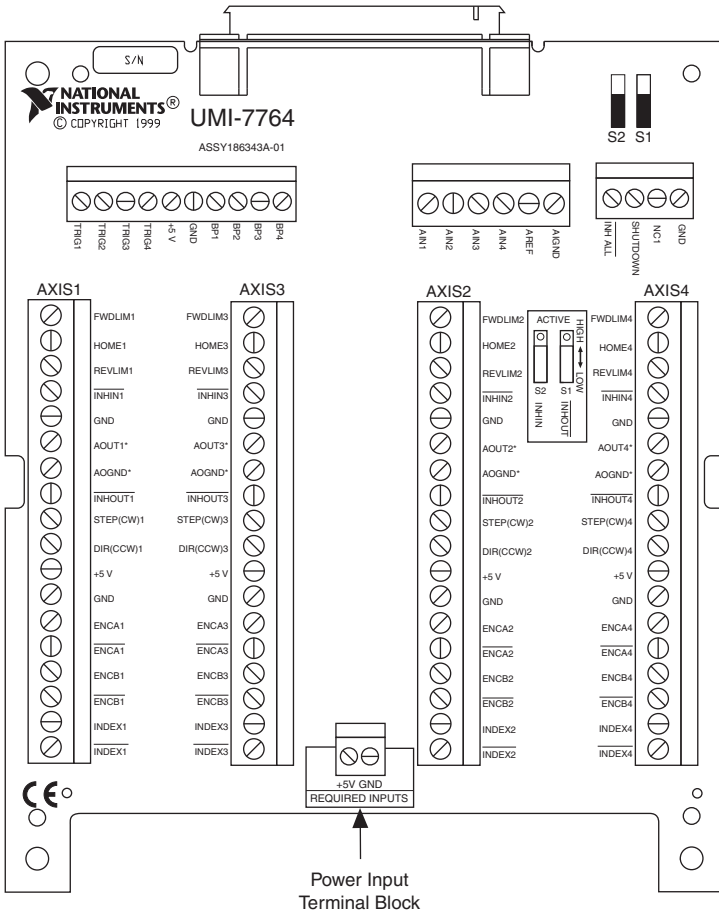

## Step 5: Connect the Drive Command Signals to the UMI-7764

Complete the following steps to connect the Drive Command signals to the UMI-7764.

1. Connect the SMD-7610 STEP terminal to the Motion I/O terminal block STEP (CW)1 terminal.
2. Connect the SMD-7610 DIR terminal to the Motion I/O terminal block DIR (CCW)1 terminal.
3. Connect the SMD-7610 COM+ terminal to the Motion I/O terminal block +5V terminal.

Figure 4 shows the SMD-7610 Drive Command and I/O Connector location and pinout.

**Figure 4. SMD-7610 Drive Command and I/O Connector**

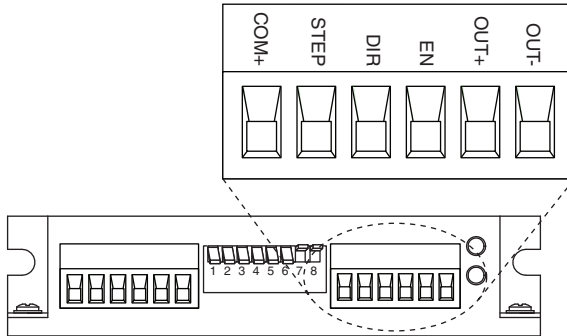
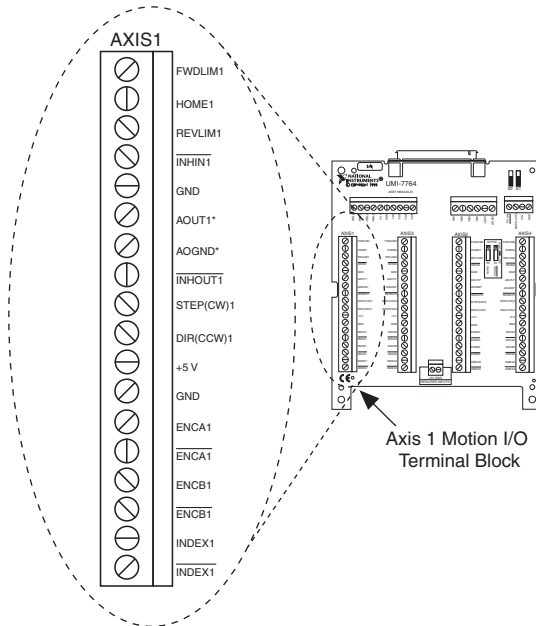

Figure 5 shows the UMI-7764 Motion I/O terminal block location and pinout.

**Figure 5. UMI-7764 Motion I/O Terminal Block**



## Step 6: Connect the Drive Enable Signal to the UMI-7764

The Drive Enable signal controls the enable function of the drive. To use this signal, connect the EN terminal to the Motion I/O terminal block  $\overline{\text{INHOUT1}}$  terminal.

## Step 7: (Optional) Connect the Drive Fault Signal to the UMI-7764

Complete the following optional steps to connect the drive fault signal to monitor the SMD-7610 for faults.

1. Connect the OUT+ terminal to the Motion I/O terminal block  $\overline{\text{INHIN1}}$  terminal.
2. Connect the OUT- terminal to the Motion I/O terminal block GND terminal.

## Step 8: (Optional) Connect the Encoder Signals to the UMI-7764

If your motor includes an encoder, connect the encoder signals to the UMI-7764.

1. Connect one end of the encoder cable to the encoder.
2. Cut the 15-pin DSUB connector off of the other end of the cable and expose the encoder wires.
3. Connect the encoder wires to the UMI-7764 as indicated in Table 1.
4. Insulate any unused wires.

**Table 1.** Encoder to UMI-7764 Motion I/O Terminal Block Connections

Encoder Signal Name	Encoder Cable Wire Color	Motion I/O Terminal Block Signal Name
A	blue	ENCA1
$\overline{\text{A}}$	blue/white	$\overline{\text{ENCA1}}$
B	yellow	ENCB1
$\overline{\text{B}}$	yellow/white	$\overline{\text{ENCB1}}$
I	orange	INDEX1
$\overline{\text{I}}$	orange/white	$\overline{\text{INDEX1}}$
GND	black	GND
+5V	red	+5 V

## Step 9: Connect the NI PS-12/13 Power Supply to the NI SMD-7610



**Note** Do not plug in or turn on the power supply until after you complete [Step 12: Power on the Drive and Verify Connections](#).

Complete the following steps to connect the power supply to AC input power and to the NI SMD-7610. Figure 6 shows the power supply terminals.

**Figure 6.** NI PS-12/13 Power Supply Terminals

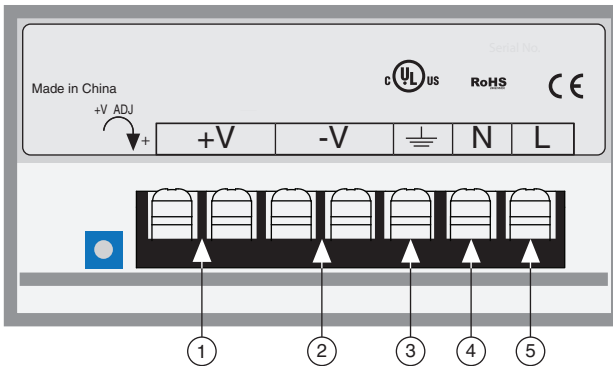

- |   |   |   |                  |
|---|---|---|------------------|
| 1 | +24 V (NI PS-12) or +48 V (NI PS-13) Output | 4 | AC Input Neutral |
| 2 | +24 V (NI PS-12) or +48 V (NI PS-13) Ground | 5 | AC Input Line    |
| 3 | AC Input Ground (Protective Earth)          |   |                  |

Figure 7 shows the SMD-7610 Power and Motor Connector location and pinout.

**Figure 7.** SMD-7610 Power and Motor Connector

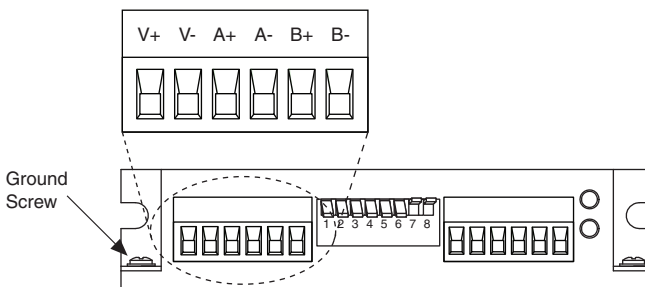

1. Connect an AC input cable to the line, neutral, and protective earth connectors.
2. Connect the SMD-7610 V+ terminal to the power supply +V connector.
3. Connect the SMD-7610 V- terminal to the power supply -V connector.

4. Connect the SMD-7610 green ground screw to earth ground.
5. Connect the NI UMI power supply ground/common terminal and NI PS-12/13 power supply ground connections to ensure a common reference.



**Note** Refer to the *NI SMD-7610 User Manual* for more information about connecting the power supply.

## Step 10: Connect the SMD-7610 to the Motor

NI offers stepper motors matched to the SMD-7610. The ST8-1, ST8-2, ST11-1, ST11-2, and ST14-1 are four lead motors. Connect them as shown in Figure 8.



**Note** Motor wire colors are correct for NI stepper motors compatible with the NI SMD-7610. These wire colors may not match a third-party stepper motor.

**Figure 8. Four Lead Motor Connection**

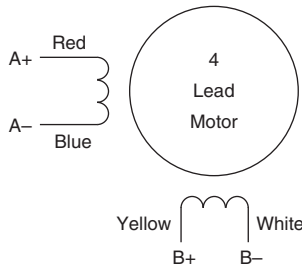

The ST17-1, ST17-2, and ST17-3 are eight lead motors that are connected using a parallel configuration. Connect them as shown in Figure 9.

**Figure 9. Eight Lead Motor Parallel Connection**

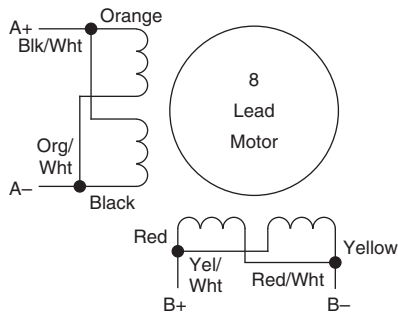

The ST23-2, ST23-4, and ST23-6 are eight lead motors that are connected using a series configuration. Connect them as shown in Figure 10.

**Figure 10. Eight Lead Motor Series Connection**

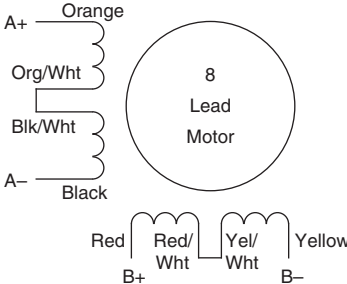

### Step 11: Configure the NI SMD-7610 DIP Switches

The NI SMD-7610 provides two sets of drive configuration DIP switches. Refer to the *NI SMD-7610 User Manual* for more information about the DIP switch options. The following figure shows the DIP switch locations and functions.



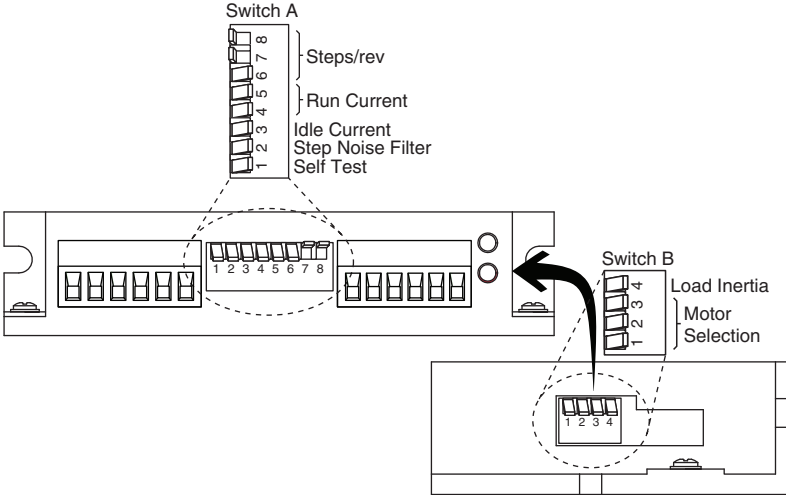

**Note** If you change the DIP switch settings you must power cycle the NI SMD-7610 for the new settings to take effect.

**Figure 11. NI SMD-7610 DIP Switches**





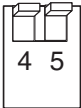
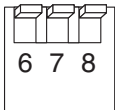

Refer to Table 2 for the DIP switch settings that this document uses.

**Table 2.** Switch A DIP Switch Settings

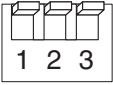
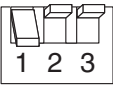
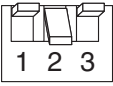
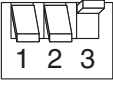
Setting Name	Switch Position	Corresponding Value
Self Test	 1	Off
Step Noise Filter	 2	2 MHz
Idle Current	 3	50%
Running Current	 4 5	100%
Steps/rev	 6 7 8	20000

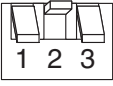
**Table 3. Switch B DIP Switch Settings**

Setting Name	Switch Position	Corresponding Value	Wiring
Motor Selection		ST8-1 ST8-2	4 leads
		ST11-1 ST11-2	4 leads
		ST14-1	4 leads
		ST17-1	parallel
		ST17-2 ST17-3	parallel
		ST23-2 ST23-4 ST23-6	series
Load Inertia		0 - 4X	—



# Step 12: Power on the Drive and Verify Connections

After all hardware connections have been made complete the following steps to confirm the hardware setup.

1. Turn on all power supplies.
2. Verify that the Drive Status LED on the NI SMD-7610 flashes or is solid green. Figure 12 shows the location of the Drive Status LED.

**Figure 12.** Drive Status LED Location

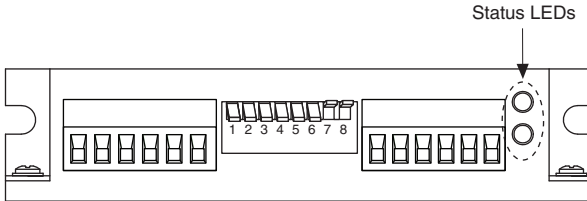

If the Drive Status LED does not flash or turn solid green, turn off all power, verify the connections, and try again.



## Software Installation and Configuration

This section covers installing and configuring the software for the NI 7330/7340/7350 motion controller.

### Step 1: Update Firmware on the Motion Controller

Firmware is software that is loaded onto the motion controller. Firmware allows you to update the motion controller with new features and updates. The latest firmware is automatically installed on the computer when you install the latest version of NI-Motion. You must download the firmware to the motion controller.

Complete the following steps to download firmware to an NI motion controller:

1. Click the MAX icon on the desktop (  ), or select **Start»All Programs»National Instruments»Measurement & Automation** to open MAX.
2. Expand **Devices and Interfaces**, and then expand **NI Motion Devices** in the configuration tree.
3. Select the motion controller for which you want to download firmware. An exclamation point on the NI 7330/7340/7350 motion controller icon (  ) indicates that the firmware is outdated and must be updated.
4. Click the **Firmware** tab at the bottom of the window. An exclamation point appears for each firmware sector that requires an update.
5. Click the **Update Firmware** button at the top of the window to update all the firmware files on your device.

## Step 2: Configure the NI Motion Controller

Complete the following steps to configure the NI 7330/7340/7350 motion controller for use with the SMD-7610.

1. Open MAX, if it is not already open.
2. Expand **Devices and Interfaces**, expand **NI Motion Devices**, and then select the appropriate motion controller in the configuration tree.
3. Expand the NI motion controller configuration tree item and click **Default 73xx Settings**.
4. Select **Open Loop Stepper** from the **Default Configurations** section.
5. Expand **Default 73xx Settings**, and then expand the axis associated with the NI SMD-7610 stepper drive.
6. Click **Axis Configuration** and set **Type** to **Stepper**.
7. Click the **Stepper Settings** tab on the bottom of the window and set **Stepper steps per revolution** to 20,000.



**Note** The **Stepper steps per revolution** setting *must* match the Steps/rev DIP switch setting on the NI SMD-7610. If you change the Steps/rev setting using the DIP switches, update this setting to match.

8. Click **Motion I/O Settings** and select **Disabled** for the **Forward Limit Switch**, **Reverse Limit Switch**, and **Home Switch**.



**Note** These configuration settings disable limits for initial setup and testing purposes. National Instruments recommends connecting and enabling limits in your final application.

9. Set the limit and home input active state to **Active Low Polarity**. This prevents the limit active error from occurring when no limits are connected.
10. Set **Inhibit Output Settings** to **Active Low Polarity**.
11. (Optional) Click **Encoder Settings**.
  - a. In the **Polarities** section confirm that the **Line State** for **A**, **B**, and **Index** is set to **Active High**.
  - b. In the **Index Reference Criteria** section confirm that the **Line State** for **A** and **B** is set to **Inactive**.
  - c. Set Encoder counts per revolution to 8,000. This setting is the encoder resolution in quadrature counts per revolution and corresponds to the encoder lines per revolution multiplied by four.
12. Click **Initialize** on the toolbar to send the updated settings to the motion controller. Initializing the motion controller resets it to a known starting state so that it is ready for commands.

# Step 3: Test the Motor In MAX

You will now move the motor using the NI motion controller and MAX. Select the **1-D Interactive** panel in the Configuration tree and change the settings to match those shown in Figure 13. Change the axis if you are not using Axis 1.

**Figure 13.** 1-D Interactive Panel Settings

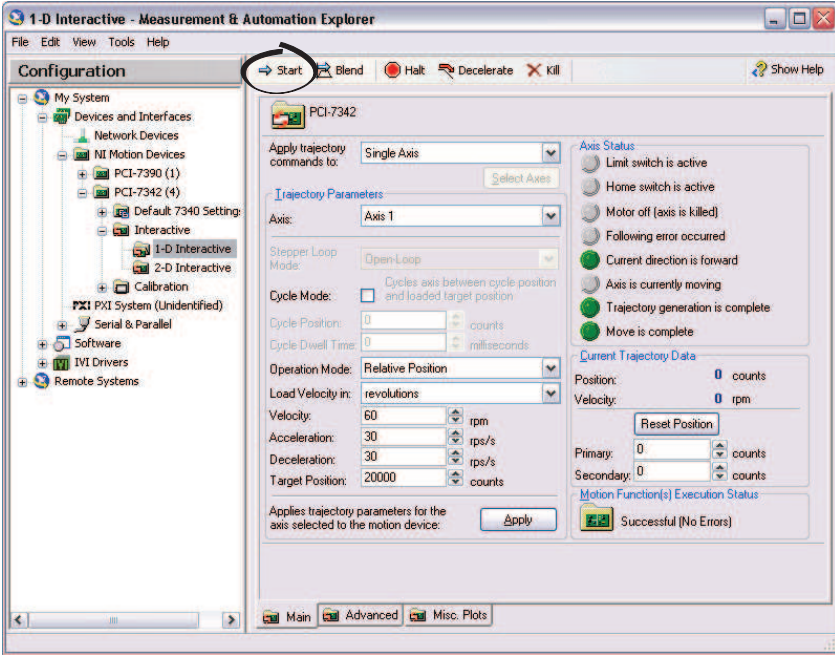

13. Click **Start**. Your motor should rotate 1 revolution at 60 rpm.
14. Finalize your motion system setup by connecting and configuring additional I/O such as limits as required by your application. Use the available screw-terminal connections on the same axis terminal block as the SMD-7610 connections.

# Where to Go Next

---

The following documents contain additional information that you may find helpful. All referenced documents ship with the product and are available at [ni.com/manuals](http://ni.com/manuals).

- *NI 7330 User Manual, NI 7340 User Manual, or NI 7350 User Manual*—Describes the electrical and mechanical aspects of the NI 7330/7340/7350 motion controller, and contains information about installing and operating the device.
- *Getting Started with NI-Motion for NI 73xx Motion Controllers*—Provides instructions for installing and getting started with the NI-Motion driver software and NI motion controllers.
- *NI SMD-7610 User Manual*
- *NI-Motion Help*—Contains information about designing a basic move, designing a multi-axis move, incorporating image and data acquisition into motion applications, and working with common motion concepts, such as contouring and breakpoints. This document is task-based and takes you through each phase of designing and executing a motion application.
- *NI-Motion Function Help*—Contains function reference information for C and Visual Basic and provides details about each function, including a description of the function, a list of the function parameters, illustrations, and error codes.
- *NI-Motion VI Help*—Contains LabVIEW VI reference information and provides details about each VI, including VI descriptions, lists of VI parameters, usage, illustrations, and error codes.
- *Measurement & Automation Explorer Help for Motion*—Provides information about using MAX to configure the NI motion controller as well as advanced conceptual information about topics such as Bode analysis and control loop parameters.
- *Getting Started with LabVIEW*—Use this document as a tutorial to familiarize yourself with the LabVIEW graphical programming environment and the basic LabVIEW features you use to build data acquisition and instrument control applications. Access the *Getting Started with LabVIEW* PDF by selecting **Start»All Programs»National Instruments»LabVIEW»LabVIEW Manuals»LV\_Getting\_Started.pdf**.

# Worldwide Support and Services

---

The National Instruments Web site is your complete resource for technical support. At [ni.com/support](http://ni.com/support) you have access to everything from troubleshooting and application development self-help resources to email and phone assistance from NI Application Engineers.

Visit [ni.com/services](http://ni.com/services) for NI Factory Installation Services, repairs, extended warranty, calibration, and other services.

Visit [ni.com/register](http://ni.com/register) to register your National Instruments product. Product registration facilitates technical support and ensures that you receive important information updates from NI.

A Declaration of Conformity (DoC) is our claim of compliance with the Council of the European Communities using the manufacturer's declaration of conformity. This system affords the user protection for electromagnetic compatibility (EMC) and product safety. You can obtain the DoC for your product by visiting [ni.com/certification](http://ni.com/certification). If your product supports calibration, you can obtain the calibration certificate for your product at [ni.com/calibration](http://ni.com/calibration).

National Instruments corporate headquarters is located at 11500 North Mopac Expressway, Austin, Texas, 78759-3504. National Instruments also has offices located around the world to help address your support needs. For telephone support in the United States, create your service request at [ni.com/support](http://ni.com/support) and follow the calling instructions or dial 512 795 8248. For telephone support outside the United States, visit the Worldwide Offices section of [ni.com/niglobal](http://ni.com/niglobal) to access the branch office Web sites, which provide up-to-date contact information, support phone numbers, email addresses, and current events.

Refer to the *NI Trademarks and Logo Guidelines* at [ni.com/trademarks](http://ni.com/trademarks) for more information on National Instruments trademarks. Other product and company names mentioned herein are trademarks or trade names of their respective companies. For patents covering National Instruments products/technology, refer to the appropriate location: **Help»Patents** in your software, the `patents.txt` file on your media, or the *National Instruments Patents Notice* at [ni.com/patents](http://ni.com/patents). You can find information about end-user license agreements (EULAs) and third-party legal notices in the readme file for your NI product. Refer to the *Export Compliance Information* at [ni.com/legal/export-compliance](http://ni.com/legal/export-compliance) for the National Instruments global trade compliance policy and how to obtain relevant HTS codes, ECCNs, and other import/export data.