

COMPREHENSIVE SERVICES

We offer competitive repair and calibration services, as well as easily accessible documentation and free downloadable resources.

SELL YOUR SURPLUS

We buy new, used, decommissioned, and surplus parts from every NI series. We work out the best solution to suit your individual needs.

 Sell For Cash  Get Credit  Receive a Trade-In Deal

OBSOLETE NI HARDWARE IN STOCK & READY TO SHIP

We stock **New**, **New Surplus**, **Refurbished**, and **Reconditioned** NI Hardware.



Bridging the gap between the manufacturer and your legacy test system.

 1-800-915-6216

 www.apexwaves.com

 sales@apexwaves.com

All trademarks, brands, and brand names are the property of their respective owners.

Request a Quote

 **CLICK HERE**

UMI-7764

GETTING STARTED

NI SMD-7611/7612 Stepper Drives and NI 73xx Motion Controllers

This document explains how to install and configure the NI SMD-7611/7612 stepper drives for use with the NI 7330/7340/7350 motion controllers.



Tip If you encounter any problems during setup, refer to the [Worldwide Support and Services](#) section for assistance.

Contents

Connecting and Using the NI SMD-7611/7612 with the NI UMI-7772/7774	2
What You Need to Get Started	2
Hardware	2
Software	3
NI Motion Controller Configuration and Installation	4
Step 1: Install NI-Motion	4
Step 2: Install the NI 73xx Motion Controller	5
Step 3: Install Software on and Configure the RT PXI Controller (PXI Motion Controllers Only)	6
NI UMI-7772/7774 and NI SMD-7611/7612 Configuration and Installation	7
Step 1: Connect and Configure the UMI-7772/7774	8
Step 2: Connect the Drive Command Signals to the UMI-7772/7774	9
Step 3: Connect the Drive Enable Signal to the UMI-7772/7774	10
Step 4: (Optional) Connect the Drive Fault Signal to the UMI-7772/7774	10
Step 5: (Optional) Connect the Encoder Signals to the UMI-7772/7774	11
Step 6: Connect the NI PS-12/13 Power Supply to the NI SMD-7611/7612	11
Step 7: Connect the SMD-7611/7612 to the Motor	13
Step 8: Set the Motor Selection Switch	14
Step 9: Configure the NI SMD-7611/7612 DIP Switches	16
Step 10: Power on the Drive and Verify Connections	17
Connecting and Using the NI SMD-7611/7612 with the NI UMI-7764	18
What You Need to Get Started	18
Hardware	18
Software	19
NI Motion Controller Configuration and Installation	20
Step 1: Install NI-Motion	20
Step 2: Install the NI 73xx Motion Controller	20
Step 3: Install Software on and Configure the RT PXI Controller (PXI Motion Controllers Only)	22

NI UMI-7764 and NI SMD-7611/7612 Configuration and Installation	23
Step 1: Connect and Configure the NI UMI-7764.....	23
Step 2: Connect the Drive Command Signals to the UMI-7764	25
Step 3: Connect the Drive Enable Signal to the UMI-7764	27
Step 4: (Optional) Connect the Drive Fault Signal to the UMI-7764.....	27
Step 5: (Optional) Connect the Encoder Signals to the UMI-7764	27
Step 6: Connect the NI PS-12/13 Power Supply to the NI SMD-7611/7612	28
Step 7: Connect the SMD-7611/7612 to the Motor	29
Step 8: Set the Motor Selection Switch	30
Step 9: Configure the NI SMD-7611/7612 DIP Switches	32
Step 10: Power on the Drive and Verify Connections.....	33
Software Installation and Configuration	34
Step 1: Update Firmware on the Motion Controller	34
Step 2: Configure the NI Motion Controller.....	34
Step 3: Test the Motor In MAX.....	36
Where to Go Next	37
Worldwide Support and Services	38

Connecting and Using the NI SMD-7611/7612 with the NI UMI-7772/7774

What You Need to Get Started

You need the following items to get started.

Hardware

- A computer with an available PXI or PCI slot
- NI 7330, NI 7340, or NI 7350 motion controller
- UMI-7772/7774
- SHC68-C68-S cable to connect your NI UMI and motion controller
- (optional) DB9M/DB15M/DB25M cables for UMI-7772/7774 connectivity
- +24 ±10% VDC power supply (10 W minimum) for the NI UMI-7772/7774
- (Optional) +5 to +30 V isolated power supply (10 to 60 W minimum, depending on I/O requirements)



Note The same power supply may be used for both the main +24 V power supply and I/O. However, if you use the same power supply for both connections, there will be no isolation between the I/O and the main power.

- Snap-on ferrite beads for the power supply cable(s) (included with your NI UMI-7772 or NI UMI-7774). You must use a separate ferrite bead for each power supply cable. Refer to the *NI UMI-7772/7774 User Guide and Specifications* for installation information.
- NI SMD-7611/7612 stepper drive
- NI PS-12 or NI PS-13 power supply for the NI SMD-7611/7612
- NI or third-party stepper motor



Note NI offers stepper motors matched to the NI SMD-7611/7612. Refer to ni.com/motion for motor options. National Instruments highly recommends using these motors for the best user experience.

- (optional) ENC-7740 encoder for ST17 motors (NI part number 748991-01) or ENC-7741 encoder for ST23 motors (NI part number 748992-01)
- NI-7748 encoder cable to connect the encoder to the NI UMI-7772/7774 (NI part number 748994-01)

Software

- NI-Motion 7.6 or later driver software



Tip Refer to KB 4WRDJ3WA, *Which LabVIEW Version Supports NI-Motion?*, at ni.com/kb, for NI-Motion/LabVIEW version compatibility information.

- One of the following software packages and documentation:
 - LabVIEW 8.5 or later
 - LabWindows™/CVI™ 8.5 or later
 - Microsoft Visual C++ 6.0
 - Microsoft Visual Basic 6.0

Figure 1 shows the hardware connections using a UMI-7772/7774.

Figure 1. UMI-7772/7774 to SMD-7611/7612 Drive Connections

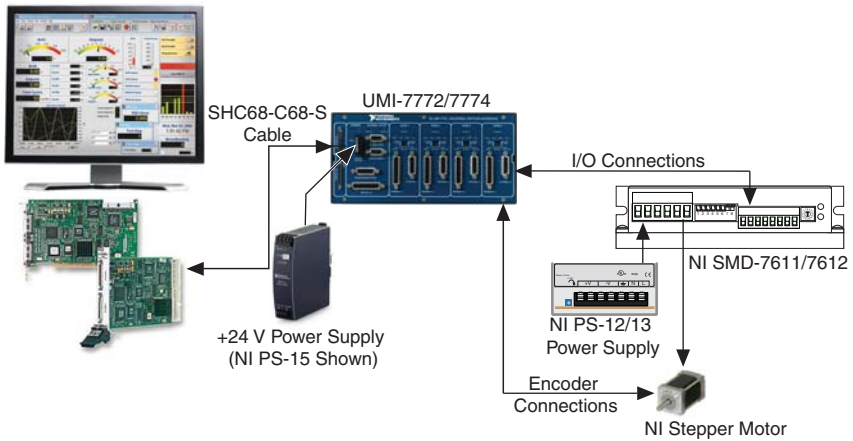

NI Motion Controller Configuration and Installation



Caution Before installing the NI 7330/7340/7350 motion controller refer to the user manual appropriate to your controller for safety and specification information. Failure to follow safety instructions may result in damage to equipment.

Step 1: Install NI-Motion

You must install the NI-Motion driver software *before* installing an NI motion controller for the first time. If you are upgrading from a previous version of NI-Motion, it is not necessary to remove the NI motion controller before installing the upgrade. The upgrade does not affect the existing Microsoft Windows configuration.



Note If you are using a Real-Time OS, install LabVIEW Real-Time on the development computer before installing NI-Motion so that the RT support files install.

Complete the following steps to install the NI-Motion driver software:

1. Insert the NI-Motion CD into the CD-ROM drive to display the NI-Motion installation screen, or download the latest version from ni.com/downloads.
2. If you have autorun enabled, `autorun.exe` runs automatically. Otherwise, double-click `autorun.exe`.
3. Follow the onscreen instructions.



Note You must update the firmware on your NI motion controller(s) before you can use them with the corresponding version of NI-Motion. Refer to [Step 1: Update Firmware on the Motion Controller](#) in the [Software Installation and Configuration](#) section for detailed instructions.

Step 2: Install the NI 73xx Motion Controller

The following sections explain how to install PXI and PCI motion controllers.



Note When adding or removing the motion controller, you must be logged on with administrator-level access. After you have restarted the system, you may need to refresh Measurement & Automation Explorer (MAX) to view the new controller.

PXI Controllers

1. Power off and unplug the chassis.



Caution To protect yourself and the computer from electrical hazards, the computer *must* remain unplugged until the installation is complete.

2. Choose an unused peripheral slot and remove the filler panel.
3. Touch a metal part on the chassis to discharge any static electricity that might be on your clothes or body. Static electricity can damage the controller.
4. Insert the PXI controller into the chosen slot. Use the injector/ejector handle to fully secure the device into place.
5. Attach the front panel of the PXI controller to the front panel mounting rails of the chassis with the slot screws on the chassis.



Caution Always power on the computer containing the motion controller and initialize the controller before you power on the rest of the motion system. Power off the motion system in the reverse order.

6. Plug in and power on the chassis.

PCI Controllers

1. Power off and unplug the computer.



Caution To protect yourself and the computer from electrical hazards, the computer *must* remain unplugged until the installation is complete.

2. Open the computer case to expose access to the PCI expansion slots.
3. Touch a metal part on the chassis to discharge any static electricity that might be on your clothes or body. Static electricity can damage the controller.
4. Choose an unused +3.3 V or +5 V PCI slot, and remove the corresponding expansion slot cover on the back panel of the computer.
5. Gently rock the controller into the slot. The connection may be tight, but do *not* force the controller into place.



Note Check that the bracket of the device aligns with the hole in the back panel rail of the computer chassis.

6. Secure the mounting bracket of the controller to the back panel rail of the computer.
7. Replace the cover.



Caution Always power on the computer containing the motion controller, and then initialize the controller before you power on the rest of the motion system. Power off the motion system in the reverse order.

8. Plug in and power on the computer.

Step 3: Install Software on and Configure the RT PXI Controller (PXI Motion Controllers Only)



Note This step is only required if you are using a PXI-7330/7340/7350 motion controller and an RT PXI controller. If you are not using an RT PXI controller, skip to the [NI UMI-7772/7774](#) and [NI SMD-7611/7612 Configuration and Installation](#) section.

Complete the following steps to configure the controller and install software on it.



Note The Measurement & Automation Explorer (MAX) user interface may not match these steps exactly depending on which version of MAX you are using.

1. Boot the NI PXI embedded controller into the real-time operating system. The PXI controller automatically boots into LabVIEW RT Safe Mode when no software is installed. LabVIEW RT Safe Mode loads with the basic real-time operating system and automatically attempts to connect to the network using DHCP. If DHCP is not available, the controller connects to the network with a link-local IP address.



Tip You can connect a monitor to the PXI to display startup messages such as the IP address and MAC address.

2. Launch Measurement & Automation Explorer (MAX) on the development computer by clicking the MAX icon on the desktop (), or by selecting **Start»All Programs»National Instruments»Measurement & Automation**.
3. Expand the **Remote Systems** branch. MAX lists the PXI controller as the model name of the controller followed by the MAC address (for example, **NI-PXI-8104 00802f108562**).



Tip Record the PXI controller MAC address, located on the side of the controller, for use in identifying the controller. The label also can be removed and placed on the front of the controller for easier access. If you have connected the PXI controller to a monitor, the MAC address also appears when the PXI system boots up.

4. Select the **System Settings** tab and type a descriptive name for the system in the **Name** field.

- (Optional) Complete this step only if the target has an empty IP address (0.0.0.0). Select the **Network Settings** tab and select **DHCP or Link Local** from the **Configure IPv4 Address** list to assign an IP address or select **Static** to specify a static IP address in the **IPv4 Address** section.
- Click **Save** on the toolbar and let MAX reboot the system.
- When the new system name appears under **Remote Systems**, expand the controller item in the tree, right-click **Software**, and select **Add/Remove Software**.
- Install the LabVIEW Real-Time software and NI-Motion on the RT target. Go to ni.com/info and enter `etspc` for the latest information about supported software.
- Click **Next** to install the selected software on the controller. Click **Help** if you need information about installing recommended software sets.
- Wait for installation to complete, then click **Finish**.
- Expand the **Devices and Interfaces** item under the PXI system.
- Right-click the remote motion controller icon and select **Map to Local Machine**. This assigns a local board ID to the remote motion controller in the host system.

Mapping the remote controller into the local system allows you to configure the controller through MAX exactly as you would a controller that is in the host system. You can initialize the controller, download firmware, and use the interactive and configuration panels exactly as you would on a controller installed in the host machine. You also can write VIs using the remote motion controller through the local board ID assigned to it.

This allows you to write and debug your VIs on the host, and then download them to the remote system when you are ready. All you need to change is the board ID in your VI from the locally assigned Board ID to the ID assigned by the remote system.

- Browse to **Devices and Interfaces** under **My System**, where there is a shortcut icon next to a new controller name.

For example, if the motion controller on the remote system is a PXI-7354, and the remote system has an IP address of 123.45.678.9, then the shortcut device would show a name like **PXI-7354 (X) on 123.45.678.9 (Y)**.

X is the board ID assigned to the board by the remote system. Use this board ID for VIs that are downloaded to the remote system through LabVIEW RT.

Y is the board ID assigned to the remote motion controller by the local system. Use this board ID for any VIs that run on the host and use the remote motion controller.

- Close MAX.

NI UMI-7772/7774 and NI SMD-7611/7612 Configuration and Installation

This section covers the hardware setup for the NI UMI-7772/7774 and NI SMD-7611/7612 stepper drive. If you are using a UMI-7764 refer to the [Connecting and Using the NI SMD-7611/7612 with the NI UMI-7764](#) section.

Step 1: Connect and Configure the UMI-7772/7774

Complete the following steps to connect and configure the UMI-7772/7774.



Tip For more information about connecting external power, encoders, and other motion I/O signals to the UMI-7772/7774, refer to the *National Instruments Universal Motion Interface (UMI)-7772/7774 User Manual and Specifications*.

1. Connect the SHC68-C68-S 68-pin shielded cable between the Motion I/O connector on the NI 73xx motion controller and the Motion I/O connector on the UMI-7772/7774.
2. Configure the UMI-7772/7774 DIP switches. You must set the UMI-7772/7774 switches to the following settings to match the polarity configuration for the NI SMD-7611/7612:
 - Fault—Active High
 - Enable—Active High

The UMI-7772/7774 DIP switch configuration is shown in Figure 2.

Figure 2. UMI-7772/7774 Fault and Enable DIP Switch Settings

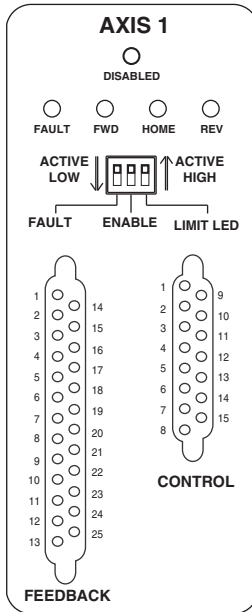

Note Configuring the limit and home status LEDs on the UMI-7772/7774 does not configure the limit and home inputs themselves as active-high or active-low. You must configure the limit and home inputs separately on the National Instruments motion controller using MAX or the NI-Motion driver software. This DIP switch does not need to be configured when the UMI-7772/7774 is used with the NI SMD-7611/7612 stepper drives.

- Connect the positive lead of the +24 V external power supply to the V terminal and the negative lead to the C terminal, then connect the V terminal to the V_{iso} terminal and the C terminal to the C_{iso} terminal. If you require isolation, you can connect a separate 5 to 30 VDC power supply to the V_{iso} and C_{iso} terminals to use the isolation feature of the UMI-7772/7774. Refer to the *NI UMI-7772/7774 User Guide and Specifications* for more information.



Caution Do not plug in or turn on any power to the system until after all hardware connections are complete.

Figure 3 shows the power terminal block.

Figure 3. UMI-7772/7774 Power Connection

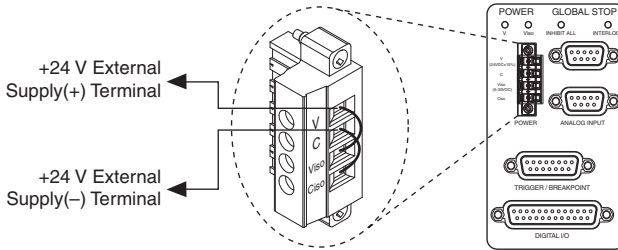

Step 2: Connect the Drive Command Signals to the UMI-7772/7774

Complete the following steps to connect the Drive Command signals to the UMI-7772/7774.

- Connect the DB15M pigtail cable to the UMI-7772/7774 Axis 1 Control connector.
- Connect the SMD-7611/7612 STEP- terminal to the DB15M cable pin 4 wire (orange) which corresponds to the UMI-7772/7774 Step (CW) terminal.
- Connect the SMD-7611/7612 DIR- terminal to the DB15M cable pin 12 wire (light green) which corresponds to the UMI-7772/7774 Dir (CCW) terminal.
- Connect the SMD-7611/7612 STEP+ and DIR+ terminals to the DB15M cable pin 3 wire (red) which corresponds to the UMI-7772/7774 +5V OUT terminal.

Figure 4 shows the SMD-7611/7612 Drive Command and I/O Connector location and pinout.

Figure 4. SMD-7611/7612 Drive Command and I/O Connector

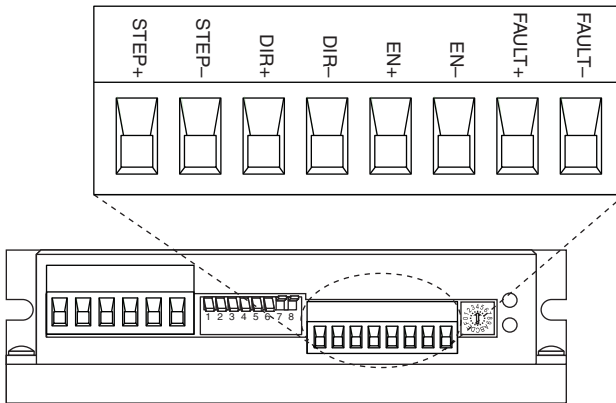

Step 3: Connect the Drive Enable Signal to the UMI-7772/7774

Complete the following steps to connect the Drive Enable signal, which controls the enable function of the drive:

1. Connect the EN+ terminal to the DB15M cable pin 6 wire (green) which corresponds to the UMI-7772/7774 Enable terminal.
2. Connect the EN- terminal to the DB15M cable pin 15 wire (red/white) which corresponds to the UMI-7772/7774 C_{iso} terminal.

Step 4: (Optional) Connect the Drive Fault Signal to the UMI-7772/7774

Complete the following optional steps to connect the drive fault signal to monitor the NI SMD-7611/7612 for faults.

1. Connect the FAULT+ terminal to the DB15M cable pin 8 wire (purple) which corresponds to the UMI-7772/7774 V_{iso} terminal.
2. Connect the FAULT- terminal to the DB15M cable pin 7 wire (blue) which corresponds to the UMI-7772/7774 Fault+ terminal.
3. Connect the DB15M cable pin 14 wire (brown/white), which corresponds to the UMI-7772/7774 Fault- terminal to the DB15M cable pin 15 wire (red/white), which corresponds to the UMI-7772/7774 C_{iso} terminal.

Step 5: (Optional) Connect the Encoder Signals to the UMI-7772/7774

If your stepper motor includes an encoder, connect the encoder signals to the UMI-7772/7774.

1. Connect one end of the encoder cable to the encoder.
2. Cut the 15-pin DSUB connector off of the other end of the cable and expose the encoder wires.
3. Connect the encoder wires to the DB25M cable as indicated in Table 1.
4. Insulate any unused wires.

Table 1. Encoder to UMI-7772/7774 Connections

Encoder Signal Name	Encoder Cable Wire Color	DB25M Wire Number (Color)	UMI-7772/7774 Signal Name
CH A	blue	1 (black)	Encoder Phase A
CH A-	blue/white	14 (brown/white)	Encoder Phase A-
CH B	yellow	2 (brown)	Encoder Phase B
CH B-	yellow/white	15 (red/white)	Encoder Phase B-
INDEX	orange	3 (red)	Encoder Index
INDEX-	orange/white	16 (orange/white)	Encoder Index-
GND	black	17 (green/white)	Digital Ground
+Vcc	red	4 (orange)	+5V OUT

Step 6: Connect the NI PS-12/13 Power Supply to the NI SMD-7611/7612



Note Do not plug in or turn on the power supply until after you complete [Step 10: Power on the Drive and Verify Connections](#).

Complete the following steps to connect the power supply to AC input power and to the NI SMD-7611/7612. Figure 5 shows the power supply terminals.

Figure 5. NI PS-12/13 Power Supply Terminals

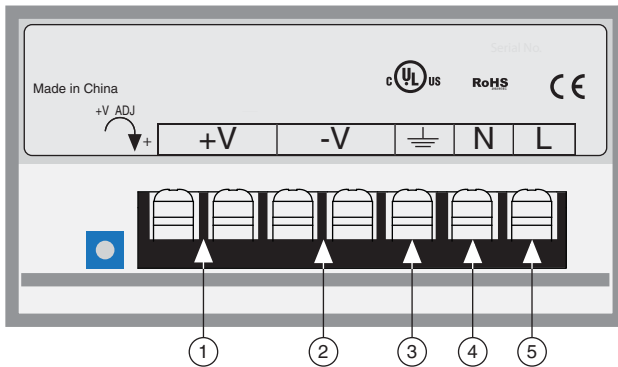

- | | | | |
|---|---|---|------------------|
| 1 | +24 V (NI PS-12) or +48 V (NI PS-13) Output | 4 | AC Input Neutral |
| 2 | +24 V (NI PS-12) or +48 V (NI PS-13) Ground | 5 | AC Input Line |
| 3 | AC Input Ground (Protective Earth) | | |

Figure 6 shows the SMD-7611/7612 Power and Motor Connector location and pinout.

Figure 6. SMD-7611/7612 Power and Motor Connector

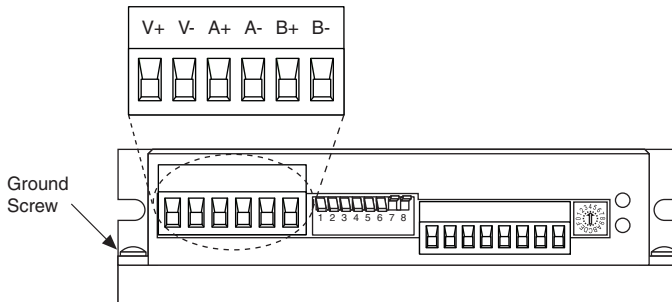

1. Connect an AC input cable to the line, neutral, and ground connectors.
2. Connect the SMD-7611/7612 V+ terminal to the power supply +V connector.
3. Connect the SMD-7611/7612 V- terminal to the power supply -V connector.
4. Connect the SMD-7611/7612 green ground screw to earth ground.
5. Connect the DB15M cable pin 11 wire (pink), which corresponds to the NI UMI-7772/7774 Digital Ground terminal, to the NI PS-12/13 power supply ground connection to ensure a common reference.



Note Refer to the *NI SMD-7611/7612 User Manual* for more information about connecting the power supply.

Step 7: Connect the SMD-7611/7612 to the Motor

NI offers stepper motors matched to the SMD-7611/7612. The ST24-1, ST24-2, and ST24-3 are four lead motors. Connect them as shown in Figure 7.



Note Motor wire colors are correct for NI stepper motors compatible with the NI SMD-7611/7612. These wire colors may not match a third-party stepper motor.

Figure 7. Four Lead Motor Connection

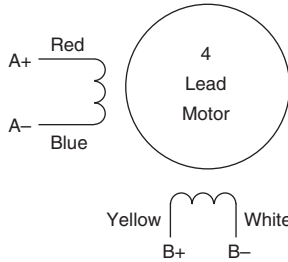

The ST17-1, ST17-2, ST17-3, ST17-4, ST23-1, ST23-4, ST23-6, ST23-8, ST34-4, and ST34-8 are eight lead motors that are connected using a parallel configuration. Connect them as shown in Figure 8.

Figure 8. Eight Lead Motor Parallel Connection

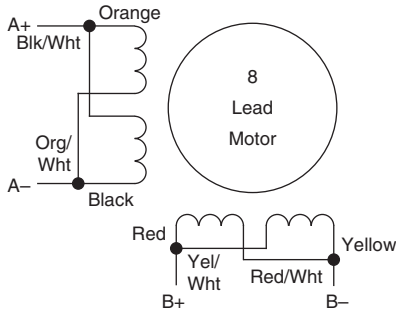

When using the SMD-7612, connect the ST34-1, ST34-2, and ST34-5 using a parallel configuration as shown in Figure 8.

When using the SMD-7611, connect the ST34-1, ST34-2, and ST34-5 using a series configuration as shown in Figure 9.

Figure 9. Eight Lead Motor Series Connection

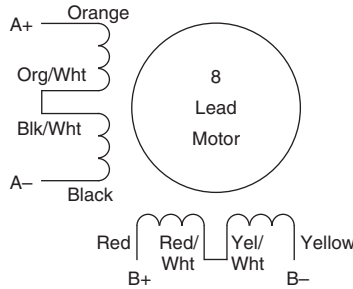

Step 8: Set the Motor Selection Switch

National Instruments offers stepper motors matched to the NI SMD-7611/7612. National Instruments highly recommends using these motors for the best user experience. Figure 10 shows the Motor Selection Switch location.

Figure 10. NI SMD-7611/7612 Motor Selection Switch

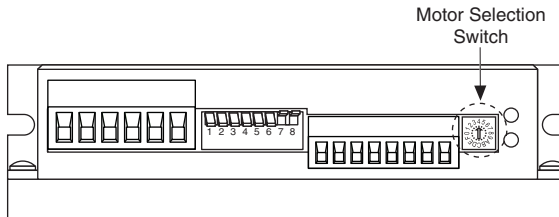

Tables 2 and 3 show the switch settings for compatible stepper motors for the SMD-7611 and SMD-7612, respectively. If you are not using a motor in the list, set the switch to a motor with a rotor inertia, holding torque, and current that are within 10% of your motor.

Table 2. NI SMD-7611 Motor Selection Switch Settings

Switch Setting	Motor	Wiring	Drive Current Amps, peak of sine	Holding Torque, (oz.-in)	Rotor Inertia (g-cm ²)
0	reserved for custom configurations				
1					
2	ST17-4	parallel	2.4	113	123
3	ST17-1	parallel	1.6	31.4	35
4	ST17-2	parallel	2	51	54

Table 2. NI SMD-7611 Motor Selection Switch Settings (Continued)

Switch Setting	Motor	Wiring	Drive Current Amps, peak of sine	Holding Torque, (oz.-in)	Rotor Inertia (g-cm ²)
5	ST17-3	parallel	2	62.8	68
6	ST23-1	parallel	3.4	76.6	120
7	ST23-4	parallel	4.5	159.3	300
8	ST23-6	parallel	4.5	237.6	480
9	ST24-1	4 leads	3.36	123	280
A	ST24-2	4 leads	4.5	166	450
B	ST24-3	4 leads	4.5	332	900
C	ST34-2	series	4.5	585	1400
D	ST34-5	series	4.5	1113	2680
E	ST34-1	series	3.816	396	1100

Table 3. NI SMD-7612 Motor Selection Switch Settings

Switch Setting	Motor	Wiring	Drive Current Amps, peak of sine	Holding Torque, oz.-in	Rotor Inertia g-cm ²
0	reserved for custom configurations				
1					
2					
3	ST23-8	parallel	6	354	750
4	ST23-1	parallel	3.4	76.6	120
5	ST23-4	parallel	5	177	300
6	ST23-6	parallel	5	264	480
7	ST24-1	4 leads	3.36	123	280
8	ST24-2	4 leads	4.8	177	450
9	ST24-3	4 leads	4.8	354	900
A	ST34-2	parallel	8	507	1400
B	ST34-5	parallel	8	965	2680

Table 3. NI SMD-7612 Motor Selection Switch Settings (Continued)

Switch Setting	Motor	Wiring	Drive Current Amps, peak of sine	Holding Torque, oz.-in	Rotor Inertia g-cm ²
C	ST34-8	parallel	8	1439	4000
D	ST34-1	parallel	7.56	396	1100
E	ST34-4	parallel	7.56	849	1850

Step 9: Configure the NI SMD-7611/7612 DIP Switches

The NI SMD-7611/7612 provides drive configuration DIP switches. Refer to the *NI SMD-7611/7612 User Manual* for more information about the DIP switch options. The following figure shows the DIP switch location and functions.



Note If you change the DIP switch settings you must power cycle the NI SMD-7611/7612 for the new settings to take effect.

Figure 11. NI SMD-7611/7612 DIP Switches

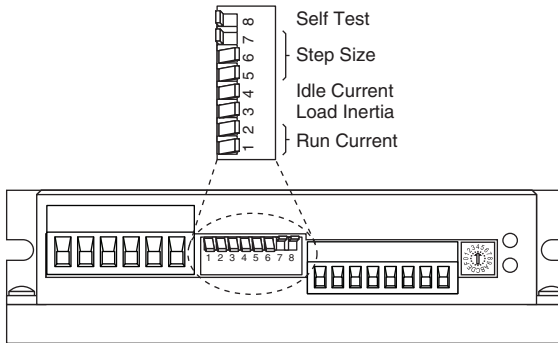

Refer to Table 4 for the DIP switch settings that this document uses.

Table 4. DIP Switch Settings





Setting Name	Switch Position	Corresponding Value
Running Current		100%
Load Inertia		0 - 4X

Table 4. DIP Switch Settings (Continued)

Setting Name	Switch Position	Corresponding Value
Idle Current		50%
Steps/rev		20000
Self Test		Off

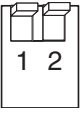
Step 10: Power on the Drive and Verify Connections

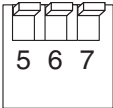
After all hardware connections have been made complete the following steps to confirm the hardware setup.

1. Turn on all power supplies.
2. Verify that the Drive Status LED on the NI SMD-7611/7612 flashes or is solid green. Figure 12 shows the location of the Drive Status LED.

Figure 12. Drive Status LED Location

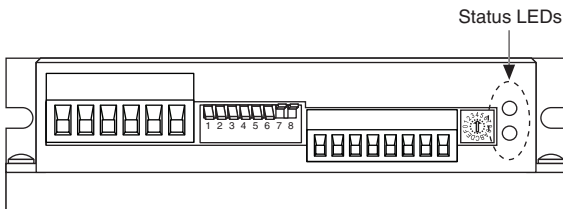

If the Drive Status LED does not flash or turn solid green, turn off all power, verify the connections, and try again. Refer to the [Worldwide Support and Services](#) section for additional tips.

3. Verify that the **V** LED on the UMI-7772/7774 illuminates. If the 24 VDC power supply has also been connected to the V_{iso} and C_{iso} terminals, the **Viso** LED illuminates. If you are using a separate power supply to provide isolation, power on the separate 5 to 30 V power

supply and the **Viso** LED indicator illuminates. Figure 13 shows the location of the **V** and **Viso** LEDs.

Figure 13. UMI-7772/7774 V and V_{iso} LED Location

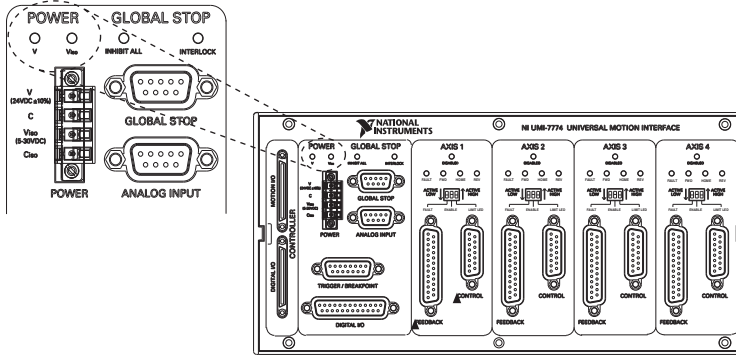

If the **V** and **Viso** LEDs do not illuminate, turn off all power, verify the connections, and try again. Refer to the [Worldwide Support and Services](#) section for additional tips.



Note Refer to the [Software Installation and Configuration](#) section after the [Connecting and Using the NI SMD-7611/7612 with the NI UMI-7764](#) section to continue setting up your system.

Connecting and Using the NI SMD-7611/7612 with the NI UMI-7764

What You Need to Get Started

You need the following items to get started.

Hardware

- A computer with an available PXI or PCI slot
- NI 7330, NI 7340, or NI 7350 motion controller
- UMI-7764
- SH68-C68-S cable to connect your NI UMI and motion controller
- +5 V power supply for the UMI-7764
- Snap-on ferrite bead for the power supply cable (included with your NI UMI-7764). Refer to the *UMI-7764 User Guide and Specifications* for installation information.
- NI SMD-7611/7612 stepper drive

- NI PS-12 or NI PS-13 power supply for the NI SMD-7611/7612
- NI or third-party stepper motor



Note NI offers stepper motors matched to the NI SMD-7611/7612. Refer to ni.com/motion for motor options. National Instruments highly recommends using these motors for the best user experience.

- (optional) ENC-7740 encoder for ST17 motors (NI part number 748991-01) or ENC-7741 encoder for ST23 motors (NI part number 748992-01)
- NI-7748 encoder cable to connect the encoder to the UMI-7764 (NI part number 748994-01)

Software

- NI-Motion 7.6 or later driver software



Tip Refer to KB 4WRDJ3WA, *Which LabVIEW Version Supports NI-Motion?*, at ni.com/kb, for NI-Motion/LabVIEW version compatibility information.

- One of the following software packages and documentation:
 - LabVIEW 8.5 or later
 - LabWindows/CVI 8.5 or later
 - Microsoft Visual C++ 6.0
 - Microsoft Visual Basic 6.0

Figure 14 shows the hardware connections using a UMI-7764.

Figure 14. UMI-7764 to NI SMD-7611/7612 Drive Connections

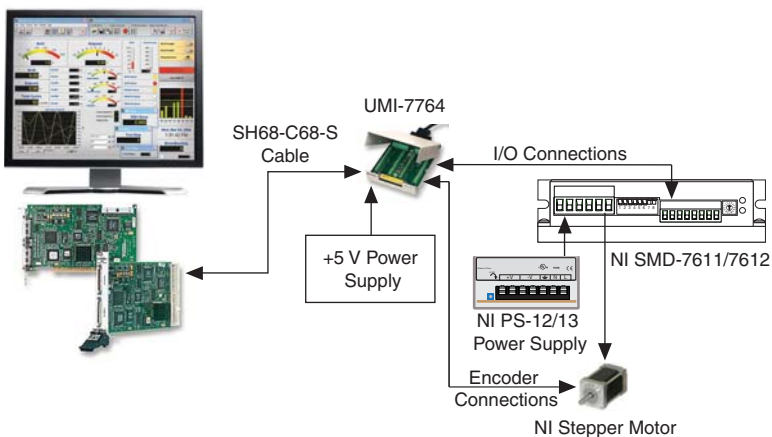

NI Motion Controller Configuration and Installation

This section covers the hardware setup for the NI motion controller.



Caution Before installing the NI 7330/7340/7350 motion controller refer to the user manual appropriate to your controller for safety and specification information. Failure to follow safety instructions may result in damage to equipment.

Step 1: Install NI-Motion

You must install the NI-Motion driver software *before* installing an NI motion controller for the first time. If you are upgrading from a previous version of NI-Motion, it is not necessary to remove the NI motion controller before installing the upgrade. The upgrade does not affect the existing Microsoft Windows configuration.



Note If you are using a Real-Time OS, install LabVIEW Real-Time on the development computer before installing NI-Motion so that the RT support files install.

Complete the following steps to install the NI-Motion driver software:



Note When installing NI-Motion, you must be logged on with administrator-level access. After you have restarted the system, you may need to refresh Measurement & Automation Explorer (MAX) to view the new controller.

1. Insert the NI-Motion CD into the CD-ROM drive to display the NI-Motion installation screen, or download the latest version from ni.com/downloads.
2. If you have autorun enabled, `autorun.exe` runs automatically. Otherwise, double-click `autorun.exe`.
3. Follow the onscreen instructions.



Note You must update the firmware on your NI motion controller(s) before you can use them with the corresponding version of NI-Motion. Refer to [Step 1: Update Firmware on the Motion Controller](#) in the *Software Installation and Configuration* section for detailed instructions.

Step 2: Install the NI 73xx Motion Controller

The following sections explain how to install PXI and PCI motion controllers.

PXI Controllers

1. Power off and unplug the chassis.



Caution To protect yourself and the computer from electrical hazards, the computer *must* remain unplugged until the installation is complete.

2. Choose an unused peripheral slot and remove the filler panel.

3. Touch a metal part on the chassis to discharge any static electricity that might be on your clothes or body. Static electricity can damage the controller.
4. Insert the PXI controller into the chosen slot. Use the injector/ejector handle to fully secure the device into place.
5. Attach the front panel of the PXI controller to the front panel mounting rails of the chassis with the slot screws on the chassis.



Caution Always power on the computer containing the motion controller and initialize the controller before you power on the rest of the motion system. Power off the motion system in the reverse order.

6. Plug in and power on the chassis.

PCI Controllers

1. Power off and unplug the computer.



Caution To protect yourself and the computer from electrical hazards, the computer *must* remain unplugged until the installation is complete.

2. Open the computer case to expose access to the PCI expansion slots.
3. Touch a metal part on the chassis to discharge any static electricity that might be on your clothes or body. Static electricity can damage the controller.
4. Choose an unused +3.3 V or +5 V PCI slot, and remove the corresponding expansion slot cover on the back panel of the computer.
5. Gently rock the controller into the slot. The connection may be tight, but do *not* force the controller into place.



Note Check that the bracket of the device aligns with the hole in the back panel rail of the computer chassis.

6. Secure the mounting bracket of the controller to the back panel rail of the computer.
7. Replace the cover.



Caution Always power on the computer containing the motion controller, and then initialize the controller before you power on the rest of the motion system. Power off the motion system in the reverse order.

8. Plug in and power on the computer.

Step 3: Install Software on and Configure the RT PXI Controller (PXI Motion Controllers Only)



Note This step is only required if you are using a PXI-7330/7340/7350 motion controller and an RT PXI controller. If you are not using an RT PXI controller, skip to the [Step 1: Connect and Configure the NI UMI-7764](#) section.

Complete the following steps to configure the controller and install software on it.



Note The Measurement & Automation Explorer (MAX) user interface may not match these steps exactly depending on which version of MAX you are using.

1. Boot the NI PXI embedded controller into the real-time operating system. The PXI controller automatically boots into LabVIEW RT Safe Mode when no software is installed. LabVIEW RT Safe Mode loads with the basic real-time operating system and automatically attempts to connect to the network using DHCP. If DHCP is not available, the controller connects to the network with a link-local IP address.



Tip You can connect a monitor to the PXI to display startup messages such as the IP address and MAC address.

2. Launch Measurement & Automation Explorer (MAX) on the development computer by clicking the MAX icon on the desktop () , or by selecting **Start»All Programs»National Instruments»Measurement & Automation**.
3. Expand the **Remote Systems** branch. MAX lists the PXI controller as the model name of the controller followed by the MAC address (for example, **NI-PXI-8104 00802f108562**).



Tip Record the PXI controller MAC address, located on the side of the controller, for use in identifying the controller. The label also can be removed and placed on the front of the controller for easier access. If you have connected the PXI controller to a monitor, the MAC address also appears when the PXI system boots up.

4. Select the **System Settings** tab and type a descriptive name for the system in the **Name** field.
5. (Optional) Complete this step only if the target has an empty IP address (0.0.0.0). Select the **Network Settings** tab and select **DHCP or Link Local** from the **Configure IPv4 Address** list to assign an IP address or select **Static** to specify a static IP address in the **IPv4 Address** section.
6. Click **Save** on the toolbar and let MAX reboot the system.
7. When the new system name appears under **Remote Systems**, expand the controller item in the tree, right-click **Software**, and select **Add/Remove Software**.
8. Install the LabVIEW Real-Time software and NI-Motion on the RT target. Go to ni.com/info and enter `etspc` for the latest information about supported software.

9. Click **Next** to install the selected software on the controller. Click **Help** if you need information about installing recommended software sets.
10. Wait for installation to complete, then click **Finish**.
11. Expand the **Devices and Interfaces** item under the PXI system.
12. Right-click the remote motion controller icon and select **Map to Local Machine**. This assigns a local board ID to the remote motion controller in the host system.

Mapping the remote controller into the local system allows you to configure the controller through MAX exactly as you would a controller that is in the host system. You can initialize the controller, download firmware, and use the interactive and configuration panels exactly as you would on a controller installed in the host machine. You also can write VIs using the remote motion controller through the local board ID assigned to it.

This allows you to write and debug your VIs on the host, and then download them to the remote system when you are ready. All you need to change is the board ID in your VI from the locally assigned Board ID to the ID assigned by the remote system.

13. Browse to **Devices and Interfaces** under **My System**, where there is a shortcut icon next to a new controller name.

For example, if the motion controller on the remote system is a PXI-7354, and the remote system has an IP address of 123 . 45 . 678 . 9, then the shortcut device would show a name like **PXI-7354 (X) on 123.45.678.9 (Y)**.

X is the board ID assigned to the board by the remote system. Use this board ID for VIs that are downloaded to the remote system through LabVIEW RT.

Y is the board ID assigned to the remote motion controller by the local system. Use this board ID for any VIs that run on the host and use the remote motion controller.

14. Close MAX.

NI UMI-7764 and NI SMD-7611/7612 Configuration and Installation

This section covers the hardware setup for the NI UMI-7764 and NI SMD-7611/7612 stepper drive. If you are using a UMI-7772/7774 refer to the [Connecting and Using the NI SMD-7611/7612 with the NI UMI-7764](#) section.

Step 1: Connect and Configure the NI UMI-7764

Complete the following steps to connect and configure your UMI-7764.



Tip For more information about connecting external power, encoders, and other motion I/O signals, refer to the *Universal Motion Interface (UMI)-7764 User Guide and Specifications*.

1. Connect the SH68-C68-S 68-pin shielded cable between the Motion I/O connector on the NI 73xx motion controller and the Motion I/O connector on the UMI-7764.

2. Configure the UMI-7764 DIP switches. You must set the DIP switches to the following settings to match the polarity configuration for the SMD-7611/7612 stepper drive:
 - Inhibit Input (S2)—Active Low
 - Inhibit Output (S1)—Active Low

The UMI-7764 DIP switch configuration is shown in Figure 15.

Figure 15. UMI-7764 Inhibit Input and Inhibit Output DIP Switch Settings

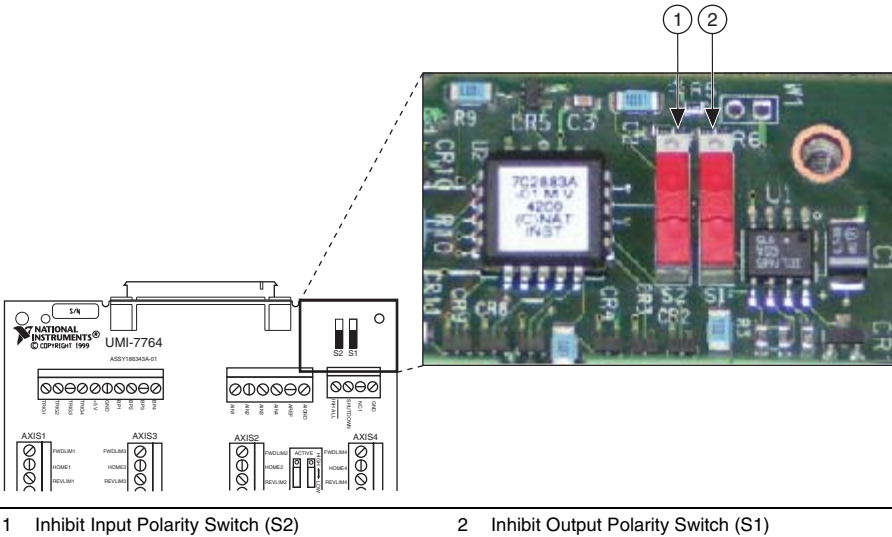

1 Inhibit Input Polarity Switch (S2)

2 Inhibit Output Polarity Switch (S1)

3. Connect an external +5 V power supply to the UMI-7764 Power Input Terminal Block. This connection is required to power the encoder circuitry that converts differential encoder signals to single-ended signals for the motion controller, as well as to power the UMI-7764 Inhibit Output signals.



Caution Do not plug in or turn on any power to the system until after all hardware connections are complete.

Figure 16 shows the location of the UMI 7764 Power Input Terminal Block.

Figure 16. UMI-7764 Power Input Terminal Block

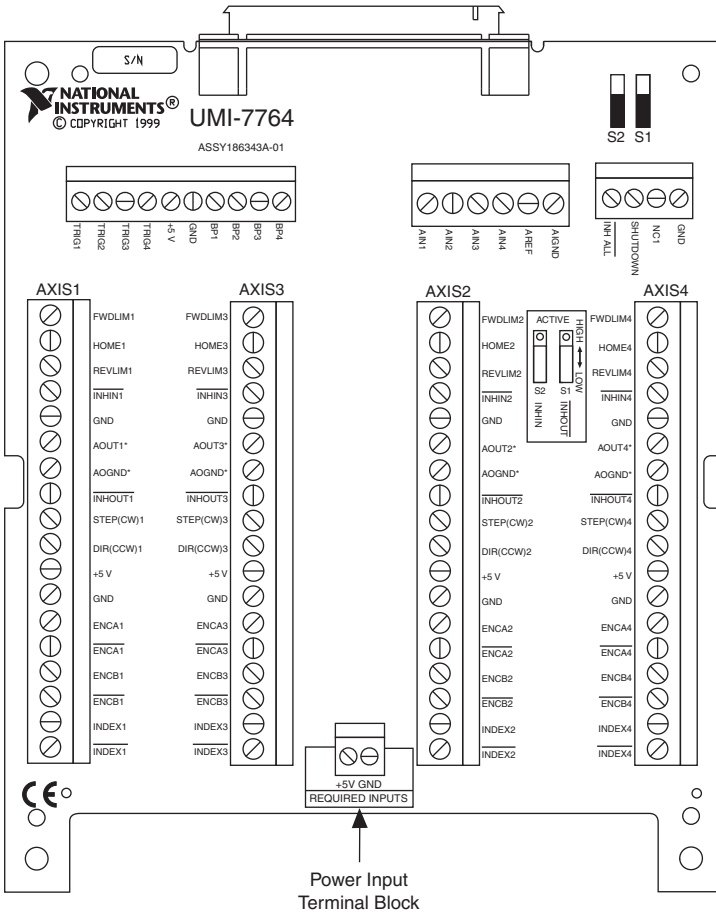

Step 2: Connect the Drive Command Signals to the UMI-7764

Complete the following steps to connect the Drive Command signals to the UMI-7764.

1. Connect the SMD-7611/7612 STEP- terminal to the Motion I/O terminal block STEP (CW)1 terminal.
2. Connect the SMD-7611/7612 DIR- terminal to the Motion I/O terminal block DIR (CCW)1 terminal.
3. Connect the SMD-7611/7612 STEP+ and DIR+ terminals to the Motion I/O terminal block +5V terminal.

Figure 17 shows the SMD-7611/7612 Drive Command and I/O Connector location and pinout.

Figure 17. SMD-7611/7612 Drive Command and I/O Connector

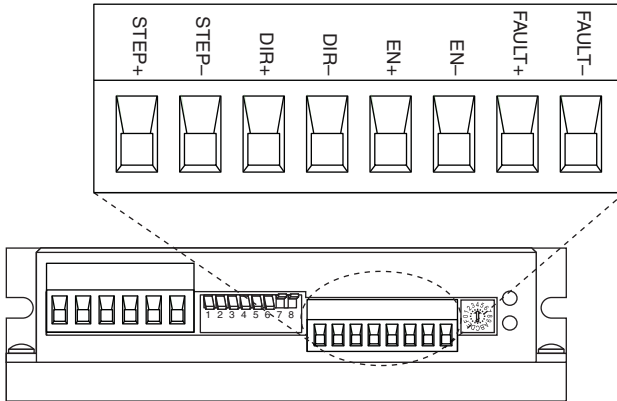
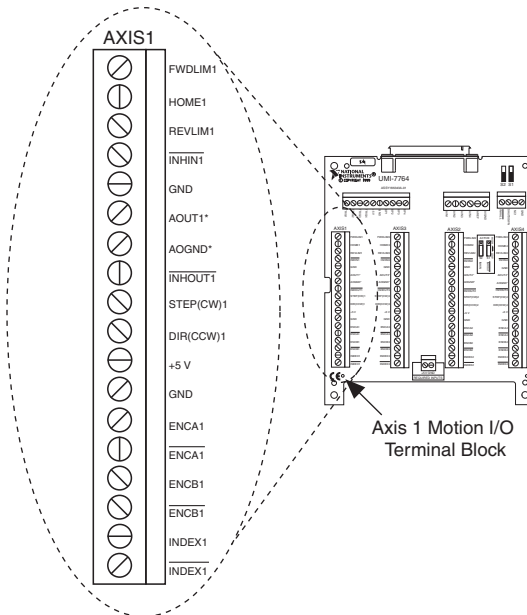

Figure 18 shows the UMI-7764 Motion I/O terminal block location and pinout.

Figure 18. UMI-7764 Motion I/O Terminal Block



Step 3: Connect the Drive Enable Signal to the UMI-7764

Complete the following steps to connect the Drive Enable signal, which controls the enable function of the drive:

1. Connect the EN- terminal to the Motion I/O terminal block $\overline{\text{INHOUTI}}$ terminal.
2. Connect the EN+ terminal to the Motion I/O terminal block +5V terminal.

Step 4: (Optional) Connect the Drive Fault Signal to the UMI-7764

Complete the following optional steps to connect the drive fault signal to monitor the SMD-7611/7612 for faults.

1. Connect the FAULT+ terminal to the Motion I/O terminal block $\overline{\text{INHINI}}$ terminal.
2. Connect the FAULT- terminal to the Motion I/O terminal block GND terminal.

Step 5: (Optional) Connect the Encoder Signals to the UMI-7764

If your motor includes an encoder, connect the encoder signals to the UMI-7764.

1. Connect one end of the encoder cable to the encoder.
2. Cut the 15-pin DSUB connector off of the other end of the cable and expose the encoder wires.
3. Connect the encoder wires to the UM-7764 Motion I/O terminal block as indicated in Table 5.
4. Insulate any unused wires.

Table 5. Encoder to UMI-7764 Motion I/O Terminal Block Connections

Encoder Signal Name	Encoder Cable Wire Color	Motion I/O Terminal Block Signal Name
A	blue	ENCA1
\overline{A}	blue/white	$\overline{\text{ENCAI}}$
B	yellow	ENCB1
\overline{B}	yellow/white	$\overline{\text{ENCB1}}$
I	orange	INDEX1
\overline{I}	orange/white	$\overline{\text{INDEXI}}$
GND	black	GND
+5V	red	+5 V

Step 6: Connect the NI PS-12/13 Power Supply to the NI SMD-7611/7612



Note Do not plug in or turn on the power supply until after you complete [Step 10: Power on the Drive and Verify Connections](#).

Complete the following steps to connect the power supply to AC input power and to the NI SMD-7611/7612. Figure 19 shows the power supply terminals.

Figure 19. NI PS-12/13 Power Supply Terminals

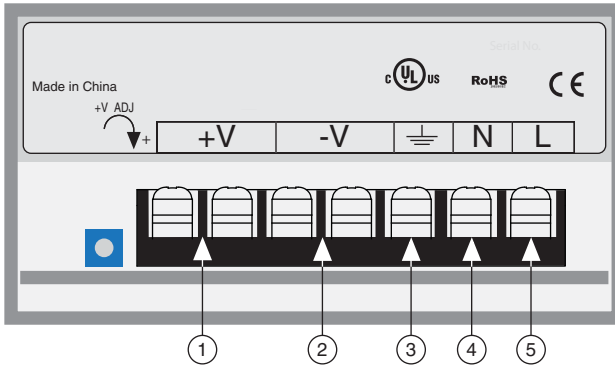

- | | |
|---|--------------------|
| 1 +24 V (NI PS-12) or +48 V (NI PS-13) Output | 4 AC Input Neutral |
| 2 +24 V (NI PS-12) or +48 V (NI PS-13) Ground | 5 AC Input Line |
| 3 AC Input Ground (Protective Earth) | |

Figure 20 shows the SMD-7611/7612 Power and Motor Connector location and pinout.

Figure 20. SMD-7611/7612 Power and Motor Connector

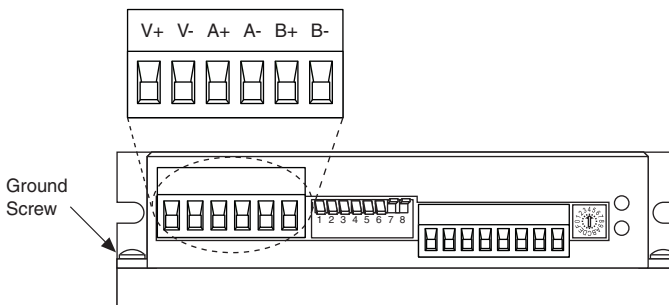

1. Connect an AC input cable to the line, neutral, and protective earth connectors.
2. Connect the SMD-7611/7612 V+ terminal to the power supply +V connector.
3. Connect the SMD-7611/7612 V- terminal to the power supply -V connector.

4. Connect the SMD-7611/7612 green ground screw to earth ground.
5. Connect the NI UMI power supply ground/common terminal and NI PS-12/13 power supply ground connections to ensure a common reference.



Note Refer to the *NI SMD-7611/7612 User Manual* for more information about connecting the power supply.

Step 7: Connect the SMD-7611/7612 to the Motor

NI offers stepper motors matched to the SMD-7611/7612. The ST24-1, ST24-2, and ST24-3 are four lead motors. Connect them as shown in Figure 21.



Note Motor wire colors are correct for NI stepper motors compatible with the NI SMD-7620/7621. These wire colors may not match a third-party stepper motor.

Figure 21. Four Lead Motor Connection

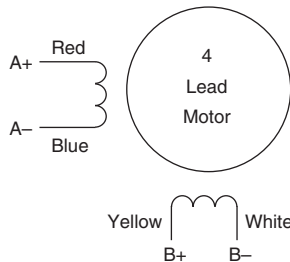

The ST17-1, ST17-2, ST17-3, ST17-4, ST23-1, ST23-4, ST23-6, ST23-8, ST34-4, ST34-8 are eight lead motors that are connected using a parallel configuration. Connect them as shown in Figure 22.

Figure 22. Eight Lead Motor Parallel Connection

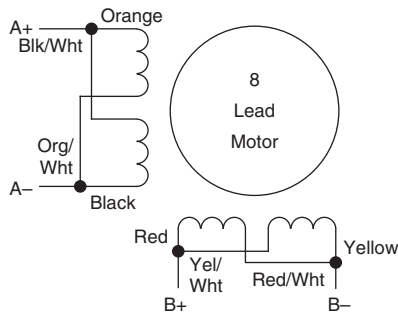

When using the SMD-7612, connect the ST34-1, ST34-2, and ST34-5 using a parallel configuration as shown in Figure 22.

When using the SMD-7611, connect the ST34-1, ST34-2, and ST34-5 using a series configuration as shown in Figure 23.

Figure 23. Eight Lead Motor Series Connection

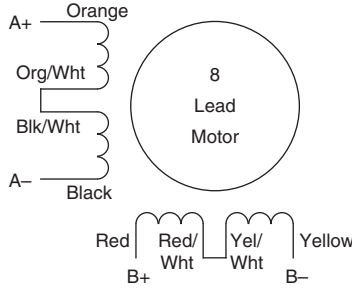

Step 8: Set the Motor Selection Switch

National Instruments offers stepper motors matched to the NI SMD-7611/7612. National Instruments highly recommends using these motors for the best user experience. Figure 24 shows the Motor Selection Switch location.

Figure 24. NI SMD-7611/7612 Motor Selection Switch

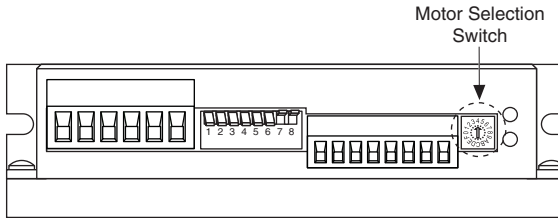

Tables 6 and 7 show the switch settings for compatible stepper motors for the SMD-7611 and SMD-7612, respectively. If you are not using a motor in the list, set the switch to a motor with a rotor inertia, holding torque, and current that are within 10% of your motor.

Table 6. NI SMD-7611 Motor Selection Switch Settings

Switch Setting	Motor	Wiring	Drive Current Amps, peak of sine	Holding Torque, (oz.-in)	Rotor Inertia (g-cm ²)
0	reserved for custom configurations				
1					
2	ST17-4	parallel	2.4	113	123
3	ST17-1	parallel	1.6	31.4	35
4	ST17-2	parallel	2	51	54

Table 6. NI SMD-7611 Motor Selection Switch Settings (Continued)

Switch Setting	Motor	Wiring	Drive Current Amps, peak of sine	Holding Torque, (oz.-in)	Rotor Inertia (g-cm ²)
5	ST17-3	parallel	2	62.8	68
6	ST23-1	parallel	3.4	76.6	120
7	ST23-4	parallel	4.5	159.3	300
8	ST23-6	parallel	4.5	237.6	480
9	ST24-1	4 leads	3.36	123	280
A	ST24-2	4 leads	4.5	166	450
B	ST24-3	4 leads	4.5	332	900
C	ST34-2	series	4.5	585	1400
D	ST34-5	series	4.5	1113	2680
E	ST34-1	series	3.816	396	1100

Table 7. NI SMD-7612 Motor Selection Switch Settings

Switch Setting	Motor	Wiring	Drive Current Amps, peak of sine	Holding Torque, (oz.-in)	Rotor Inertia (g-cm ²)
0	reserved for custom configurations				
1					
2					
3	ST23-8	parallel	6	354	750
4	ST23-1	parallel	3.4	76.6	120
5	ST23-4	parallel	5	177	300
6	ST23-6	parallel	5	264	480
7	ST24-1	4 leads	3.36	123	280
8	ST24-2	4 leads	4.8	177	450
9	ST24-3	4 leads	4.8	354	900
A	ST34-2	parallel	8	507	1400
B	ST34-5	parallel	8	965	2680

Table 7. NI SMD-7612 Motor Selection Switch Settings (Continued)

Switch Setting	Motor	Wiring	Drive Current Amps, peak of sine	Holding Torque, (oz.-in)	Rotor Inertia (g-cm ²)
C	ST34-8	parallel	8	1439	4000
D	ST34-1	parallel	7.56	396	1100
E	ST34-4	parallel	7.56	849	1850

Step 9: Configure the NI SMD-7611/7612 DIP Switches

The NI SMD-7611/7612 provides drive configuration DIP switches. Refer to the *NI SMD-7611/7612 User Manual* for more information about the DIP switch options. The following figure shows the DIP switch location and functions.



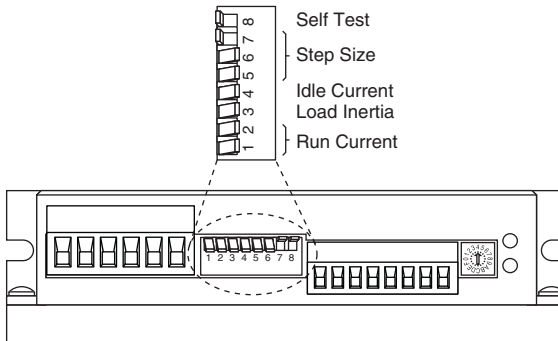

Note If you change the DIP switch settings you must power cycle the NI SMD-7611/7612 for the new settings to take effect.

Figure 25. NI SMD-7611/7612 DIP Switches

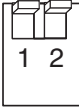
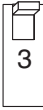

Refer to Table 8 for the DIP switch settings that this document uses.

Table 8. DIP Switch Settings

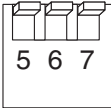
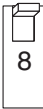
Setting Name	Switch Position	Corresponding Value
Running Current		100%
Load Inertia		0 - 4X
Idle Current		50%
Steps/rev		20000
Self Test		Off

Step 10: Power on the Drive and Verify Connections

After all hardware connections have been made complete the following steps to confirm the hardware setup.

1. Turn on all power supplies.
2. Verify that the Drive Status LED on the NI SMD-7611/7612 flashes or is solid green. Figure 26 shows the location of the Drive Status LED.

Figure 26. Drive Status LED Location

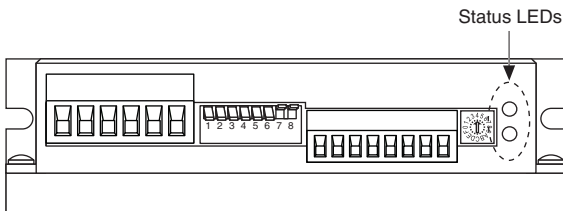

If the Drive Status LED does not flash or turn solid green, turn off all power, verify the connections, and try again. Refer to the [Worldwide Support and Services](#) section for additional tips.



Software Installation and Configuration

This section covers installing and configuring the software for the NI 7330/7340/7350 motion controller.

Step 1: Update Firmware on the Motion Controller

Firmware is software that is loaded onto the motion controller. Firmware allows you to update the motion controller with new features and updates. The latest firmware is automatically installed on the computer when you install the latest version of NI-Motion. You must download the firmware to the motion controller.

Complete the following steps to download firmware to an NI motion controller:

1. Click the MAX icon on the desktop () , or select **Start»All Programs»National Instruments»Measurement & Automation** to open MAX.
2. Expand **Devices and Interfaces**, and then expand **NI Motion Devices** in the configuration tree.
3. Select the motion controller for which you want to download firmware. An exclamation point on the NI 7330/7340/7350 motion controller icon () indicates that the firmware is outdated and must be updated.
4. Click the **Firmware** tab at the bottom of the window. An exclamation point appears for each firmware sector that requires an update.
5. Click the **Update Firmware** button at the top of the window to update all the firmware files on your device.

Step 2: Configure the NI Motion Controller

Complete the following steps to configure the NI 7330/7340/7350 motion controller for use with the SMD-7611/7612.

1. Open MAX, if it is not already open.
2. Expand **Devices and Interfaces**, expand **NI Motion Devices**, and then select the appropriate motion controller in the configuration tree.
3. Expand the NI motion controller configuration tree item and click **Default xxxx Settings**.
4. Select **Open Loop Stepper** from the **Default Configurations** section.
5. Expand **Default xxxx Settings**, and then expand the axis associated with the NI SMD-7611/7612 stepper drive.
6. Click **Axis Configuration** and set **Type** to **Stepper**.
7. Click the **Stepper Settings** tab on the bottom of the window and set **Stepper steps per revolution** to 20,000.



Note The **Stepper steps per revolution** setting *must* match the Steps/rev DIP switch setting on the NI SMD-7611/7612. If you change the Steps/rev setting using the DIP switches, update this setting to match.

- Click **Motion I/O Settings** and select **Disabled** for the **Forward Limit Switch**, **Reverse Limit Switch**, and **Home Switch**.



Note These configuration settings disable limits for initial setup and testing purposes. National Instruments recommends connecting and enabling limits in your final application.

- Set the limit and home input active state depending on which NI UMI you are using. This prevents the limit active error from occurring when no limits are connected.
 - UMI-7772/7774—**Active High Polarity**
 - UMI-7764—**Active Low Polarity**
- Set **Inhibit Output Settings** to **Active Low Polarity**.
- (Optional) Click **Encoder Settings**.
 - In the **Polarities** section confirm that the **Line State** for **A**, **B**, and **Index** is set to **Active High**.
 - In the **Index Reference Criteria** section confirm that the **Line State** for **A** and **B** is set to **Inactive**.
 - Set Encoder counts per revolution to 8,000. This setting is the encoder resolution in quadrature counts per revolution and corresponds to the encoder lines per revolution multiplied by four.
- Click **Initialize** on the toolbar to send the updated settings to the motion controller. Initializing the motion controller resets it to a known starting state so that it is ready for commands.

Step 3: Test the Motor In MAX

You will now move the motor using the NI motion controller and MAX. Select the **1-D Interactive** panel in the Configuration tree and change the settings to match those shown in Figure 27. Change the axis if you are not using Axis 1.

Figure 27. 1-D Interactive Panel Settings

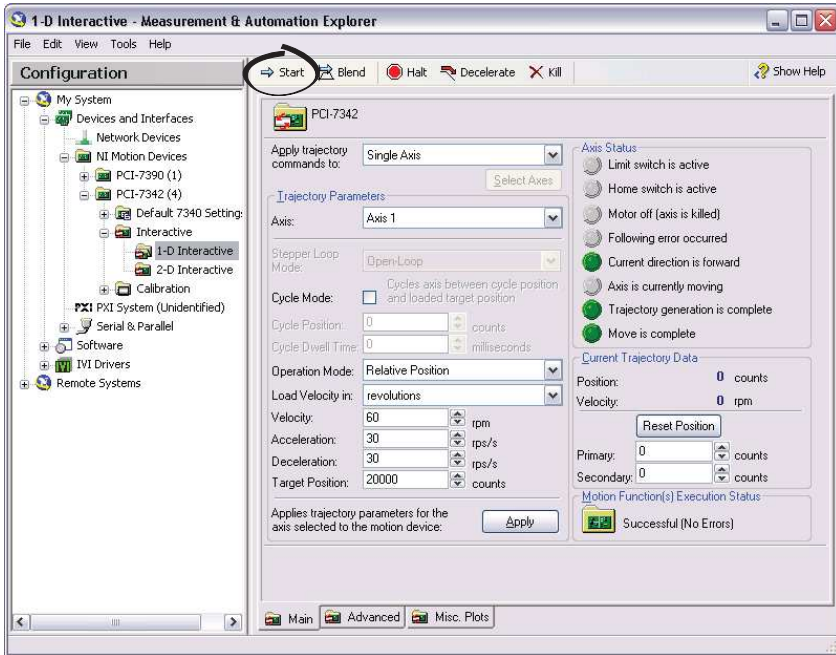

13. Click **Start**. Your motor should rotate 1 revolution at 60 rpm.
14. Finalize your motion system setup by connecting and configuring additional I/O such as limits as required by your application.
 - If using the UMI-7764, use the available screw-terminal connections on the same axis terminal block as the integrated steppers connections.
 - If using the UMI-7772/7774, use the DB9M, DB15M, and DB25M pigtail cables.

Where to Go Next

The following documents contain additional information that you may find helpful. All referenced documents ship with the product and are available at ni.com/manuals.

- *NI 7330 User Manual, NI 7340 User Manual, or NI 7350 User Manual*—Describes the electrical and mechanical aspects of the NI 7330/7340/7350 motion controller, and contains information about installing and operating the device.
- *Getting Started with NI-Motion for NI 73xx Motion Controllers*—Provides instructions for installing and getting started with the NI-Motion driver software and NI motion controllers.
- *NI SMD-7611/7612 User Manual*
- *NI-Motion Help*—Contains information about designing a basic move, designing a multi-axis move, incorporating image and data acquisition into motion applications, and working with common motion concepts, such as contouring and breakpoints. This document is task-based and takes you through each phase of designing and executing a motion application.
- *NI-Motion Function Help*—Contains function reference information for C and Visual Basic and provides details about each function, including a description of the function, a list of the function parameters, illustrations, and error codes.
- *NI-Motion VI Help*—Contains LabVIEW VI reference information and provides details about each VI, including VI descriptions, lists of VI parameters, usage, illustrations, and error codes.
- *Measurement & Automation Explorer Help for Motion*—Provides information about using MAX to configure the NI motion controller as well as advanced conceptual information about topics such as Bode analysis and control loop parameters.
- *Getting Started with LabVIEW*—Use this document as a tutorial to familiarize yourself with the LabVIEW graphical programming environment and the basic LabVIEW features you use to build data acquisition and instrument control applications. Access the *Getting Started with LabVIEW* PDF by selecting **Start»All Programs»National Instruments»LabVIEW»LabVIEW Manuals»LV_Getting_Started.pdf**.

Worldwide Support and Services

The National Instruments Web site is your complete resource for technical support. At ni.com/support you have access to everything from troubleshooting and application development self-help resources to email and phone assistance from NI Application Engineers.

Visit ni.com/services for NI Factory Installation Services, repairs, extended warranty, calibration, and other services.

Visit ni.com/register to register your National Instruments product. Product registration facilitates technical support and ensures that you receive important information updates from NI.

A Declaration of Conformity (DoC) is our claim of compliance with the Council of the European Communities using the manufacturer's declaration of conformity. This system affords the user protection for electromagnetic compatibility (EMC) and product safety. You can obtain the DoC for your product by visiting ni.com/certification. If your product supports calibration, you can obtain the calibration certificate for your product at ni.com/calibration.

National Instruments corporate headquarters is located at 11500 North Mopac Expressway, Austin, Texas, 78759-3504. National Instruments also has offices located around the world to help address your support needs. For telephone support in the United States, create your service request at ni.com/support and follow the calling instructions or dial 512 795 8248. For telephone support outside the United States, visit the Worldwide Offices section of ni.com/niglobal to access the branch office Web sites, which provide up-to-date contact information, support phone numbers, email addresses, and current events.

Refer to the *NI Trademarks and Logo Guidelines* at ni.com/trademarks for more information on National Instruments trademarks. Other product and company names mentioned herein are trademarks or trade names of their respective companies. For patents covering National Instruments products/technology, refer to the appropriate location: **Help»Patents** in your software, the `patents.txt` file on your media, or the *National Instruments Patents Notice* at ni.com/patents. You can find information about end-user license agreements (EULAs) and third-party legal notices in the readme file for your NI product. Refer to the *Export Compliance Information* at ni.com/legal/export-compliance for the National Instruments global trade compliance policy and how to obtain relevant HTS codes, ECCNs, and other import/export data.