

COMPREHENSIVE SERVICES

We offer competitive repair and calibration services, as well as easily accessible documentation and free downloadable resources.

SELL YOUR SURPLUS

We buy new, used, decommissioned, and surplus parts from every NI series. We work out the best solution to suit your individual needs.

 Sell For Cash  Get Credit  Receive a Trade-In Deal

OBSOLETE NI HARDWARE IN STOCK & READY TO SHIP

We stock **New, New Surplus, Refurbished, and Reconditioned** NI Hardware.



Bridging the gap between the manufacturer and your legacy test system.

 1-800-915-6216

 www.apexwaves.com

 sales@apexwaves.com

All trademarks, brands, and brand names are the property of their respective owners.

Request a Quote

 **CLICK HERE**

UMI-7764

GETTING STARTED

NI 7330/7340/7350 Motion Controllers and P7000 Series Stepper Drives

This manual helps you quickly install and configure the P7000 series stepper drives and stepper motors for use with NI 7330, NI 7340, and NI 7350 motion controllers. It assumes you have already installed your National Instruments motion controller and driver software. The driver CD installs the NI Measurement & Automation Explorer (MAX) configuration files and documents referenced in this manual. You can find all the software, files, and documents at ni.com/motion/stepper.

Additionally, this manual assumes you are using either the NI Universal Motion Interface (UMI)-7764 or NI UMI-7774/7772 and have the appropriate 68-pin cable for connecting to your NI motion controller. Refer to the *NI Stepper Motion System Selection Guide* at ni.com/motion/stepper for assistance. For specifications or installation questions about your NI motion controller or NI UMI, refer to the appropriate user manual.

Contents

What You Need to Get Started	1
Hardware.....	1
Software.....	2
Related Documentation.....	3
Configuration and Installation	4
Step 1: Connecting the Stepper Motor to the Drive.....	4
Step 2: Configuring the DIP Switches.....	5
Step 3: Connecting Power to the P7000 Drive	13
Step 4: Configuring the P7000 Drive with the Serial Port (Optional).....	15
Step 5: Installing the P7000 Tools (Optional)	16
Step 6: Testing the Motor With the P7000 Tools (Optional)	20
Step 7: Configuring the NI UMI.....	20
Step 8: Configuring Your NI Motion Controller Using Measurement & Automation Explorer (MAX)	22
Step 9: Testing the Motor Using MAX	26
Configuring Moves with NI Motion Assistant (Optional).....	26
Exporting to LabVIEW.....	27
Troubleshooting the P7000 Series Stepper Drive.....	28
Where to Go for Support	28

What You Need to Get Started

You need the following items to get started.

Hardware

- NI 7330/7340/7350 motion controller
- NI UMI-7764 or NI UMI-7774/7772

- Power supply for the NI UMI:
 - +5 V if using the UMI-7764
 - +24 V if using the UMI-7774/7772
- 68-pin cable to connect your NI UMI and motion controller
- P70360 or P70530 stepper drive
- P7000 direct connect cable appropriate for the NI UMI you are using
- DC power supply if using the P70530 stepper drive
- NI or third-party stepper motor
- NI or third-party encoder (optional)
- RS-232 serial communication cable for P7000 drives (optional)

Software

- NI-Motion 7.6 or later driver software
- One of the following software packages and documentation:
 - LabVIEW 7.1.1 or later
 - LabWindows™/CVI™ 7.0 or later
 - Microsoft Visual C++ 6.0 or later
 - Microsoft Visual Basic 6.0 or later
- NI Motion Assistant 2.2 or later (optional)
- P7000 Tools configuration software (optional)



Note The RS-232 serial configuration cable and P7000 Tools configuration software are required only if you are using a third-party motor. If you are using an NI stepper motor, you can perform configuration using only the DIP switches on the drive.

Figures 1 and 2 shows the required hardware connections when using the P7000 Series stepper drives with the UMI-7764 and UMI-7772/74 respectively.

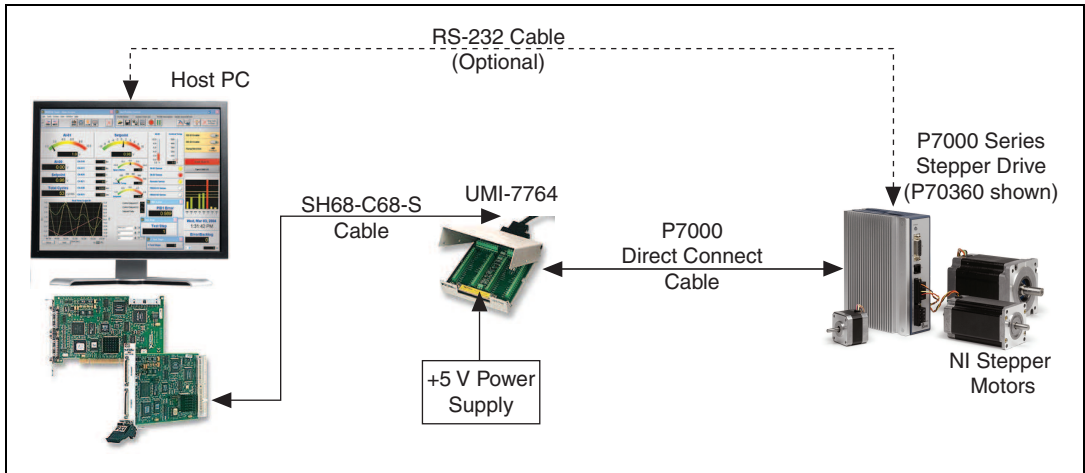

Figure 1. NI 73xx Motion Controller and UMI-7764 Hardware Connections to P7000 Drive

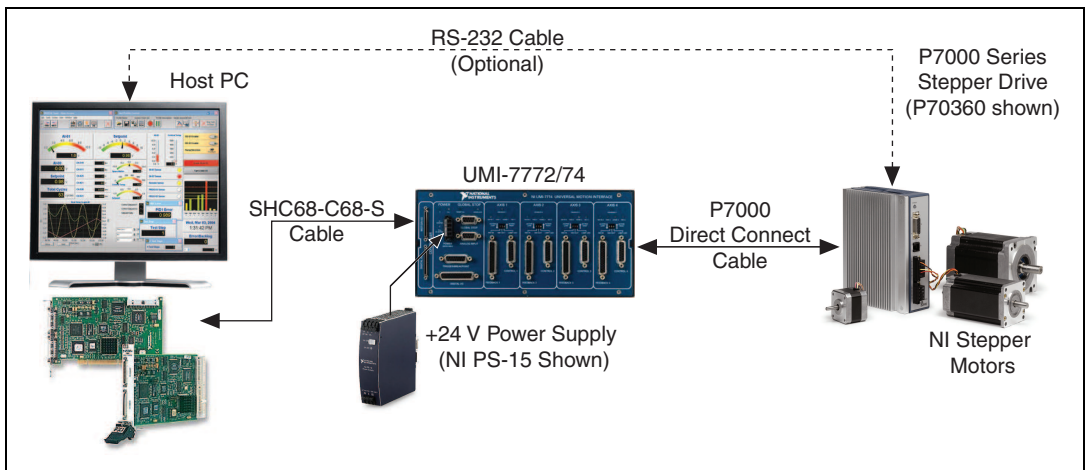

Figure 2. NI 73xx Motion Controller and UMI-7772/74 Hardware Connections to P7000 Drive

Related Documentation

The following documents contain additional information that you may find helpful. All referenced documents ship with the product and are available at ni.com/manuals.

- *NI 7330 User Manual*, *NI 7340 User Manual*, or *NI 7350 User Manual*—Describes the electrical and mechanical aspects of the NI 73xx motion controller, and contains information about installing and operating the device.
- *Getting Started with NI-Motion for NI 73xx Motion Controllers*—Provides instructions for installing and getting started with the NI-Motion driver software and NI PXI/PCI-73xx motion controllers.

- *P70360 (AC) High Performance Micro-stepping Drive Reference Guide*—Provides additional information about the electrical and mechanical aspects of the P70360 AC stepper drive, including important safety information.
- *P70530 (DC) High Performance Micro-stepping Drive Reference Guide*—Provides additional information about the electrical and mechanical aspects of the P70530 DC stepper drive, including important safety information.
- *NI-Motion Help*—Contains information about selecting a motor, designing a basic move, designing a multi-axis move, incorporating image and data acquisition into motion applications, and working with common motion concepts, such as contouring and breakpoints. This document is task-based and takes you through each phase of designing and executing a motion application.
- *NI-Motion Function Help*—Contains function reference information for C and Visual Basic and provides details about each function, including a description of the function, a list of the function parameters, illustrations, and error codes.
- *NI-Motion VI Help*—Contains LabVIEW VI reference information and provides details about each VI, including VI descriptions, lists of VI parameters, usage, illustrations, and error codes.
- *Measurement & Automation Explorer Help for Motion*—Provides information about using MAX to configure the NI 73xx motion controller as well as advanced conceptual information about topics such as Bode analysis and control loop parameters.

Configuration and Installation

You can configure the P7000 series stepper drives using the external DIP switches or with software through the RS-232 port. If you have an NI stepper motor, you can configure the drive and motor using only the DIP switches. If you have a third-party motor, you must use the P7000 Tools configuration software.

Complete the following steps to configure your stepper drive and motor:

Step 1: Connecting the Stepper Motor to the Drive

Connect the stepper motor as shown in Figure 3. The NI stepper motors are highly recommended, as they are optimized to work with the P7000 series stepper drives.



Caution Do *not* hot-plug the motor connector. Also, avoid “whiskers” from stranded phase leads protruding from the motor plug.

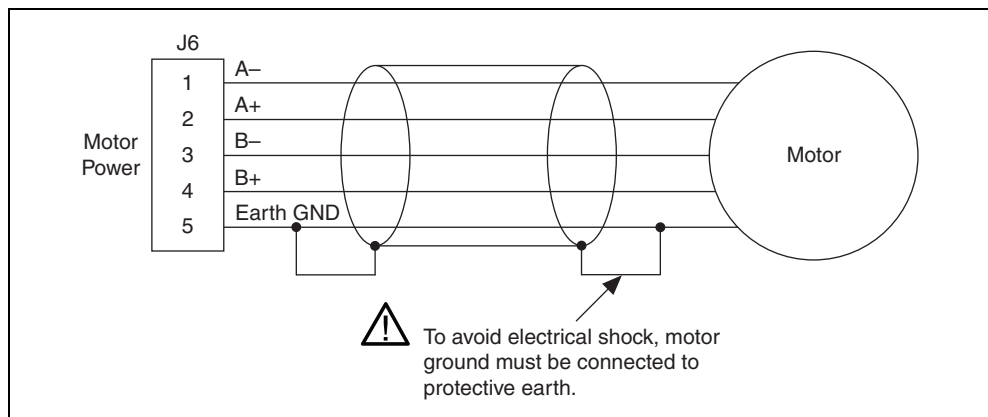

Figure 3. Connecting the Stepper Motor

The NI stepper motor wire color code is shown in Table 1.

Table 1. NI Stepper Motor Wire Colors

Phase	Color
A-	Orange
A+	Black
B-	Yellow
B+	Red
PE	Green/Yellow Stripe



Note To reverse the motor rotation direction, do one of the following:

- Switch A- with A+
- Switch B- with B+
- Switch A-, A+ with B-, B+

National Instruments offers several standard stepper motors that provide optimum performance when matched with the P7000 series stepper drive. The motors have a four flying lead configuration. If your motor has six or eight leads, consult your distributor or the factory for assistance.

Step 2: Configuring the DIP Switches

Configure the DIP switches as follows for proper operation of your P7000 series stepper drive.

Figure 4 shows switches S2-1 through S2-12 in the OFF position for the P70360 drive.

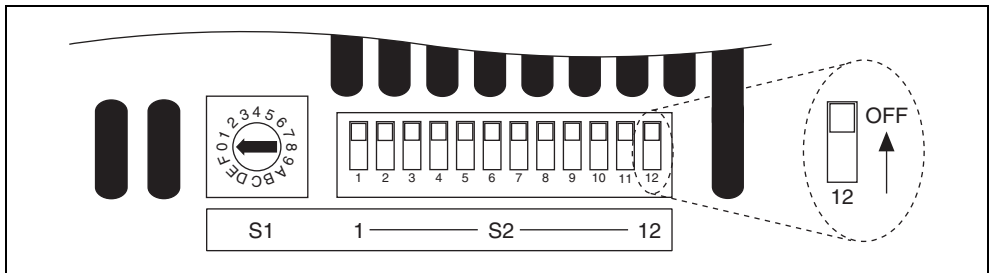

Figure 4. DIP Switches in OFF Position for P70360 Drive

Figure 5 shows switches S2–1 through S2–12 in the OFF position for the P70530 drive.

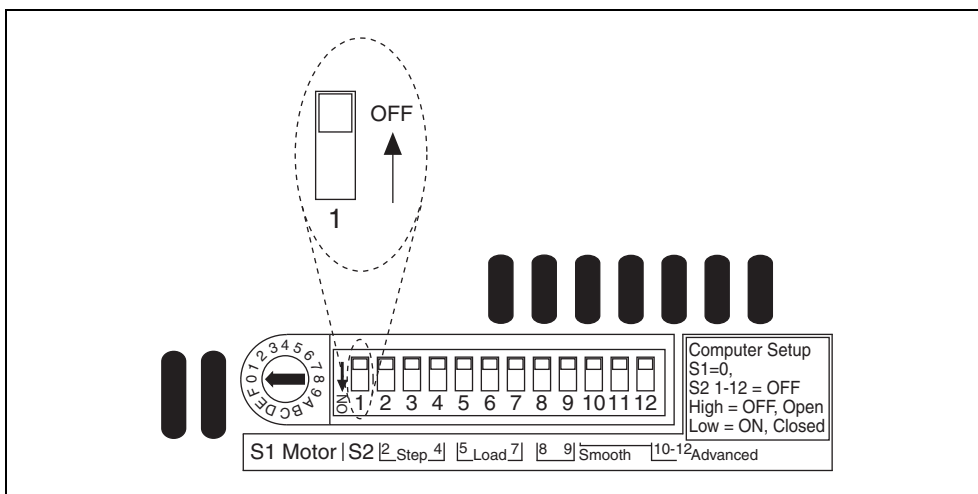

Figure 5. DIP Switches in OFF Position for P70530 Drive

Using Table 4 or 5, set switches S1 and S2-1 to configure the drive for your motor, or use the serial configuration using P7000 Tools if you are using a third-party motor.

For the remaining DIP switches, refer to Tables 2 and 3.



Note For DIP switch settings to take effect, you must power cycle the P7000 series stepper drive whenever you make changes.

Table 2. DIP Switch Positions











Motor Selection			Step Resolution				
S1		S2–1		S2–2	S2–3	S2–4	
Motor Dependent		Motor Dependent		ON 	OFF 	ON 	
Load Inertia			Dynamic Smoothing		Current Reduction	Multi-stepping	Encoderless Stall Detection
S2–5	S2–6	S2–7	S2–8	S2–9	S2–10	S2–11	S2–12
OFF 	OFF 	OFF 	OFF 	OFF 	OFF 	OFF 	OFF 

Table 3. Drive Settings

Drive Option	Setting
Motor selection	Motor dependent (refer to Tables 4 and 5 for switch positions)
Step resolution	5,000 (refer to Table 6 for switch positions)
Load inertia	0–1 (refer to Table 7 for switch positions)
Dynamic smoothing	Minimal (refer to Table 8 for switch positions)
Current reduction	Enabled (refer to Table 9 for switch positions)
Multisteping	Disabled (refer to Table 10 for switch positions)
Encoderless stall detection	Disabled (refer to Table 11 for switch positions)

Motor Selection

Table 4 lists the switch settings for AC P70360-compatible motors. Table 5 lists the switch settings for DC P70530-compatible motors.

Table 4. P70360-Compatible Motor DIP Switch Settings







Motor Frame	Motor	S1	S2–1
NI NEMA 23	T21NRLC	1 	OFF 
	T22NRLC	2 	OFF 
	T23NRLC	3 	OFF 

Table 4. P70360-Compatible Motor DIP Switch Settings (Continued)









Motor Frame	Motor	S1	S2-1
NI NEMA 34	N31HRLG	4 	OFF 
	N32HRLG	5 	OFF 
	N33HRLG	6 	OFF 
Third-party	Serial configuration using P7000 Tools	0 	OFF 

Table 5. P70530-Compatible Motor DIP Switch Settings





















Motor Frame	Motor	S1	S2-1
NI NEMA 17	CTP 10 ELF 10	D 	ON 
	CTP 11 ELF 11	E 	ON 
	CTP 12 ELF 10	F 	ON 
NI NEMA 23	T21NRLH	2 	OFF 
	T22NRLG	3 	OFF 
	T23NRLH	4 	OFF 

Table 5. P70530-Compatible Motor DIP Switch Settings (Continued)

Motor Frame	Motor	S1	S2-1
NI NEMA 34	N31HRHJ	1 	ON 
	N32HRHJ	2 	ON 
	N33HRHJ	3 	ON 
Third-party	Serial configuration using P7000 Tools	0 	OFF 

Step Resolution

Table 6 lists the step resolution switch settings.

Table 6. Step Resolution DIP Switch Settings

























Resolution	S2-2	S2-3	S2-4
200 (Full Step)	ON 	ON 	ON 
400 (Half Step)	OFF 	ON 	ON 
5,000	ON 	OFF 	ON 
10,000	OFF 	OFF 	ON 
18,000	ON 	ON 	OFF 

Table 6. Step Resolution DIP Switch Settings (Continued)

Resolution	S2-2	S2-3	S2-4
25,000	OFF 	OFF 	OFF 
25,400	OFF 	ON 	OFF 
50,000	ON 	OFF 	OFF 

Load Inertia

The P7000 series stepper drives eliminate the resonance typical of step motors with high-speed, digital processing of motor electrical activity. To use this feature, you must set three switches based on the load-to-rotor inertia ratio. These switches select the gain parameter the drive uses to stabilize the motor. You can calculate the load inertia by hand or by using the Motioneering sizing software. If you do not know your inertia ratio, set the DIP switches to OFF for a load-to-rotor inertia ratio of 0–1.

Table 7 lists the load inertia switch settings.

Table 7. Load Inertia DIP Switch Settings

























Load-to-Rotor Inertia Ratio	S2-5	S2-6	S2-7
0–1	OFF 	OFF 	OFF 
1–1.5	ON 	OFF 	OFF 
1.5–2.5	OFF 	ON 	OFF 
2.5–5.0	ON 	ON 	OFF 
5.0–7.0	OFF 	OFF 	ON 

Table 7. Load Inertia DIP Switch Settings (Continued)

Load-to-Rotor Inertia Ratio	S2-5	S2-6	S2-7
7.0–12.0	ON 	OFF 	ON 
12.0–20.0	OFF 	ON 	ON 
20.0–32.0	ON 	ON 	ON 









Dynamic Smoothing

Dynamic smoothing is a temporal filter (second-order, low-pass) applied to the command sequence to reduce jerk. It helps reduce overshoot and lessens the excitation of mechanical resonance in the system. It filters from slightly below the resonant frequency up to well above resonance to remove spectral content that would be misrepresented in the motor output and may also excite other parts of the machine.

Dynamic smoothing is a very powerful feature for achieving maximum torque from the motor. However, it is difficult to optimize and is not necessary for the vast majority of applications. Therefore, National Instruments recommends setting both DIP switches to OFF for minimal smoothing.

Table 8 lists the dynamic smoothing switch settings.

Table 8. Dynamic Smoothing DIP Switch Settings

Dynamic Smoothing	S2-8	S2-9
Minimal	OFF 	OFF 
Moderate	ON 	OFF 
Heavy	OFF 	ON 
Aggressive	ON 	ON 

Current Reduction

Current reduction reduces drive and motor heating by invoking standby current reduction. When enabled, current reduction cuts motor current to 75 percent of its commanded value 100 ms after receipt of the last step pulse. You can adjust the reduction proportion and delay to other values using the P7000 Tools configuration software.



When current reduction is enabled, the motor holding torque is reduced. Do not enable it for applications that require full holding torque when the motor is stationary.

Table 9 lists the current reduction DIP switch settings.



Note Current reduction is *enabled* when switch S2-10 is OFF.

Table 9. Current Reduction DIP Switch Settings



Current Reduction	S2-10
Enabled	OFF 
Disabled	ON 

Multisteping

Multisteping is similar to dynamic smoothing, except it is a much more aggressive use of the filter. Typically, it results in a filter that begins to roll off two octaves below the resonant frequency. This is intended for use with coarse resolution (full/half-step input pulses) to smooth large steps into a continuous train of microsteps, and may provide smoother motion depending on your motion application. Disable multisteping if you are not using full or half step resolution.

Table 10 lists the multisteping switch settings.

Table 10. Multisteping DIP Switch Settings



Multisteping	S2-11
Enabled	ON 
Disabled	OFF 

Encoderless Stall Detection

The P7000 series stepper drive is uniquely designed to sense the motor shaft position at all times. The drive monitors the commanded position and compares it to the actual position. As with any two-phase step motor, when the shaft position and commanded position are greater than two full steps apart, a stall is detected, and the drive faults.

Table 11 lists the encoderless stall detection switch settings.

Table 11. Encoderless Stall Detection DIP Switch Settings

Encoderless Stall Detection	S2-12
Enabled	ON 
Disabled	OFF 

Encoderless stall detection uses an internal motor model for stall detection. Motors listed in Tables 4 and 5 work well with encoderless stall detection. Third-party motors may not work as well, as the algorithm is subject to constraints. National Instruments makes no guarantees of reliability of this feature when using third-party motors.

Step 3: Connecting Power to the P7000 Drive

Connect either AC or DC input power to your P7000 series stepper drive. If you are using the P70360 drive, connect AC power as shown in Figure 6. Refer to Table 12 for DC power connector pin descriptions. If you are using the P70530 drive, connect DC power as shown in Figure 7. Refer to Table 13 for DC power connector pin descriptions.

Connecting AC Power to the P70360



Caution Do *not* use J7 as an on/off switch. Hot plugging damages the connector.

Table 12. J7 AC Power for 320 VDC Bus

Pin	Description
J7-1	120/230 VAC line
J7-2	230 VAC neutral
J7-3	120 VAC neutral
J7-4	PE (Protective Earth)

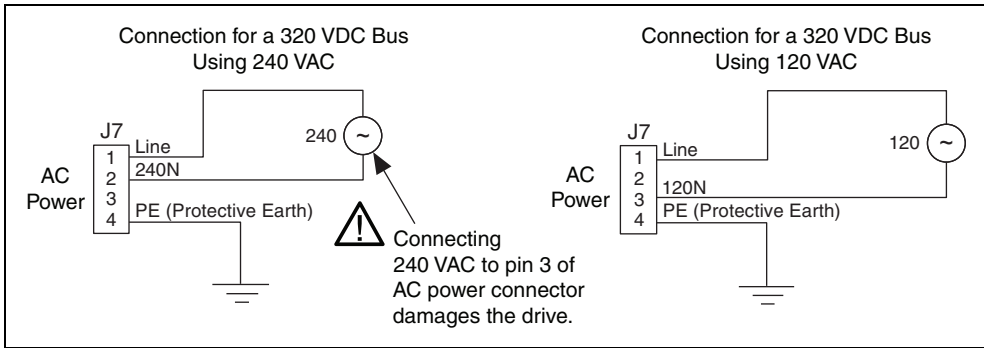

Figure 6. 320 VDC Bus Connection

Refer to the *P70360 (AC) High Performance Micro-stepping Drive Reference Guide*, available from ni.com/manuals or from the Product Support Package CD in your kit, for 160 VDC bus connection. This configuration is required for third-party motors with 7 to 30 mH inductance.

Connecting DC Power

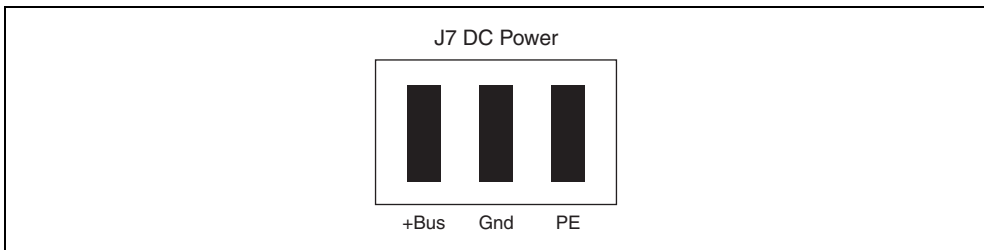

Figure 7. DC Power Connector

Table 13. J7 DC Power

Pin	Description	
J7-1 (+Bus)	Plus power supply terminal	20 to 75 V
J7-2 (Gnd)	Negative power supply terminal Negative power supply terminal/Bus Gnd is normally earthed Maximum allowable voltage between Bus Gnd (J7-2) and Chassis (J7-3) is 100 V peak	5 A max Isolated, unregulated (or regulated) power supply
J7-3 (PE)	Connect to PE (Protective Earth) J7-3 connects to J6-5 inside drive (shield)	



Note National Instruments recommends using insulated wire ferrules to prevent shorting and add strain relief.

Power on your DC or AC power supply. Once powered, the P7000 drive enters a configuration mode that causes the LED to flash and the motor to audibly squeal. This is expected operation, as the drive is measuring the motor windings to optimize its settings. Once complete, the status LED should illuminate green. If it is not, refer to the [Troubleshooting the P7000 Series Stepper Drive](#) section.



Note The following step is required only if you are using the P7000 Tools configuration software and configuring the drive with the RS-232 port. If you are using an NI stepper motor, you can configure the drive with the DIP switches only and proceed to [Step 7: Configuring the NI UMI](#) to configure the NI UMI.

Step 4: Configuring the P7000 Drive with the Serial Port (Optional)

1. Connect the RS-232 serial communication cable between the drive and computer COM1 port.
You must set the COM1 port to the following settings:
 - Baud Rate: 19,200
 - Data Bits: 8
 - Parity: Even
 - Stop Bits: 1
 - Flow Control: None
2. Configure a COM port to be used with the serial cable. To change your COM port, open the Device Manager, click **Ports (COM & LPT)**, and double-click the desired COM port as shown in Figure 8.

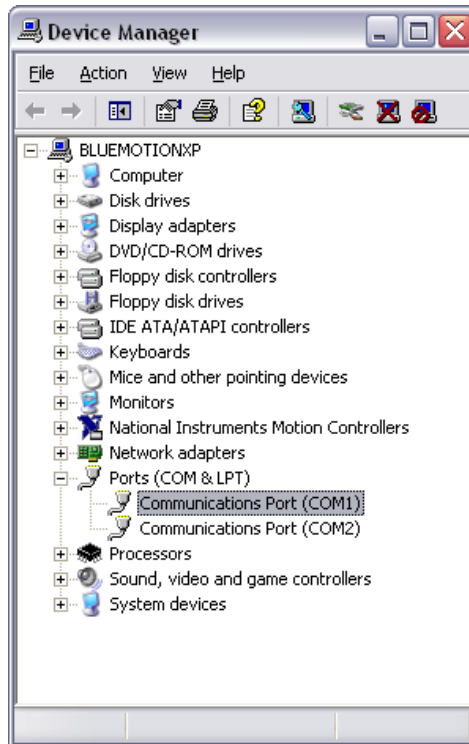

Figure 8. Selecting the COM1 Port in the Device Manager

3. Select the **Port Settings** tab and change the settings as shown in Figure 9. Click **OK** to apply the new settings. Close the Device Manager after this step.

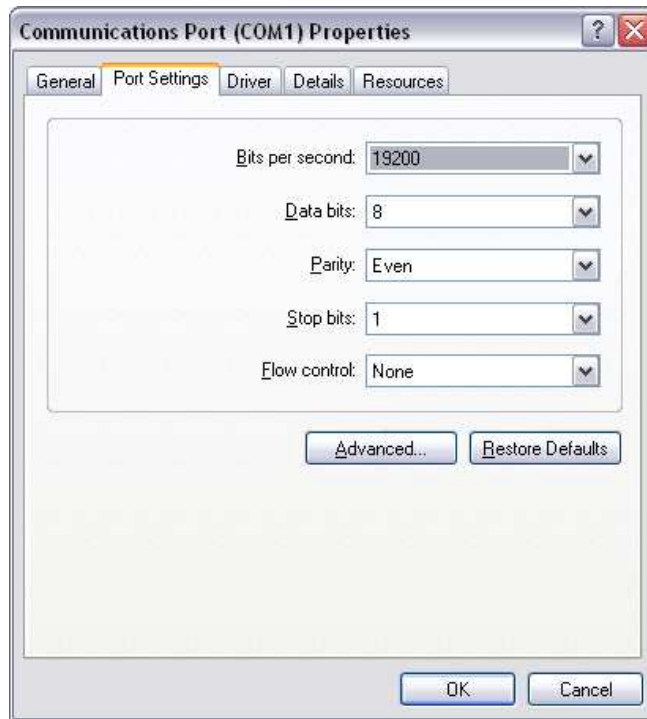

Figure 9. COM Port Settings

Step 5: Installing the P7000 Tools (Optional)

1. Install the P7000 Tools configuration software. You can find the software at ni.com/motion/stepper.



Note If you have a previous version of P7000 Tools on your system, the installation wizard automatically uninstalls it. After the previous version is uninstalled, you must run the installer again to install the new version.

2. Launch the P7000 Tools configuration software. The setup wizard appears as shown in Figure 10.



Figure 10. P7000 Setup Wizard

3. Click **Next**, and the P7000 software searches for connected drives on the COM1 port. Once detected, the product selection dialog appears as shown in Figure 11. You may enter a new name for the drive or leave the default.

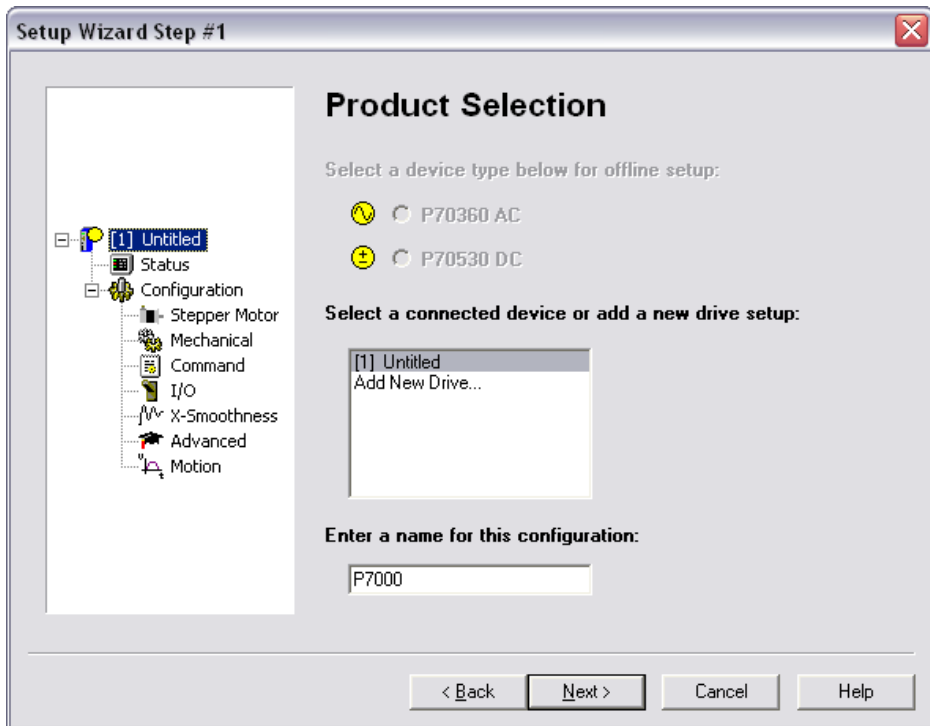

Figure 11. Product Selection

4. Click **Next**.

- In the motor selection dialog, shown in Figure 12, select the NI stepper motor you have connected to the drive. If you are using a third-party motor, select **None** from the list, click the **Motor File Editor** button, and enter the motor information. The T23NRLC motor is selected in this example.

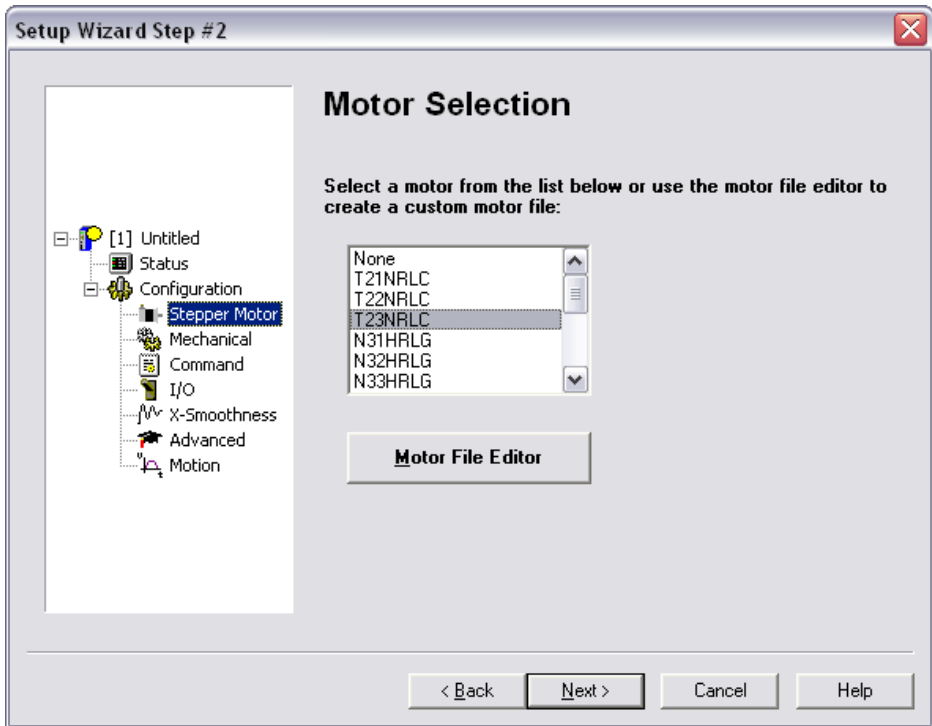

Figure 12. Motor Selection

- Click **Next**.
- Click **Next** in the mechanical information, command values, and I/O functions dialog boxes. No changes are required for these settings.
- Click **Finish**. Your drive setup is complete.

The P7000 Tools configuration software downloads the new configuration data to your drive and performs an initialization process with the motor. You may see a dialog box such as the one in shown Figure 13 when the configuration data is about to download. Click **Yes** to continue the download process.

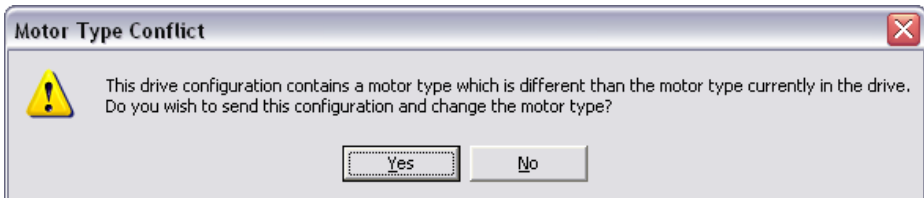

Figure 13. Motor Type Conflict

- When the configuration data is downloaded, the drive performs the initialization process with the motor as shown in Figure 14. Click **OK**.

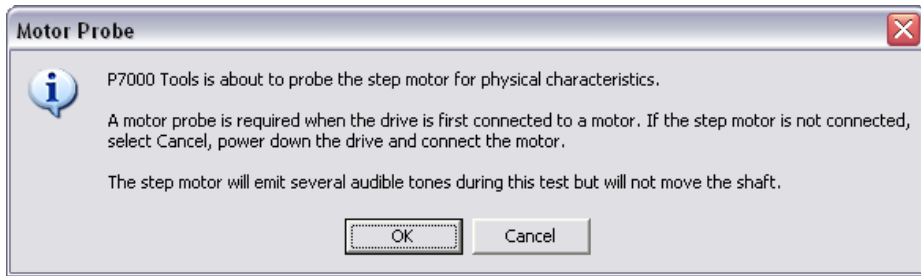

Figure 14. Drive and Motor Initialization



Caution The motor shaft rotates when performing the following test.

Step 6: Testing the Motor With the P7000 Tools (Optional)

Test the motor and P7000 series stepper drive configuration by jogging the motor in the negative and positive directions using the following arrows on the Motion Toolbar.

Icon	Behavior	Description
	Jog motor negative	Jogs the motor in the negative direction at the selected velocity.
	Jog velocity toggle	Selects the active jog velocity for the jog arrow buttons. (L designates low speed; H designates high speed.)
	Jog motor positive	Jogs the motor in the positive direction at the selected velocity.
	Stop motion	Stops all motion.



Note The RS-232 serial communication cable between the computer and P7000 series stepper drive is no longer needed, but you can leave it connected.

Step 7: Configuring the NI UMI

Follow these steps to connect and configure your NI UMI. (Refer to Figure 1 for more information about connecting the NI UMI to your stepper drive.)

- Connect your 68-pin shielded cable between the Motion I/O connector on your NI motion controller and the Motion I/O connector on your NI UMI.
- Connect the P7000 direct connect cable between the NI UMI and the P7000 series stepper drive.
If you are using the NI UMI-7774/7772, connect the cable between the Control connector on the NI UMI and the Command I/O connector on the drive. If you are using the NI UMI-7764, connect the leads from the cable to the correct screw terminal. The leads are labeled with the same signal

names as the NI UMI-7764 and can be connected to any axis terminal block. You can connect the ground lead to any ground pin on the NI UMI-7764. Refer to Table 14 for the wire colors.

Table 14. Wire Color Code for NI UMI-7764 to P7000 Direct Connect Cable

Wire Color	Signal Name
Blue	STEP (CW)
Red	DIR (CCW)
Purple	INHIN
Orange	<u>INHOUT</u>
Black	GND

Note: Overlined text indicates that a signal is active-low.

- Configure the NI UMI slide switches. You must set the NI UMI switches to match the polarity configuration for the P7000 series stepper drive, as shown in Tables 15 and 16.
- Connect power to the NI UMI:
 - If you are using the NI UMI-7764, connect a +5 V external power supply to the two-position terminal block labeled *required inputs*. Connect the positive lead of the +5 V power supply to the +5 V terminal, and the negative lead to the digital ground (GND) terminal.
 - If you are using the NI UMI-7774/7772, connect the positive lead of the +24 V external power supply to the V terminal and the negative lead to the C terminal, then connect the V terminal to the V_{iso} terminal and the C terminal to the C_{iso} terminal. Figure shows the power terminal block.

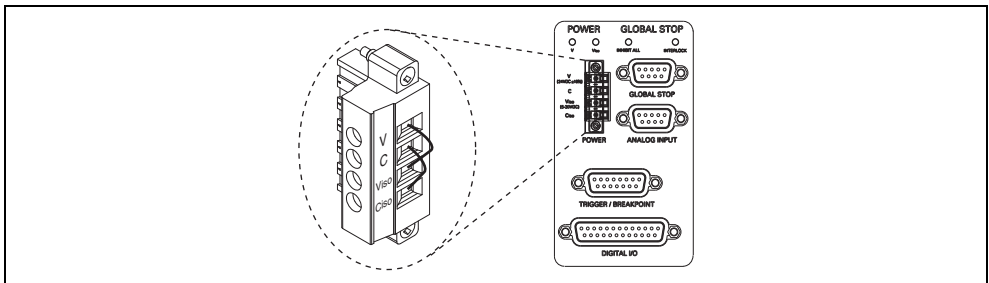

Figure 15. UMI-7772/7774 Power Connection



Note For more information about connecting external power, encoders, and other motion I/O signals, refer to the *Universal Motion Interface (UMI) Accessory User Guide and Specifications* or *National Instruments Universal Motion Interface (UMI)-7774/7772 User Manual and Specifications*.

Table 15. NI UMI-7774/7772 Switch Settings

Fault	Enable
Active low	Active high

Table 16. NI UMI-7764 Switch Settings

Inhibit Input	Inhibit Output
Active high	Active low

Step 8: Configuring Your NI Motion Controller Using Measurement & Automation Explorer (MAX)

To assist with configuring your NI motion controller, NI provides ready-made configuration files to configure your motion controller with the P7000 series stepper drives. To import these files, launch MAX and select **File»Import**. The Configuration Import Wizard appears as shown in Figure 16.

The MAX configuration files are installed at <NI-Motion>\Configuration, where <NI-Motion> is the location where you installed NI-Motion. In the **Import from file** dialog box, browse to this directory and select the appropriate file for your motion controller. Table 17 lists the MAX filename to import for each NI motion controller. After selecting the file, click **Next**.

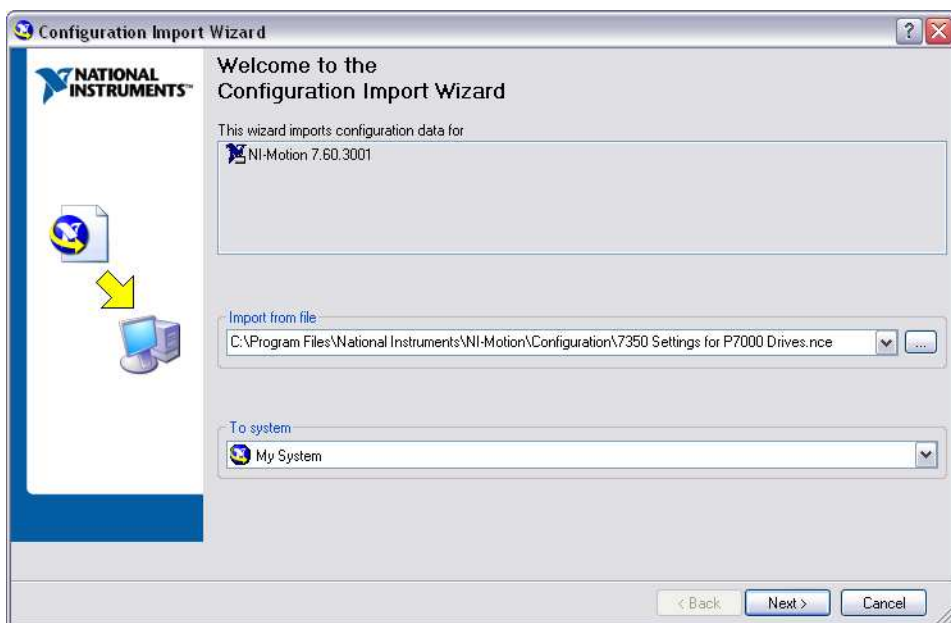

Figure 16. Configuration Import Wizard

Table 17. MAX Configuration Filenames for NI Motion Controllers

NI Motion Controller	Configuration File
NI PCI/PXI-7330	<NI-Motion>\Configuration\ 7330 Settings for P7000 Drives.nce
NI PCI/PXI-7340	<NI-Motion>\Configuration\ 7340 Settings for P7000 Drives.nce
NI PCI/PXI-7350	<NI-Motion>\Configuration\ 7350 Settings for P7000 Drives.nce

Verify that the settings being imported are checked. You also can select the device that uses the imported settings by clicking the **Import Only** link, as shown in Figure 17. After selecting the motion controller for the settings, click **Import**.

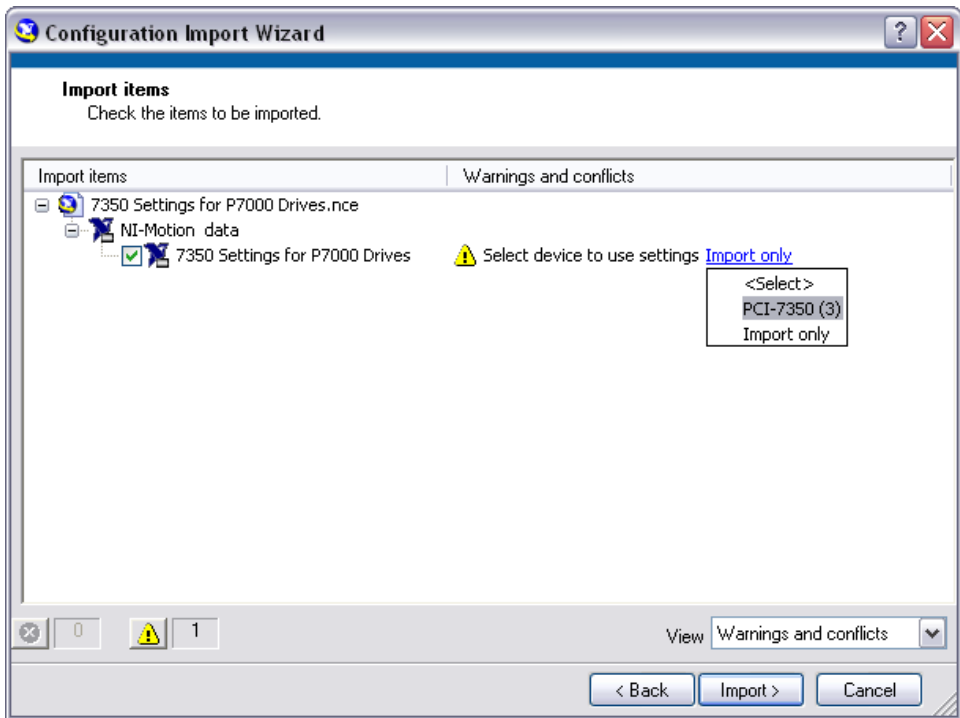

Figure 17. Importing MAX Settings

You also can change the settings a device is using by clicking **Change Settings** and selecting the desired settings, as shown in Figure 18.



Note The P7000 MAX configuration files are the same as the default settings, with the following changes:

- **Type** is changed to **Stepper** in the **Axis Configuration** tab under **Axis Configuration** in the MAX Configuration tree.
- **Stepper Loop Mode** is changed to **Open-Loop** and **Stepper Steps per Revolution** is changed to **5000** in the **Stepper Settings** tab under **Axis Configuration** in the MAX Configuration tree.
- The **Forward**, **Reverse**, and **Home Limit** switches are changed to **Disabled** in the **Motion I/O** tab under **Motion I/O Settings** in the MAX Configuration tree.

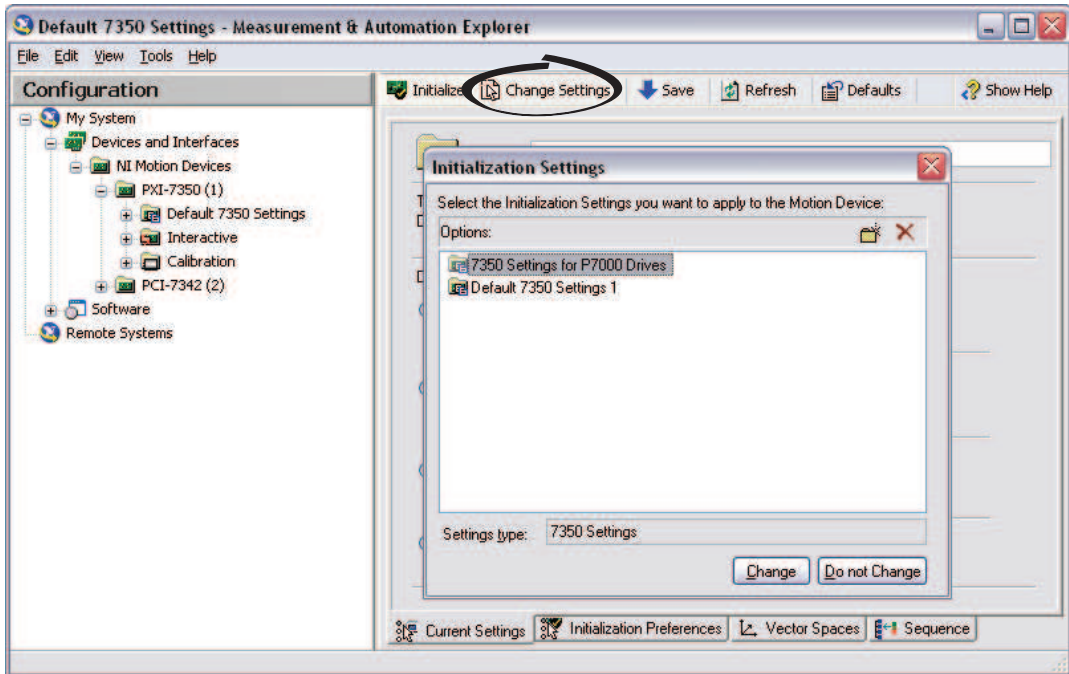

Figure 18. Choosing MAX Settings File

Click **Initialize** in MAX to send the settings to the NI motion controller, as shown in Figure 19.

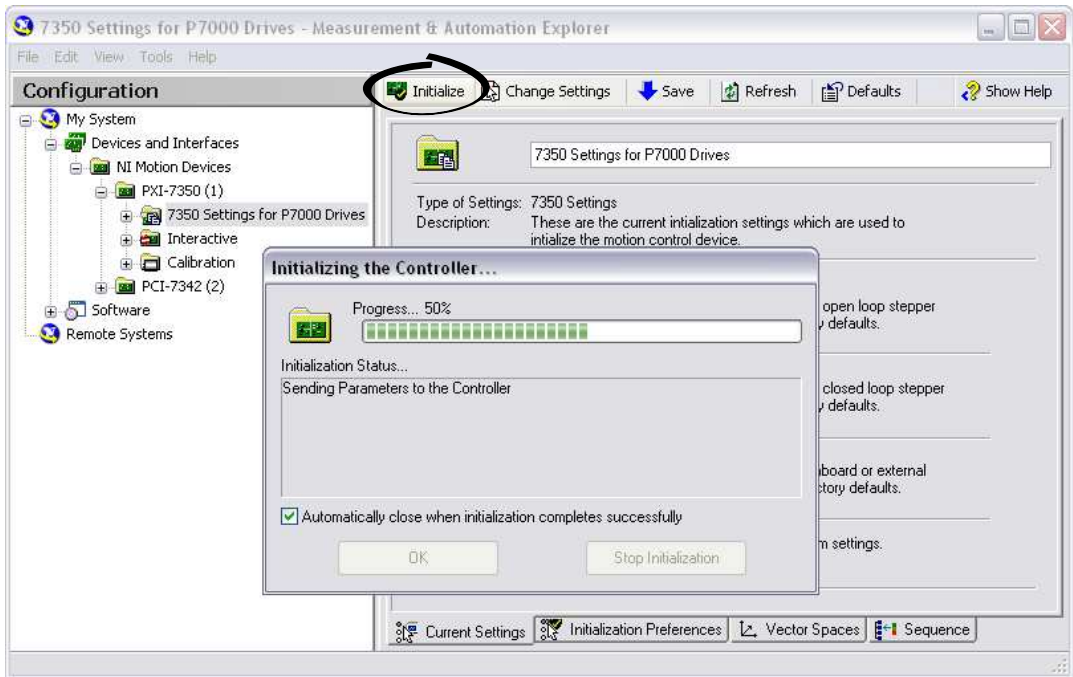

Figure 19. MAX Initialize Button

Step 9: Testing the Motor Using MAX

You will now move the motor using the NI motion controller and MAX. Select the **1-D Interactive** panel in the Configuration tree and change the settings to match those shown in Figure 20. Change the axis if you are not using Axis 1.

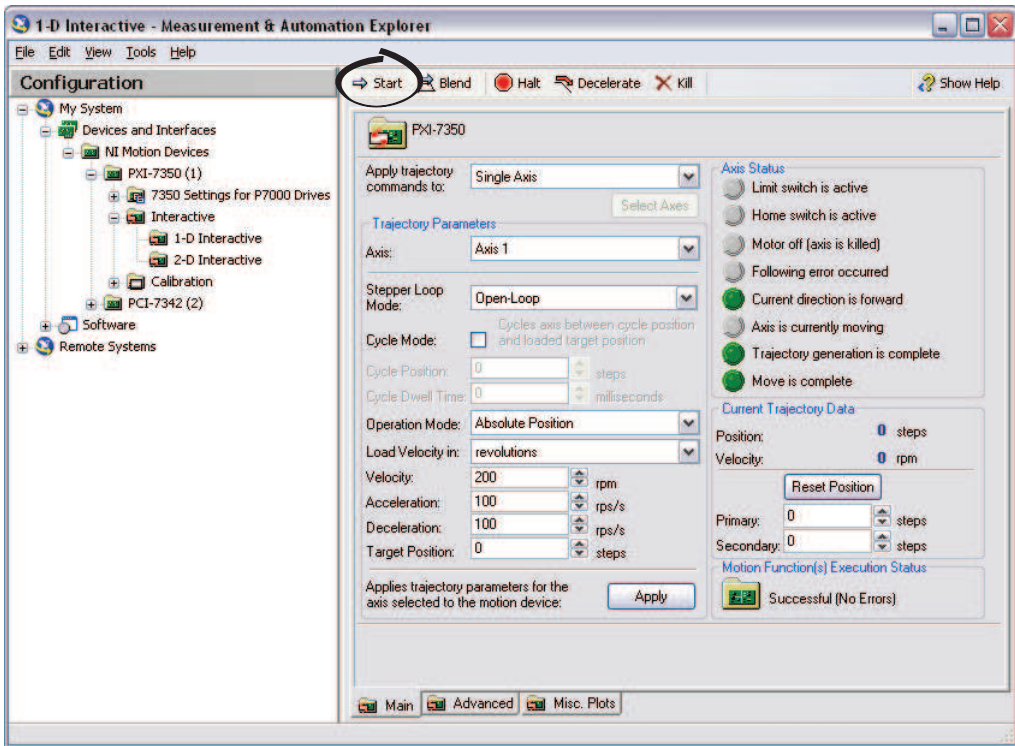

Figure 20. 1-D Interactive Panel Settings



Note Limits are disabled with these configuration files. National Instruments recommends enabling limits in your final application.

Click **Start**. Your stepper motor should move at the desired velocity.

Configuring Moves with NI Motion Assistant (Optional)

NI Motion Assistant is a motion control prototyping utility for quickly developing your motion control application. You can use interactive menus to set up and configure move profiles.

Complete the following steps to configure a simple one-axis straight line move using NI Motion Assistant.

1. Launch NI Motion Assistant by selecting **Start»All Programs»National Instruments»NI Motion Assistant**.
2. Click **Add Step**. Select **Straight Line Move** from the **Add Step** dialog box.
3. Click the **1D** button to set up a single axis move. Choose the axis you want to control.
4. Click the **Position** tab. Enter the number of steps or revolutions you want the motor to move.
5. Click **Run** on the toolbar to execute the move.

Exporting to LabVIEW

After prototyping your moves using NI Motion Assistant, you can export the move profile to LabVIEW for further motion control system development.

To export to LabVIEW, select **Tools»Generate Code»LabVIEW Diagram**.

Figure 21 shows an example block diagram generated from NI Motion Assistant. To execute the code, click the **Run** arrow in the LabVIEW toolbar.

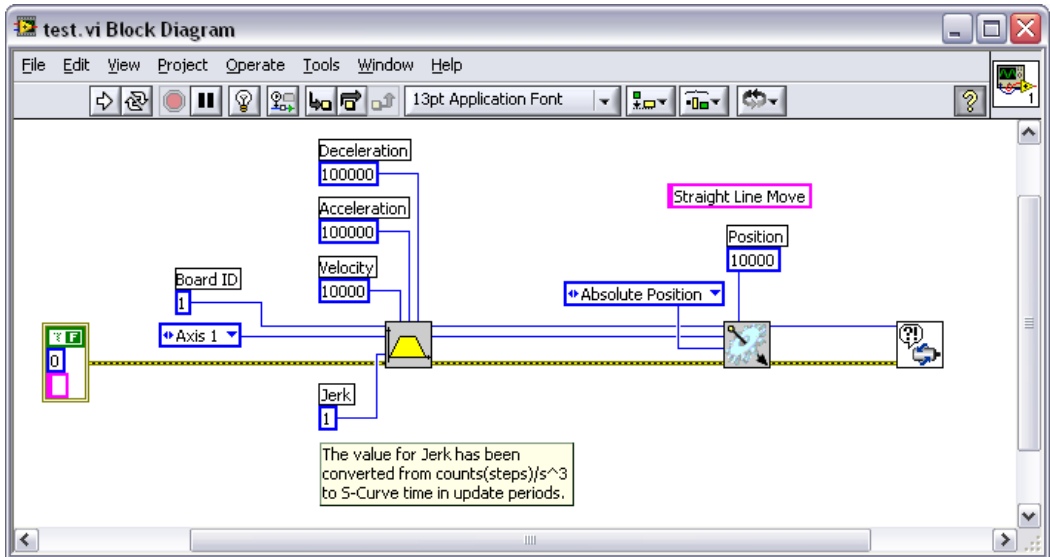

Figure 21. LabVIEW Block Diagram of Motion Assistant Code

You have now successfully built a LabVIEW application to move a stepper motor using a P7000 series stepper drive. You are now ready to develop advanced applications. For additional information, refer to ni.com/motion/stepper.

Troubleshooting the P7000 Series Stepper Drive

Table 18 lists problems you may encounter with the P7000 series stepper drive and their possible causes.

Table 18. P7000 Series Stepper Drive Troubleshooting

Problem	Possible Causes
The status LED on the drive is off, blinks, or is red.	The power source is not properly connected. Refer to the P70360 or P70530 Reference Guide for detailed LED troubleshooting.
The motor does not move using the jog toolbar in the P7000 Tools configuration software.	The DIP switches are not properly configured.
	The DIP switches were changed but the drive was not power cycled.
Motor gets hot when idle.	Current reduction is disabled.
Motor moves backwards.	Refer to <i>Step 1: Connecting the Stepper Motor to the Drive</i> .
The P7000 Tools configuration software does not detect the drive.	Verify that the drive is connected to the COM1 port on the computer.
	Verify that the COM1 port settings are correct as described in <i>Step 4: Configuring the P7000 Drive with the Serial Port (Optional)</i> .
	Power is not properly connected. Verify that the green LED is on.

Where to Go for Support

The National Instruments Web site is your complete resource for technical support. At ni.com/support you have access to everything from troubleshooting and application development self-help resources to email and phone assistance from NI Application Engineers.

National Instruments corporate headquarters is located at 11500 North Mopac Expressway, Austin, Texas, 78759-3504. National Instruments also has offices located around the world to help address your support needs. For telephone support in the United States, create your service request at ni.com/support and follow the calling instructions or dial 512 795 8248. For telephone support outside the United States, contact your local branch office. Visit the *Worldwide Offices* section of ni.com/niglobal to access the branch office Web sites, which provide up-to-date contact information, support phone numbers, email addresses, and current events.

CVI, LabVIEW, National Instruments, NI, ni.com, the National Instruments corporate logo, and the Eagle logo are trademarks of National Instruments Corporation. Refer to the *Trademark Information* at ni.com/trademarks for other National Instruments trademarks. The mark LabWindows is used under a license from Microsoft Corporation. Windows is a registered trademark of Microsoft Corporation in the United States and other countries. Other product and company names mentioned herein are trademarks or trade names of their respective companies. For patents covering National Instruments products/technology, refer to the appropriate location: **Help»Patents** in your software, the `patents.txt` file on your media, or the *National Instruments Patent Notice* at ni.com/patents.