

COMPREHENSIVE SERVICES

We offer competitive repair and calibration services, as well as easily accessible documentation and free downloadable resources.

SELL YOUR SURPLUS

We buy new, used, decommissioned, and surplus parts from every NI series. We work out the best solution to suit your individual needs.

 Sell For Cash  Get Credit  Receive a Trade-In Deal

OBSOLETE NI HARDWARE IN STOCK & READY TO SHIP

We stock **New**, **New Surplus**, **Refurbished**, and **Reconditioned** NI Hardware.



Bridging the gap between the manufacturer and your legacy test system.

 1-800-915-6216

 www.apexwaves.com

 sales@apexwaves.com

All trademarks, brands, and brand names are the property of their respective owners.

Request a Quote

 **CLICK HERE**

UMI-7774

GETTING STARTED

NI ISM-7400/7401/7402

Integrated Steppers and NI 73xx Motion Controllers

This document explains how to install and configure the NI ISM-7400/7401/7402 integrated steppers for use with the NI 7330/7340/7350 motion controllers.



Tip If you encounter any problems during setup, refer to the [Worldwide Support and Services](#) section for assistance.

Contents

Connecting and Using the NI ISM-7400/7401/7402 with the NI UMI-7772/7774	2
What You Need to Get Started	2
Hardware	2
Software	3
NI Motion Controller Configuration and Installation	3
Step 1: Install NI-Motion	4
Step 2: Install the NI 73xx Motion Controller	4
Step 3: Install Software on and Configure the RT PXI Controller (PXI Motion Controllers Only)	5
NI UMI-7772/7774 and NI ISM-74xx Configuration and Installation	7
Step 1: Connect and Configure the UMI-7772/7774	7
Step 2: Connect the Drive Command Signals to the UMI-7772/7774	9
Step 3: Connect the Drive Enable Signal to the UMI-7772/7774	10
Step 4: (Optional) Connect the Drive Fault Signal to the UMI-7772/7774	10
Step 5: (Optional) Connect the Encoder Signals to the UMI-7772/7774	11
Step 6: Connect the NI PS-12/13 Power Supply to the NI ISM-74xx	12
Step 7: Configure the NI ISM-7400/7401/7402 DIP Switches	12
Step 8: Cut Off and Insulate the NC Wire	14
Step 9: Power on the Drive and Verify Connections	15
Connecting and Using the NI ISM-7400/7401/7402 with the NI UMI-7764	16
What You Need to Get Started	16
Hardware	16
Software	16
NI Motion Controller Configuration and Installation	17
Step 1: Install NI-Motion	17
Step 2: Install the NI 7330/7340/7350 Motion Controller	18

Step 3: Install Software on and Configure the RT PXI Controller (PXI Motion Controllers Only)	19
UMI-7764 and NI ISM-74xx Configuration and Installation.....	21
Step 1: Connect and Configure the NI UMI-7764.....	21
Step 2: Connect the Drive Command Signals to the UMI-7764	22
Step 3: Connect the Drive Enable Signal to the UMI-7764	25
Step 4: (Optional) Connect the Drive Fault Signal to the UMI-7764.....	25
Step 5: (Optional) Connect the Encoder Signals to the UMI-7764	26
Step 6: Connect the NI PS-12/13 Power Supply	27
Step 7: Configure the NI ISM-7400/7401/7402 DIP Switches	28
Step 8: Cut Off and Insulate the NC Wire	29
Step 9: Power on the Drive and Verify Connections.....	30
Software Installation and Configuration	30
Step 1: Update Firmware on the Motion Controller.....	30
Step 2: Configure the NI Motion Controller.....	31
Step 3: Test the Motor In MAX.....	32
Where to Go Next	33
Worldwide Support and Services	34

Connecting and Using the NI ISM-7400/7401/ 7402 with the NI UMI-7772/7774

What You Need to Get Started

You need the following items to get started.

Hardware

- A computer with an available PXI or PCI slot
- NI 7330, NI 7340, or NI 7350 motion controller
- UMI-7772/7774
- SHC68-C68-S cable to connect your NI UMI and motion controller
- (Optional) DB9M/DB15M/DB25M cables for UMI-7772/7774 connectivity
- +24 ±10% VDC power supply (10 W minimum) for the NI UMI-7772/7774
- (Optional) +5 to +30 V isolated power supply (10 to 60 W minimum, depending on I/O requirements)



Note The same power supply may be used for both the main +24 V power supply and I/O. However, if you use the same power supply for both connections, there will be no isolation between the I/O and the main power.

- Snap-on ferrite beads for the power supply cable(s) (included with your NI UMI-7772 or NI UMI-7774). You must use a separate ferrite bead for each power supply cable. Refer to the *NI UMI-7772/7774 User Guide and Specifications* for installation information.
- NI PS-12 or NI PS-13 power supply for the NI integrated stepper
- NI ISM-7400/7401/7402 integrated stepper

Software

- NI-Motion 7.6 or later driver software



Tip Refer to KB 4WRDJ3WA, *Which LabVIEW Version Supports NI-Motion?*, at ni.com/KB, for NI-Motion/LabVIEW version compatibility information.

- One of the following software packages and documentation:
 - LabVIEW 8.5 or later
 - LabWindows™/CVI™ 8.5 or later
 - Microsoft Visual C++ 6.0
 - Microsoft Visual Basic 6.0

Figure 1 shows the hardware connections using a UMI-7772/7774.

Figure 1. UMI-7772/7774 to ISM Drive Connections

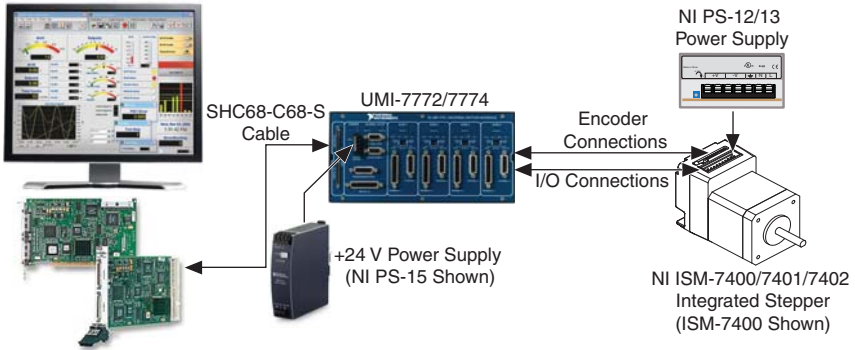

NI Motion Controller Configuration and Installation



Caution Before installing the NI 7330/7340/7350 motion controller refer to the user manual appropriate to your controller for safety and specification information. Failure to follow safety instructions may result in damage to equipment.

Step 1: Install NI-Motion

You must install the NI-Motion driver software *before* installing an NI motion controller for the first time. If you are upgrading from a previous version of NI-Motion, it is not necessary to remove the NI motion controller before installing the upgrade. The upgrade does not affect the existing Microsoft Windows configuration.



Note If you are using a Real-Time OS, install LabVIEW Real-Time on the development computer before installing NI-Motion so that the RT support files install.

Complete the following steps to install the NI-Motion driver software:

1. Insert the NI-Motion CD into the CD-ROM drive to display the NI-Motion installation screen, or download the latest version from ni.com/downloads.
2. If you have autorun enabled, `autorun.exe` runs automatically. Otherwise, double-click `autorun.exe`.
3. Follow the onscreen instructions.



Note You must update the firmware on your NI motion controller(s) before you can use them with the corresponding version of NI-Motion. Refer to [Step 1: Update Firmware on the Motion Controller](#) in the [Software Installation and Configuration](#) section for detailed instructions.

Step 2: Install the NI 73xx Motion Controller

The following sections explain how to install PXI and PCI motion controllers.



Note When adding or removing the motion controller, you must be logged on with administrator-level access. After you have restarted the system, you may need to refresh Measurement & Automation Explorer (MAX) to view the new controller.

PXI Controllers

1. Power off and unplug the chassis.



Caution To protect yourself and the computer from electrical hazards, the computer *must* remain unplugged until the installation is complete.

2. Choose an unused peripheral slot and remove the filler panel.
3. Touch a metal part on the chassis to discharge any static electricity that might be on your clothes or body. Static electricity can damage the controller.
4. Insert the PXI controller into the chosen slot. Use the injector/ejector handle to fully secure the device into place.
5. Attach the front panel of the PXI controller to the front panel mounting rails of the chassis with the slot screws on the chassis.



Caution Always power on the computer containing the motion controller and initialize the controller before you power on the rest of the motion system. Power off the motion system in the reverse order.

6. Plug in and power on the chassis.

PCI Controllers

1. Power off and unplug the computer.



Caution To protect yourself and the computer from electrical hazards, the computer *must* remain unplugged until the installation is complete.

2. Open the computer case to expose access to the PCI expansion slots.
3. Touch a metal part on the chassis to discharge any static electricity that might be on your clothes or body. Static electricity can damage the controller.
4. Choose an unused +3.3 V or +5 V PCI slot, and remove the corresponding expansion slot cover on the back panel of the computer.
5. Gently rock the controller into the slot. The connection may be tight, but do *not* force the controller into place.



Note Check that the bracket of the device aligns with the hole in the back panel rail of the computer chassis.

6. Secure the mounting bracket of the controller to the back panel rail of the computer.
7. Replace the cover.



Caution Always power on the computer containing the motion controller, and then initialize the controller before you power on the rest of the motion system. Power off the motion system in the reverse order.

8. Plug in and power on the computer.

Step 3: Install Software on and Configure the RT PXI Controller (PXI Motion Controllers Only)



Note This step is only required if you are using a PXI-7330/7340/7350 motion controller and an RT PXI controller. If you are not using an RT PXI controller, skip to the [NI UMI-7772/7774](#) and [NI ISM-74xx Configuration and Installation](#) section.

Complete the following steps to configure the controller and install software on it.



Note The Measurement & Automation Explorer (MAX) user interface may not match these steps exactly depending on which version of MAX you are using.

1. Boot the NI PXI embedded controller into the real-time operating system. The PXI controller automatically boots into LabVIEW RT Safe Mode when no software is installed. LabVIEW RT Safe Mode loads with the basic real-time operating system and automatically attempts to connect to the network using DHCP. If DHCP is not available, the controller connects to the network with a link-local IP address.



Tip You can connect a monitor to the PXI to display startup messages such as the IP address and MAC address.

2. Launch Measurement & Automation Explorer (MAX) on the development computer by clicking the MAX icon on the desktop (), or by selecting **Start»All Programs»National Instruments»Measurement & Automation**.
3. Expand the **Remote Systems** branch. MAX lists the PXI controller as the model name of the controller followed by the MAC address (for example, **NI-PXI-8104 00802f108562**).



Tip Record the PXI controller MAC address, located on the side of the controller, for use in identifying the controller. The label also can be removed and placed on the front of the controller for easier access. If you have connected the PXI controller to a monitor, the MAC address also appears when the PXI system boots up.

4. Select the **System Settings** tab and type a descriptive name for the system in the **Name** field.
5. (Optional) Complete this step only if the target has an empty IP address (0.0.0.0). Select the **Network Settings** tab and select **DHCP or Link Local** from the **Configure IPv4 Address** list to assign an IP address or select **Static** to specify a static IP address in the **IPv4 Address** section.
6. Click **Save** on the toolbar and let MAX reboot the system.
7. When the new system name appears under **Remote Systems**, expand the controller item in the tree, right-click **Software**, and select **Add/Remove Software**.
8. Install the LabVIEW Real-Time software and NI-Motion on the RT target. Go to ni.com/info and enter `etspc` for the latest information about supported software.
9. Click **Next** to install the selected software on the controller. Click **Help** if you need information about installing recommended software sets.
10. Wait for installation to complete, then click **Finish**.
11. Expand the **Devices and Interfaces** item under the PXI system.
12. Right-click the remote motion controller icon and select **Map to Local Machine**. This assigns a local board ID to the remote motion controller in the host system.
13. Mapping the remote controller into the local system allows you to configure the controller through MAX exactly as you would a controller that is in the host system. You can initialize the controller, download firmware, and use the interactive and configuration panels exactly as you would on a controller installed in the host machine. You also can write VIs using the remote motion controller through the local board ID assigned to it.

This allows you to write and debug your VIs on the host, and then download them to the remote system when you are ready. All you need to change is the board ID in your VI from the locally assigned Board ID to the ID assigned by the remote system.

14. Browse to **Devices and Interfaces** under **My System**, where there is a shortcut icon next to a new controller name.

For example, if the motion controller on the remote system is a PXI-7354, and the remote system has an IP address of 123.45.678.9, then the shortcut device would show a name like **PXI-7354 (X) on 123.45.678.9 (Y)**.

X is the board ID assigned to the board by the remote system. Use this board ID for VIs that are downloaded to the remote system through LabVIEW RT.

Y is the board ID assigned to the remote motion controller by the local system. Use this board ID for any VIs that run on the host and use the remote motion controller.

15. Close MAX.

NI UMI-7772/7774 and NI ISM-74xx Configuration and Installation

This section covers the hardware setup for the NI UMI-7772/7774 and NI ISM-74xx integrated steppers. If you are using a UMI-7764 refer to the [Connecting and Using the NI ISM-7400/7401/7402 with the NI UMI-7764](#) section.

Step 1: Connect and Configure the UMI-7772/7774

Complete the following steps to connect and configure the UMI-7772/7774.



Tip For more information about connecting external power, encoders, and other motion I/O signals to the UMI-7772/7774, refer to the *National Instruments Universal Motion Interface (UMI)-7772/7774 User Manual and Specifications*.

1. Connect the SHC68-C68-S 68-pin shielded cable between the Motion I/O connector on the NI 73xx motion controller and the Motion I/O connector on the UMI-7772/7774.
2. Configure the UMI-7772/7774 DIP switches. You must set the UMI-7772/7774 switches to the following settings to match the polarity configuration for the NI ISM-74xx:
 - Fault—Active High
 - Enable—Active High

The UMI-7772/7774 DIP switch configuration is shown in Figure 2.

Figure 2. UMI-7772/7774 Fault and Enable DIP Switch Settings

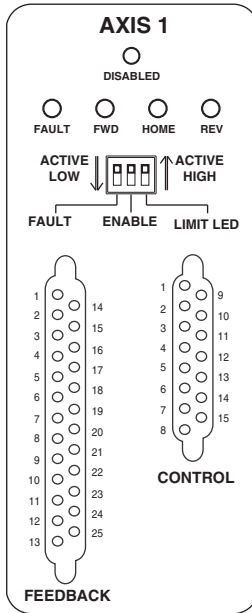

Note Configuring the limit and home status LEDs on the UMI-7772/7774 does not configure the limit and home inputs themselves as active-high or active-low. You must configure the limit and home inputs separately on the National Instruments motion controller using MAX or the NI-Motion driver software. This DIP switch does not need to be configured when the UMI-7772/7774 is used with integrated steppers.

3. Connect the positive lead of the +24 V external power supply to the V terminal and the negative lead to the C terminal, then connect the V terminal to the V_{iso} terminal and the C terminal to the C_{iso} terminal. If you require isolation, you can connect a separate 5 to 30 VDC power supply to the V_{iso} and C_{iso} terminals to use the isolation feature of the UMI-7772/7774. Refer to the *NI UMI-7772/7774 User Guide and Specifications* for more information.



Caution Do not plug in or turn on any power to the system until after all hardware connections are complete.

Figure 3 shows the power terminal block.

Figure 3. UMI-7772/7774 Power Connection

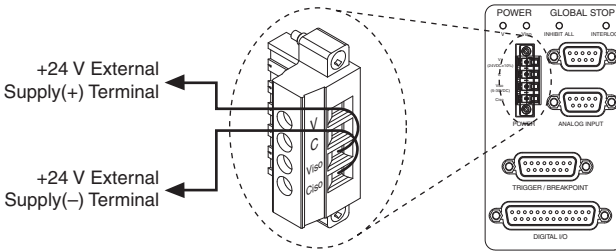

Step 2: Connect the Drive Command Signals to the UMI-7772/7774

Complete the following steps to connect the Drive Command signals to the UMI-7772/7774.

1. Connect the DB15M pigtail cable to the UMI-7772/7774 Axis 1 Control connector.
2. Connect the integrated stepper Step- wire (brown) to the DB15M cable pin 4 wire (orange) which corresponds to the UMI-7772/7774 Step (CW) terminal.
3. Connect the integrated stepper Dir- wire (green) to the DB15M cable pin 12 wire (light green) which corresponds to the UMI-7772/7774 Dir (CCW) terminal.
4. Connect the integrated stepper Step+ wire (orange) and Dir+ wire (yellow) to the DB15M cable pin 3 wire (red) which corresponds to the UMI-7772/7774 +5V OUT terminal.

Figure 4 shows the connections.

Figure 4. NI ISM-7400/7401/7402 to DB15M Cable Drive Command Connections

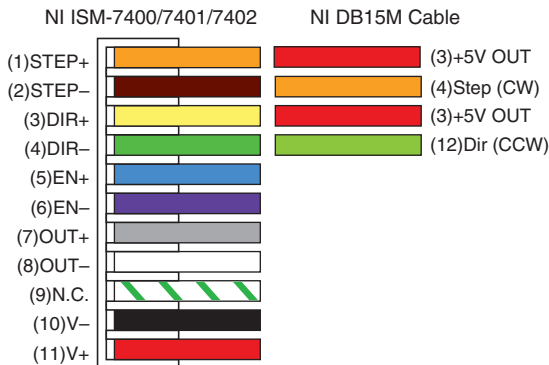

Step 3: Connect the Drive Enable Signal to the UMI-7772/7774

Complete the following steps to connect the Drive Enable signal, which controls the enable function of the drive.

1. Connect the En- wire (purple) to the DB15M cable pin 15 wire (red/white) which corresponds to the UMI-7772/7774 C_{iso} terminal.
2. Connect the En+ wire (blue) to the DB15M cable pin 6 wire (green) which corresponds to the UMI-7772/7774 Enable terminal.

Figure 5 shows the connections.

Figure 5. NI ISM-7400/7401/7402 to DB15M Cable Enable Connections

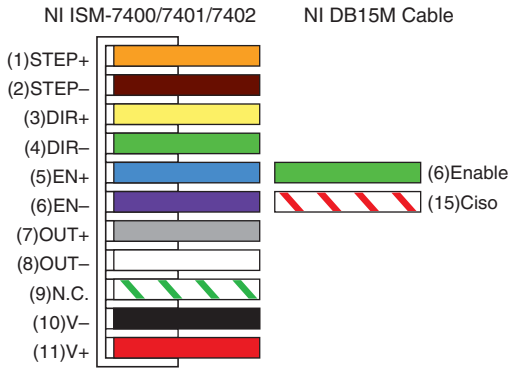

Step 4: (Optional) Connect the Drive Fault Signal to the UMI-7772/7774

Complete the following optional steps to connect the drive fault signal to monitor the NI integrated stepper for faults.



Note If you do not connect the Out+ and Out- signals to the UMI-7772/7774, insulate the wires.

1. Connect the Out+ wire (grey) to the DB15M cable pin 8 wire (purple) which corresponds to the UMI-7772/7774 V_{iso} terminal.
2. Connect the Out- wire (white) to the DB15M cable pin 7 wire (blue) which corresponds to the UMI-7772/7774 Fault+ terminal.
3. Connect the DB15M cable pin 14 wire (brown/white) which corresponds to the UMI-7772/7774 Fault- terminal to the DB15M cable pin 15 wire (red/white) which corresponds to the UMI-7772/7774 C_{iso} terminal.

Figure 6 shows the connections.

Figure 6. NI ISM-7400/7401/7402 to DB15M Cable Drive Fault Connections

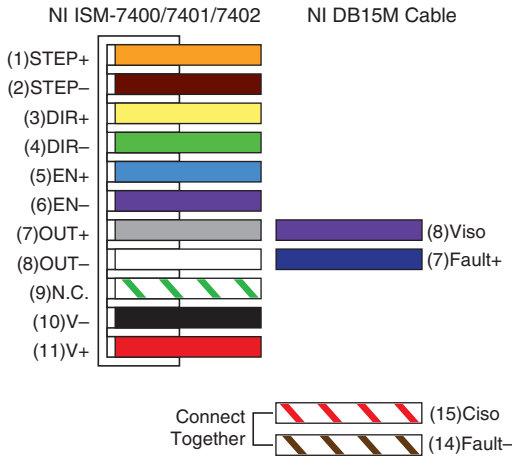

Step 5: (Optional) Connect the Encoder Signals to the UMI-7772/7774

If your NI ISM includes an encoder, connect the encoder signals to the UMI-7772/7774.

1. Connect the DB25M pigtail cable to the UMI-7772/7774 Axis 1 Feedback connector.
2. Connect the encoder wires to the DB25M cable as indicated in Table 1.

Table 1. NI ISM to UMI-7772/7774 Connections

NI ISM Signal Name	NI ISM Wire Color	DB25M Wire Number (Color)	UMI-7772/7774 Signal Name
A	blue	1 (black)	Encoder Phase A
\bar{A}	blue/white	14 (brown/white)	Encoder Phase A-
B	brown	2 (brown)	Encoder Phase B
\bar{B}	brown/white	15 (red/white)	Encoder Phase B-
I	orange	3 (red)	Encoder Index
\bar{I}	orange/white	16 (orange/white)	Encoder Index-
GND	green/white	17 (green/white)	Digital Ground
+5V	green	4 (orange)	+5V OUT

Step 6: Connect the NI PS-12/13 Power Supply to the NI ISM-74xx



Note Do not plug in or turn on the power supply until after you complete [Step 9: Power on the Drive and Verify Connections](#).

Complete the following steps to connect the power supply to AC input power and to the NI integrated stepper. Figure 7 shows the power supply terminals.

Figure 7. NI PS-12/13 Power Supply Terminals

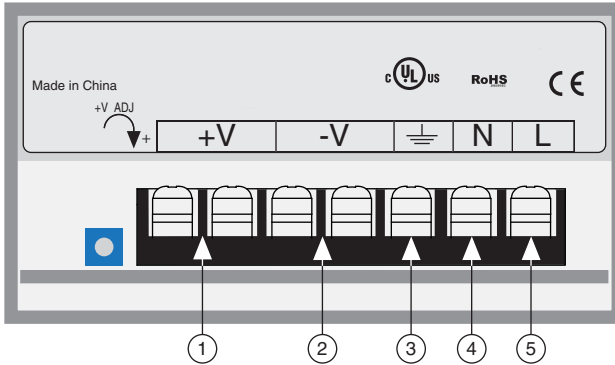

1	+24 V (NI PS-12) or +48 V (NI PS-13) Output	4	AC Input Neutral
2	+24 V (NI PS-12) or +48 V (NI PS-13) Ground	5	AC Input Line
3	AC Input Ground (Protective Earth)		

1. Connect the an AC input cable to the line, neutral, and ground connectors.
2. Connect the integrated stepper V+ (red) wire to the power supply +V connector.
3. Connect the integrated stepper V- (black) wire to the power supply -V connector.
4. Connect the NI UMI power supply ground/common terminal and NI PS-12/13 power supply ground connections to ensure a common reference.

Step 7: Configure the NI ISM-7400/7401/7402 DIP Switches

The NI ISM-7400/7401/7402 integrated steppers provide drive configuration DIP switches. Refer to the *NI ISM-7400/7401/7402 User Manual* for more information about the DIP switch options. The following figure shows the DIP switch location and functions.



Note If you change the DIP switch settings you must power cycle the NI ISM for the new settings to take effect.

Figure 8. NI ISM-7400/7401/7402 DIP Switches

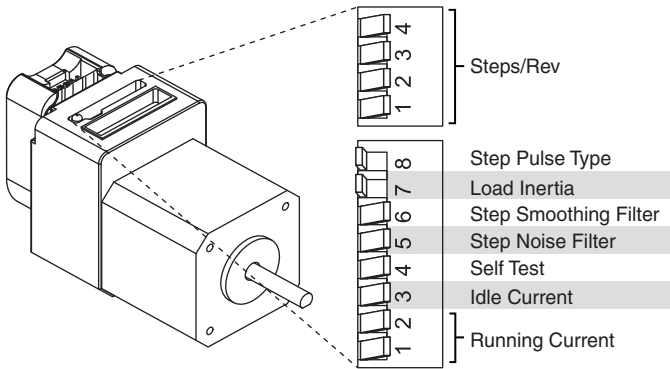

Refer to Table 2 for the DIP switch settings that this document uses.

Table 2. DIP Switch Settings







Setting Name	Switch Position	Corresponding Value
Running Current		100%
Idle Current		50%
Self Test		Off
Step Noise Filter		2 MHz
Step Smoothing Filter		Off

Table 2. DIP Switch Settings (Continued)

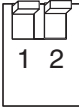
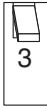
Setting Name	Switch Position	Corresponding Value
Load Inertia		0 - 4X
Step Pulse Type		Step/Dir
Step Size		25000

Step 8: Cut Off and Insulate the NC Wire

The NC wire on the NI ISM-7400/7401/7402 is unused. NI recommends removing and insulating this wire.

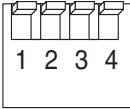
1. Cut off the NC wire.
2. Insulate the end of the wire if there is any exposed metal remaining.

Step 9: Power on the Drive and Verify Connections

After all hardware connections have been made complete the following steps to confirm the hardware setup.

1. Turn on all power supplies.
2. Verify that the Drive Status LED on the NI ISM flashes or is solid green. Figure 9 shows the location of the Drive Status LED.

Figure 9. NI ISM-7400/7401/7402 Drive Status LED Location

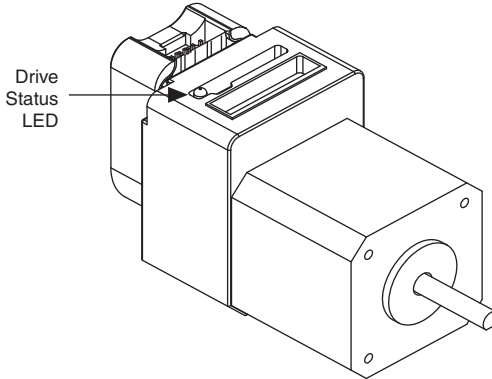

If the Drive Status LED does not flash or turn solid green, turn off all power, verify the connections, and try again.

3. Verify that the **V** LED on the UMI-7772/7774 illuminates. If the 24 VDC power supply has also been connected to the V_{iso} and C_{iso} terminals, the **Viso** LED illuminates. If you are using a separate power supply to provide isolation, power on the separate 5 to 30 V power supply and the **Viso** LED indicator illuminates. Figure 10 shows the location of the **V** and **Viso** LEDs.

Figure 10. UMI-7772/7774 **V** and V_{iso} LED Location

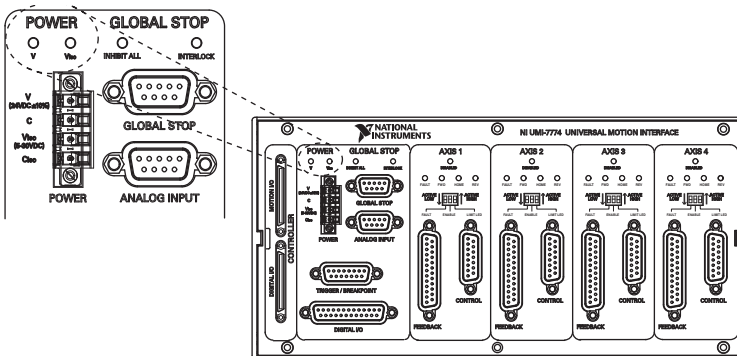

If the **V** and **Viso** LEDs do not illuminate, turn off all power, verify the connections, and try again.



Note Refer to the [Software Installation and Configuration](#) section after the [Connecting and Using the NI ISM-7400/7401/ 7402 with the NI UMI-7764](#) section to continue setting up your system.

Connecting and Using the NI ISM-7400/7401/ 7402 with the NI UMI-7764

What You Need to Get Started

You need the following items to get started.

Hardware

- A computer with an available PXI or PCI slot
- NI 7330, NI 7340, or NI 7350 motion controller
- UMI-7764
- SH68-C68-S cable to connect your NI UMI and motion controller
- +5 V power supply for the UMI-7764
- Snap-on ferrite bead for the power supply cable (included with your NI UMI-7764). Refer to the *UMI-7764 User Guide and Specifications* for installation information.
- NI PS-12 or NI PS-13 power supply for the NI integrated stepper
- NI ISM-7400/7401/7402 integrated stepper

Software

- NI-Motion 7.6 or later driver software



Tip Refer to KB 4WRDJ3WA, [Which LabVIEW Version Supports NI-Motion?](#), at ni.com/kb, for NI-Motion/LabVIEW version compatibility information.

- One of the following software packages and documentation:
 - LabVIEW 8.5 or later
 - LabWindows/CVI 8.5 or later
 - Microsoft Visual C++ 6.0
 - Microsoft Visual Basic 6.0

Figure 11 shows the hardware connections using a UMI-7764.

Figure 11. UMI-7764 to ISM Drive Connections

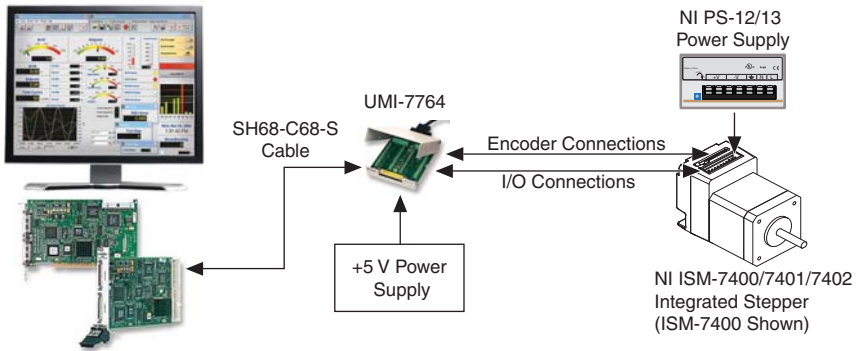

NI Motion Controller Configuration and Installation



Caution Before installing the NI 7330/7340/7350 motion controller refer to the user manual appropriate to your controller for safety and specification information. Failure to follow safety instructions may result in damage to equipment.

Step 1: Install NI-Motion

You must install the NI-Motion driver software *before* installing an NI motion controller for the first time. If you are upgrading from a previous version of NI-Motion, it is not necessary to remove the NI motion controller before installing the upgrade. The upgrade does not affect the existing Microsoft Windows configuration.



Note If you are using a Real-Time OS, install LabVIEW Real-Time on the development computer before installing NI-Motion so that the RT support files install.

Complete the following steps to install the NI-Motion driver software:

1. Insert the NI-Motion CD into the CD-ROM drive to display the NI-Motion installation screen, or download the latest version from ni.com/downloads.
2. If you have autorun enabled, `autorun.exe` runs automatically. Otherwise, double-click `autorun.exe`.
3. Follow the onscreen instructions.



Note You must update the firmware on your NI motion controller(s) before you can use them with the corresponding version of NI-Motion. Refer to [Step 1: Update Firmware on the Motion Controller](#) in the *Software Installation and Configuration* section for detailed instructions.

Step 2: Install the NI 7330/7340/7350 Motion Controller

The following sections explain how to install PXI and PCI motion controllers.



Note When adding or removing the motion controller, you must be logged on with administrator-level access. After you have restarted the system, you may need to refresh Measurement & Automation Explorer (MAX) to view the new controller.

PXI Controllers

1. Power off and unplug the chassis.



Caution To protect yourself and the computer from electrical hazards, the computer *must* remain unplugged until the installation is complete.

2. Choose an unused peripheral slot and remove the filler panel.
3. Touch a metal part on the chassis to discharge any static electricity that might be on your clothes or body. Static electricity can damage the controller.
4. Insert the PXI controller into the chosen slot. Use the injector/ejector handle to fully secure the device into place.
5. Attach the front panel of the PXI controller to the front panel mounting rails of the chassis with the slot screws on the chassis.



Caution Always power on the computer containing the motion controller and initialize the controller before you power on the rest of the motion system. Power off the motion system in the reverse order.

6. Plug in and power on the chassis.

PCI Controllers

1. Power off and unplug the computer.



Caution To protect yourself and the computer from electrical hazards, the computer *must* remain unplugged until the installation is complete.

2. Open the computer case to expose access to the PCI expansion slots.
3. Touch a metal part on the chassis to discharge any static electricity that might be on your clothes or body. Static electricity can damage the controller.
4. Choose an unused +3.3 V or +5 V PCI slot, and remove the corresponding expansion slot cover on the back panel of the computer.
5. Gently rock the controller into the slot. The connection may be tight, but do *not* force the controller into place.



Note Check that the bracket of the device aligns with the hole in the back panel rail of the computer chassis.

6. Secure the mounting bracket of the controller to the back panel rail of the computer.
7. Replace the cover.



Caution Always power on the computer containing the motion controller, and then initialize the controller before you power on the rest of the motion system. Power off the motion system in the reverse order.

8. Plug in and power on the computer.

Step 3: Install Software on and Configure the RT PXI Controller (PXI Motion Controllers Only)



Note This step is only required if you are using a PXI-7330/7340/7350 motion controller and an RT PXI controller. If you are not using an RT PXI controller, skip to the [UMI-7764 and NI ISM-74xx Configuration and Installation](#) section.

Complete the following steps to configure the controller and install software on it.



Note The Measurement & Automation Explorer (MAX) user interface may not match these steps exactly depending on which version of MAX you are using.

1. Boot the NI PXI embedded controller into the real-time operating system. The PXI controller automatically boots into LabVIEW RT Safe Mode when no software is installed. LabVIEW RT Safe Mode loads with the basic real-time operating system and automatically attempts to connect to the network using DHCP. If DHCP is not available, the controller connects to the network with a link-local IP address.



Tip You can connect a monitor to the PXI to display startup messages such as the IP address and MAC address.

2. Launch Measurement & Automation Explorer (MAX) on the development computer by clicking the MAX icon on the desktop () , or by selecting **Start»All Programs»National Instruments»Measurement & Automation**.
3. Expand the **Remote Systems** branch. MAX lists the PXI controller as the model name of the controller followed by the MAC address (for example, **NI-PXI-8104 00802f108562**).



Tip Record the PXI controller MAC address, located on the side of the controller, for use in identifying the controller. The label also can be removed and placed on the front of the controller for easier access. If you have connected the PXI controller to a monitor, the MAC address also appears when the PXI system boots up.

4. Select the **System Settings** tab and type a descriptive name for the system in the **Name** field.
5. (Optional) Complete this step only if the target has an empty IP address (0.0.0.0). Select the **Network Settings** tab and select **DHCP or Link Local** from the **Configure IPv4 Address**

list to assign an IP address or select **Static** to specify a static IP address in the **IPv4 Address** section.

6. Click **Save** on the toolbar and let MAX reboot the system.
7. When the new system name appears under **Remote Systems**, expand the controller item in the tree, right-click **Software**, and select **Add/Remove Software**.
8. Install the LabVIEW Real-Time software and NI-Motion on the RT target. Go to ni.com/info and enter `etspc` for the latest information about supported software.
9. Click **Next** to install the selected software on the controller. Click **Help** if you need information about installing recommended software sets.
10. Wait for installation to complete, then click **Finish**.
11. Expand the **Devices and Interfaces** item under the PXI system.
12. Right-click the remote motion controller icon and select **Map to Local Machine**. This assigns a local board ID to the remote motion controller in the host system.

Mapping the remote controller into the local system allows you to configure the controller through MAX exactly as you would a controller that is in the host system. You can initialize the controller, download firmware, and use the interactive and configuration panels exactly as you would on a controller installed in the host machine. You also can write VIs using the remote motion controller through the local board ID assigned to it.

This allows you to write and debug your VIs on the host, and then download them to the remote system when you are ready. All you need to change is the board ID in your VI from the locally assigned Board ID to the ID assigned by the remote system.

13. Browse to **Devices and Interfaces** under **My System**, where there is a shortcut icon next to a new controller name.

For example, if the motion controller on the remote system is a PXI-7354, and the remote system has an IP address of `123.45.678.9`, then the shortcut device would show a name like **PXI-7354 (X) on 123.45.678.9 (Y)**.

X is the board ID assigned to the board by the remote system. Use this board ID for VIs that are downloaded to the remote system through LabVIEW RT.

Y is the board ID assigned to the remote motion controller by the local system. Use this board ID for any VIs that run on the host and use the remote motion controller.

14. Close MAX.

UMI-7764 and NI ISM-74xx Configuration and Installation

This section covers the hardware setup for the NI UMI-7764 and NI ISM-74xx integrated steppers.

Step 1: Connect and Configure the NI UMI-7764

Complete the following steps to connect and configure your UMI-7764.



Tip For more information about connecting external power, encoders, and other motion I/O signals, refer to the *Universal Motion Interface (UMI)-7764 User Guide and Specifications*.

1. Connect the SH68-C68-S 68-pin shielded cable between the Motion I/O connector on the NI 73xx motion controller and the Motion I/O connector on the UMI-7764.
2. Configure the UMI-7764 DIP switches. You must set the DIP switches to the following settings to match the polarity configuration for the integrated steppers:
 - Inhibit Input (S2)—Active Low
 - Inhibit Output (S1)—Active Low

The UMI-7764 DIP switch configuration is shown in Figure 12.

Figure 12. UMI-7764 Inhibit Input and Inhibit Output DIP Switch Settings

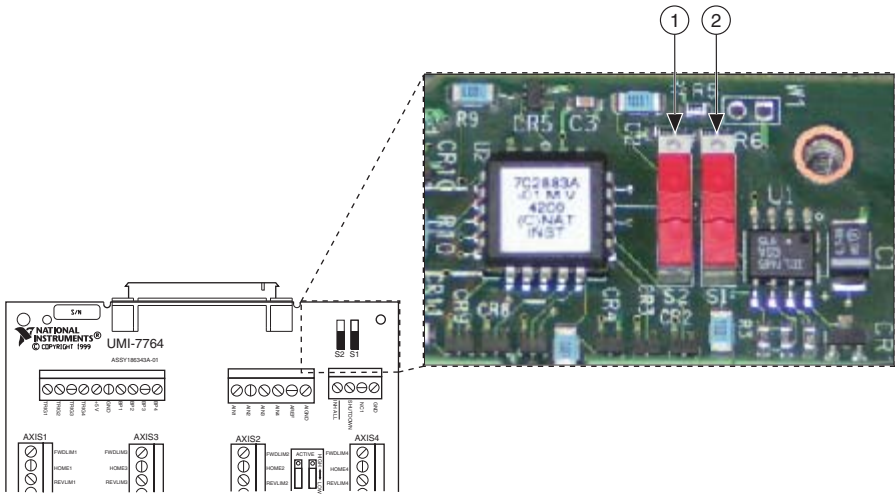

1 Inhibit Input Polarity Switch (S2)

2 Inhibit Output Polarity Switch (S1)

3. Connect an external +5 V power supply to the UMI-7764 Power Input Terminal Block. This connection is required to power the encoder circuitry that converts differential encoder signals to single-ended signals for the motion controller, as well as to power the UMI-7764 Inhibit Output signals.



Caution Do not plug in or turn on any power to the system until after all hardware connections are complete.

Figure 13 shows the location of the UMI 7764 Power Input Terminal Block.

Figure 13. UMI-7764 Power Input Terminal Block

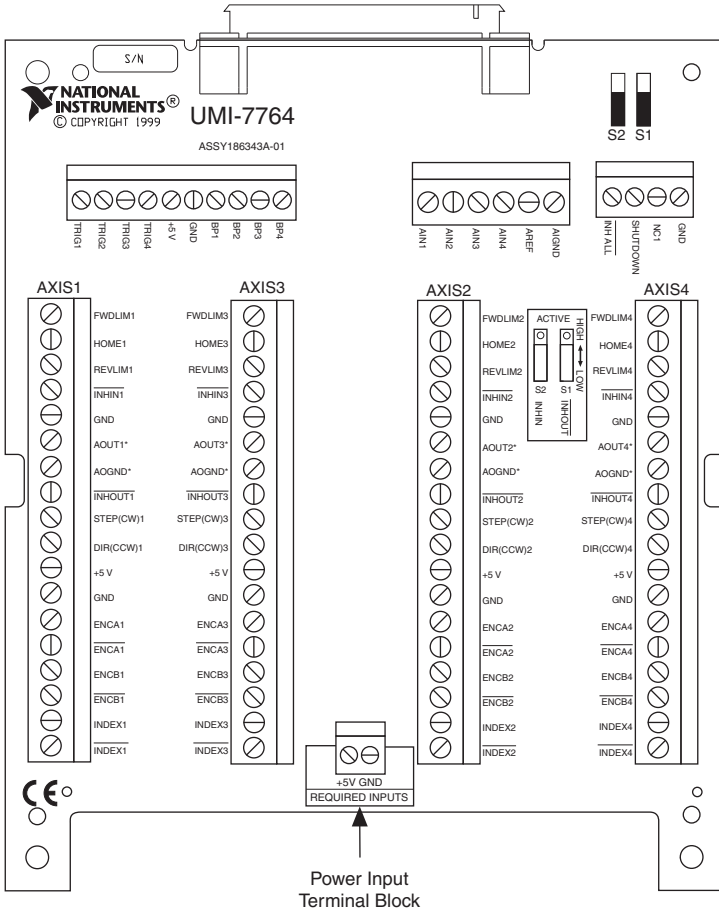

Step 2: Connect the Drive Command Signals to the UMI-7764

Complete the following steps to connect the Drive Command signals to the UMI-7764.

1. Connect the integrated stepper Step- wire (brown) to the Motion I/O terminal block Step (CW)1 terminal.
2. Connect the integrated stepper Dir- wire (green) to the Motion I/O terminal block Direction (CCW)1 terminal.

- Connect the integrated stepper Step+ wire (orange) and Dir+ wire (yellow) to the Motion I/O terminal block +5V terminal.

Figure 14 shows the connections.

Figure 14. NI ISM-7400/7401/7402 to UMI-7764 Drive Command Connections

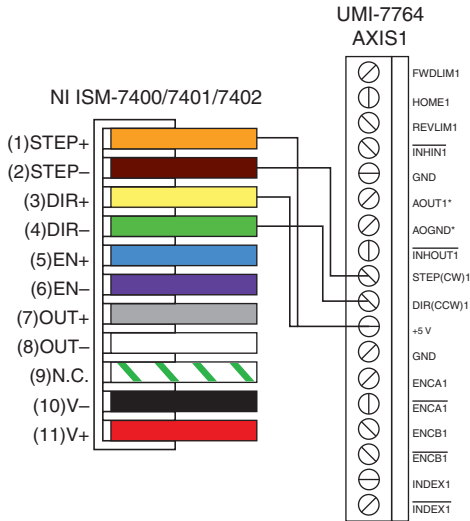
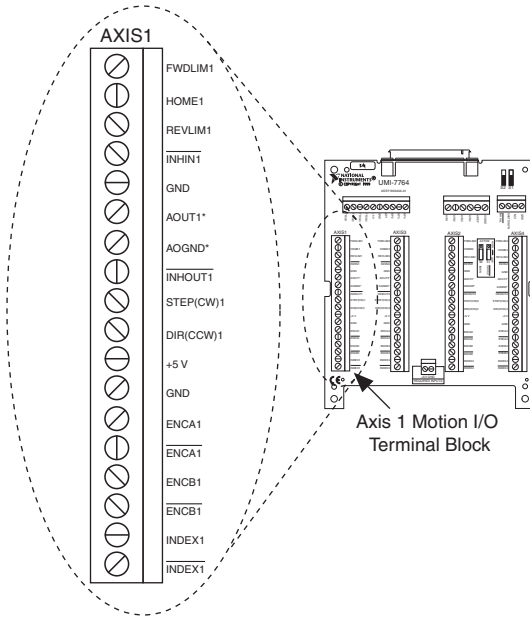

Figure 15 shows the UMI-7764 Motion I/O terminal block location and pinout.

Figure 15. UMI-7764 Motion I/O Terminal Block



Step 3: Connect the Drive Enable Signal to the UMI-7764

Complete the following steps to connect the Drive Enable signal, which controls the enable function of the drive.

1. Connect the En- wire (purple) to the Motion I/O terminal block $\overline{\text{INHOUT1}}$ terminal.
2. Connect the En+ wire (blue) to the Motion I/O terminal block +5V terminal.

Figure 16 shows the connections.

Figure 16. NI ISM-7400/7401/7402 to UMI-7764 Cable Drive Enable Connections

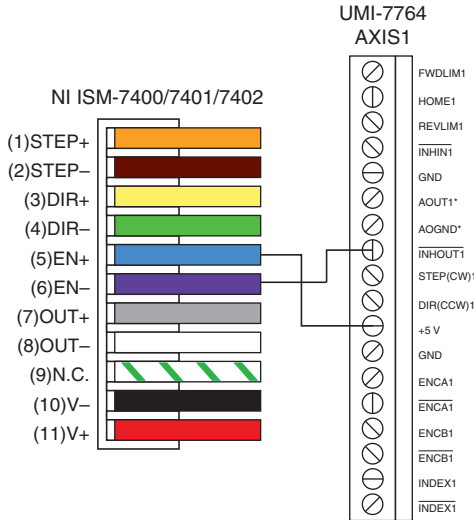

Step 4: (Optional) Connect the Drive Fault Signal to the UMI-7764

Complete the following optional steps to connect the drive fault signal to monitor the NI integrated stepper for faults.



Note If you do not connect the Out+ and Out- signals to the UMI-7764, insulate the wires.

1. Connect the Out+ wire (grey) to the Motion I/O terminal block $\overline{\text{INHIN1}}$ terminal.
2. Connect the Out- wire (white) to the Motion I/O terminal block GND terminal.

Figure 17 shows the connections.

Figure 17. NI ISM-7400/7401/7402 to UMI-7764 Cable Drive Fault Connections

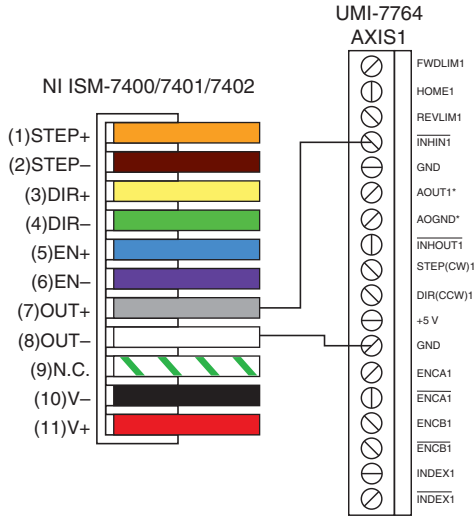

Step 5: (Optional) Connect the Encoder Signals to the UMI-7764

If your NI ISM includes an encoder, connect the encoder signals to the UMI-7764.

1. Connect the encoder cable to the integrated stepper using the included connector.
2. Connect the encoder wires to the UM-7764 Motion I/O terminal block as indicated in Table 3.

Table 3. NI ISM to UMI-7764 Motion I/O Terminal Block Connections

NI ISM Signal Name	Wire Color	Motion I/O Terminal Block Signal Name
A	blue	ENCA1
\bar{A}	blue/white	$\overline{\text{ENCA1}}$
B	brown	ENCB1
\bar{B}	brown/white	$\overline{\text{ENCB1}}$
I	orange	INDEX1
\bar{I}	orange/white	$\overline{\text{INDEX1}}$
GND	green/white	GND
+5V	green	+5 V

Step 6: Connect the NI PS-12/13 Power Supply



Note Do not plug in or turn on the power supply until after you complete [Step 9: Power on the Drive and Verify Connections](#).

Complete the following steps to connect the power supply to AC input power and to the NI integrated stepper. Figure 18 shows the power supply terminals.

Figure 18. NI PS-12/13 Power Supply Terminals

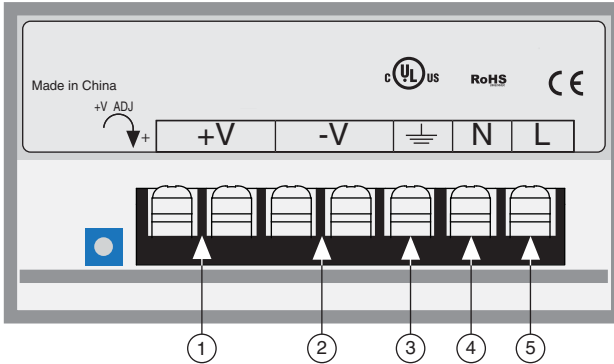

1	+24 V (NI PS-12) or +48 V (NI PS-13) Output	4	AC Input Neutral
2	+24 V (NI PS-12) or +48 V (NI PS-13) Ground	5	AC Input Line
3	AC Input Ground (Protective Earth)		

1. Connect the an AC input cable to the line, neutral, and ground connectors.
2. Connect the integrated stepper V+ (red) wire to the power supply +V connector.
3. Connect the integrated stepper V- (black) wire to the power supply -V connector.
4. Connect the NI UMI power supply ground/common terminal and NI PS-12/13 power supply ground connections to ensure a common reference.

Step 7: Configure the NI ISM-7400/7401/7402 DIP Switches

The NI ISM-7400/7401/7402 integrated steppers provide drive configuration DIP switches. Refer to the *NI ISM-7400/7401/7402 User Manual* for more information about the DIP switch options. The following figure shows the DIP switch location and functions.



Note If you change the DIP switch settings you must power cycle the NI ISM for the new settings to take effect.

Figure 19. NI ISM-7400/7401/7402 DIP Switches

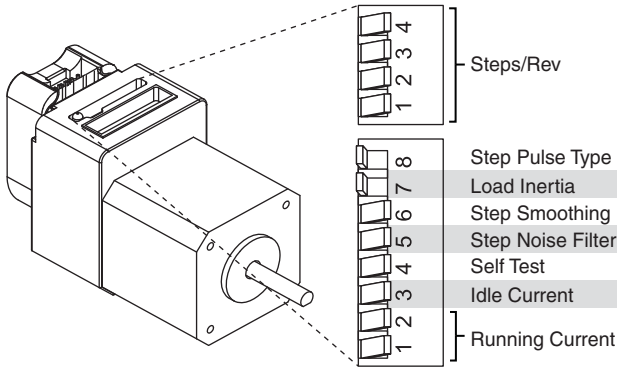

Refer to Table 4 for the DIP switch settings that this document uses.

Table 4. DIP Switch Settings







Setting Name	Switch Position	Corresponding Value
Running Current		100%
Idle Current		50%
Self Test		Off

Table 4. DIP Switch Settings (Continued)

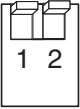
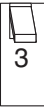
Setting Name	Switch Position	Corresponding Value
Step Noise Filter	 A single DIP switch labeled with the number 5.	2 MHz
Step Smoothing Filter	 A single DIP switch labeled with the number 6.	Off
Load Inertia	 A single DIP switch labeled with the number 7.	0 - 4X
Step Pulse Type	 A single DIP switch labeled with the number 8.	Step/Dir
Step Size	 Four DIP switches labeled 1, 2, 3, and 4.	25000

Step 8: Cut Off and Insulate the NC Wire

The NC wire on the NI ISM-7400/7401/7402 is unused. NI recommends removing and insulating this wire for optimal operation.

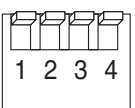
1. Cut off the NC wire.
2. Insulate the end of the wire if there is any exposed metal remaining.

Step 9: Power on the Drive and Verify Connections

After all hardware connections have been made complete the following steps to confirm the hardware setup.

1. Turn on all power supplies.
2. Verify that the Drive Status LED on the NI ISM flashes or is solid green. Figure 20 shows the location of the Drive Status LED.

Figure 20. Drive Status LED Location

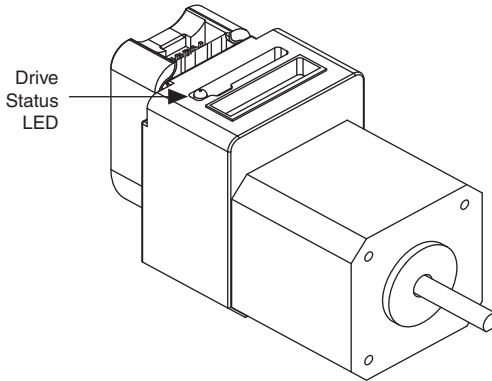

If the Drive Status LED does not flash or turn solid green, turn off all power, verify the connections, and try again.



Software Installation and Configuration

This section covers installing and configuring the software for the NI 7330/7340/7350 motion controller.

Step 1: Update Firmware on the Motion Controller

Firmware is software that is loaded onto the motion controller. Firmware allows you to update the motion controller with new features and updates. The latest firmware is automatically installed on the computer when you install the latest version of NI-Motion. You must download the firmware to the motion controller.

Complete the following steps to download firmware to an NI motion controller:

1. Click the MAX icon on the desktop (), or select **Start»All Programs»National Instruments»Measurement & Automation** to open MAX.
2. Expand **Devices and Interfaces**, and then expand **NI Motion Devices** in the configuration tree.
3. Select the motion controller for which you want to download firmware. An exclamation point on the NI 7330/7340/7350 motion controller icon () indicates that the firmware is outdated and must be updated.

4. Click the **Firmware** tab at the bottom of the window. An exclamation point appears for each firmware sector that requires an update.
5. Click the **Update Firmware** button at the top of the window to update all the firmware files on your device.

Step 2: Configure the NI Motion Controller

Complete the following steps to configure the NI 7330/7340/7350 motion controller for use with the integrated steppers.

1. Open MAX, if it is not already open.
2. Expand **Devices and Interfaces**, expand **NI Motion Devices**, and then select the appropriate motion controller in the configuration tree.
3. Expand the NI motion controller configuration tree item and click **Default 73xx Settings**.
4. Select **Open Loop Stepper** from the **Default Configurations** section.
5. Expand **Default 73xx Settings**, and then expand the axis associated with the integrated steppers.
6. Click **Axis Configuration** and set **Type** to **Stepper**.
7. Click the **Stepper Settings** tab on the bottom of the window and set **Stepper steps per revolution** to 25,000.



Note The **Stepper steps per revolution** setting *must* match the Step Size DIP switch setting on the NI ISM. If you change the Step Size setting using the DIP switches, update this setting to match.

8. Click **Motion I/O Settings** and select **Disabled** for the **Forward Limit Switch**, **Reverse Limit Switch**, and **Home Switch**.



Note These configuration settings disable limits for initial setup and testing purposes. National Instruments recommends connecting and enabling limits in your final application.

9. Set the limit and home input active state. This prevents the limit active error from occurring when no limits are connected.
 - a. **UMI-7764**—Active Low Polarity
 - b. **UMI-7772/7774**—Active High Polarity
10. Set **Inhibit Output Settings** to **Active Low Polarity**.
11. (Optional) Click **Encoder Settings**.
 - a. In the **Polarities** section confirm that the **Line State** for **A**, **B**, and **Index** is set to **Active High**.
 - b. In the **Index Reference Criteria** section confirm that the **Line State** for **A** and **B** is set to **Inactive**.

- c. Set Encoder counts per revolution to 4,000. This setting is the encoder resolution in quadrature counts per revolution and corresponds to the encoder lines per revolution multiplied by four.
12. Click **Initialize** on the toolbar to send the updated settings to the motion controller. Initializing the motion controller resets it to a known starting state so that it is ready for commands.

Step 3: Test the Motor In MAX

You will now move the motor using the NI motion controller and MAX. Select the **1-D Interactive** panel in the Configuration tree and change the settings to match those shown in Figure 21. Change the axis if you are not using Axis 1.

Figure 21. 1-D Interactive Panel Settings

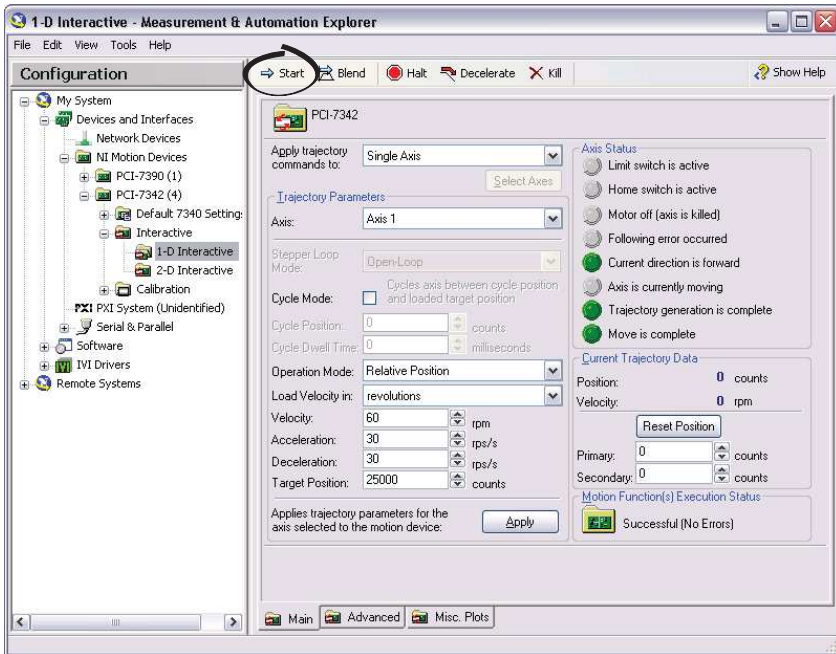

1. Click **Start**. Your motor should rotate 1 time at 60 rpm.
2. Finalize your motion system setup by connecting and configuring additional I/O such as limits as required by your application.
 - If using the UMI-7764, use the available screw-terminal connections on the same axis terminal block as the integrated steppers connections.
 - If using the UMI-7772/7774, use the DB9M, DB15M, and DB25M pigtail cables.

Where to Go Next

The following documents contain additional information that you may find helpful. All referenced documents ship with the product and are available at ni.com/manuals.

- *NI 7330 User Manual, NI 7340 User Manual, or NI 7350 User Manual*—Describes the electrical and mechanical aspects of the NI 7330/7340/7350 motion controller, and contains information about installing and operating the device.
- *Getting Started with NI-Motion for NI 73xx Motion Controllers*—Provides instructions for installing and getting started with the NI-Motion driver software and NI motion controllers.
- *NI ISM-74xx Hardware Manual*
- *NI-Motion Help*—Contains information about designing a basic move, designing a multi-axis move, incorporating image and data acquisition into motion applications, and working with common motion concepts, such as contouring and breakpoints. This document is task-based and takes you through each phase of designing and executing a motion application.
- *NI-Motion Function Help*—Contains function reference information for C and Visual Basic and provides details about each function, including a description of the function, a list of the function parameters, illustrations, and error codes.
- *NI-Motion VI Help*—Contains LabVIEW VI reference information and provides details about each VI, including VI descriptions, lists of VI parameters, usage, illustrations, and error codes.
- *Measurement & Automation Explorer Help for Motion*—Provides information about using MAX to configure the NI motion controller as well as advanced conceptual information about topics such as Bode analysis and control loop parameters.
- *Getting Started with LabVIEW*—Use this document as a tutorial to familiarize yourself with the LabVIEW graphical programming environment and the basic LabVIEW features you use to build data acquisition and instrument control applications. Access the *Getting Started with LabVIEW* PDF by selecting **Start»All Programs»National Instruments»LabVIEW»LabVIEW Manuals»LV_Getting_Started.pdf**.

Worldwide Support and Services

The National Instruments Web site is your complete resource for technical support. At ni.com/support you have access to everything from troubleshooting and application development self-help resources to email and phone assistance from NI Application Engineers.

Visit ni.com/services for NI Factory Installation Services, repairs, extended warranty, calibration, and other services.

Visit ni.com/register to register your National Instruments product. Product registration facilitates technical support and ensures that you receive important information updates from NI.

A Declaration of Conformity (DoC) is our claim of compliance with the Council of the European Communities using the manufacturer's declaration of conformity. This system affords the user protection for electromagnetic compatibility (EMC) and product safety. You can obtain the DoC for your product by visiting ni.com/certification. If your product supports calibration, you can obtain the calibration certificate for your product at ni.com/calibration.

National Instruments corporate headquarters is located at 11500 North Mopac Expressway, Austin, Texas, 78759-3504. National Instruments also has offices located around the world to help address your support needs. For telephone support in the United States, create your service request at ni.com/support and follow the calling instructions or dial 512 795 8248. For telephone support outside the United States, visit the Worldwide Offices section of ni.com/niglobal to access the branch office Web sites, which provide up-to-date contact information, support phone numbers, email addresses, and current events.

Refer to the *NI Trademarks and Logo Guidelines* at ni.com/trademarks for more information on National Instruments trademarks. Other product and company names mentioned herein are trademarks or trade names of their respective companies. For patents covering National Instruments products/technology, refer to the appropriate location: **Help»Patents** in your software, the `patents.txt` file on your media, or the *National Instruments Patents Notice* at ni.com/patents. You can find information about end-user license agreements (EULAs) and third-party legal notices in the `readme` file for your NI product. Refer to the *Export Compliance Information* at ni.com/legal/export-compliance for the National Instruments global trade compliance policy and how to obtain relevant HTS codes, ECCNs, and other import/export data.

© 2013 National Instruments. All rights reserved.