

COMPREHENSIVE SERVICES

We offer competitive repair and calibration services, as well as easily accessible documentation and free downloadable resources.

SELL YOUR SURPLUS

We buy new, used, decommissioned, and surplus parts from every NI series. We work out the best solution to suit your individual needs.

 Sell For Cash  Get Credit  Receive a Trade-In Deal

OBSOLETE NI HARDWARE IN STOCK & READY TO SHIP

We stock **New**, **New Surplus**, **Refurbished**, and **Reconditioned** NI Hardware.



Bridging the gap between the manufacturer and your legacy test system.

 1-800-915-6216

 www.apexwaves.com

 sales@apexwaves.com

All trademarks, brands, and brand names are the property of their respective owners.

Request a Quote

 **CLICK HERE**

USB-6341

NOTE TO USERS

Ferrite Installation

NI USB X Series BNC and Mass Termination Devices

To ensure the specified EMC performance for radiated RF emissions of the NI USB X Series BNC and Mass Termination devices, install the included snap-on ferrite bead onto the power cable, as shown in the following figure.

Ensure that the ferrite bead is as close to the end of the power cable as practical. Install the snap-on ferrite bead by opening the housing and looping the power cable once through the center of the ferrite. Close the ferrite bead until the locking tabs engage securely.

You can order additional EMI suppression ferrites, 10.2 mm length (part number 781233-02) from NI.



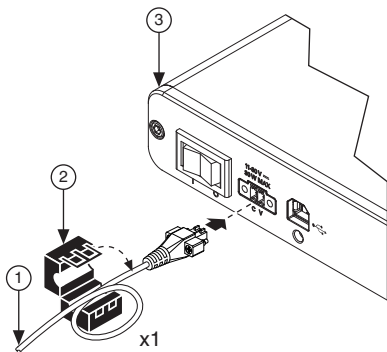

1 Power Cable

3 NI USB X Series Device

2 Ferrite

LabVIEW, National Instruments, NI, ni.com, the National Instruments corporate logo, and the Eagle logo are trademarks of National Instruments Corporation. Refer to the *Trademark Information* at ni.com/trademarks for other National Instruments trademarks. Other product and company names mentioned herein are trademarks or trade names of their respective companies. For patents covering National Instruments products/technology, refer to the appropriate location: **Help»Patents** in your software, the `patents.txt` file on your media, or the *National Instruments Patent Notice* at ni.com/patents. Refer to the *Export Compliance Information* at ni.com/legal/export-compliance for the National Instruments global trade compliance policy and how to obtain relevant HTS codes, ECCNs, and other import/export data.

© 2012 National Instruments Corp. All rights reserved.