

COMPREHENSIVE SERVICES

We offer competitive repair and calibration services, as well as easily accessible documentation and free downloadable resources.

SELL YOUR SURPLUS

We buy new, used, decommissioned, and surplus parts from every NI series. We work out the best solution to suit your individual needs.

 Sell For Cash  Get Credit  Receive a Trade-In Deal

OBSOLETE NI HARDWARE IN STOCK & READY TO SHIP

We stock **New**, **New Surplus**, **Refurbished**, and **Reconditioned** NI Hardware.



Bridging the gap between the manufacturer and your legacy test system.

 1-800-915-6216

 www.apexwaves.com

 sales@apexwaves.com

All trademarks, brands, and brand names are the property of their respective owners.

Request a Quote

 **CLICK HERE**

USB-6343

USER GUIDE

Locking Lid For USB Screw Terminal Devices

USB X Series Screw Terminal Devices

You can provide additional security and ruggedness to the USB X Series Screw Terminal devices by using a lid with integrated thumb and screw locks (part number 781661-01, not included in your USB X Series device kit). This lid allows you to strengthen the holding force beyond the included magnets by screwing it finger tight, or using a screwdriver to lock it down for additional security.

To install the locking lid, place it into the enclosure recess and thread the captive thumbscrews into the corresponding holes of the enclosure by hand, as shown in Figure 1. Tighten further with a #1 Phillips screwdriver to require tool access to the screw terminals.



Figure 1. Installing the Locking Lid

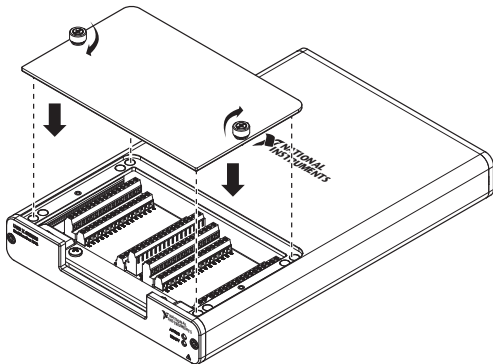

Refer to the *NI Trademarks and Logo Guidelines* at ni.com/trademarks for more information on National Instruments trademarks. Other product and company names mentioned herein are trademarks or trade names of their respective companies. For patents covering National Instruments products/technology, refer to the appropriate location: **Help»Patents** in your software, the `patents.txt` file on your media, or the *National Instruments Patent Notice* at ni.com/patents. You can find information about end-user license agreements (EULAs) and third-party legal notices in the readme file for your NI product. Refer to the *Export Compliance Information* at ni.com/legal/export-compliance for the National Instruments global trade compliance policy and how to obtain relevant HTS codes, ECCNs, and other import/export data. NI MAKES NO EXPRESS OR IMPLIED WARRANTIES AS TO THE ACCURACY OF THE INFORMATION CONTAINED HEREIN AND SHALL NOT BE LIABLE FOR ANY ERRORS. U.S. Government Customers: The data contained in this manual was developed at private expense and is subject to the applicable limited rights and restricted data rights as set forth in FAR 52.227-14s, DFAR 252.227-7014, and DFAR 252.227-7015.

© 2014 National Instruments. All rights reserved.