

COMPREHENSIVE SERVICES

We offer competitive repair and calibration services, as well as easily accessible documentation and free downloadable resources.

SELL YOUR SURPLUS

We buy new, used, decommissioned, and surplus parts from every NI series. We work out the best solution to suit your individual needs.

 Sell For Cash  Get Credit  Receive a Trade-In Deal

OBSOLETE NI HARDWARE IN STOCK & READY TO SHIP

We stock **New**, **New Surplus**, **Refurbished**, and **Reconditioned** NI Hardware.



Bridging the gap between the manufacturer and your legacy test system.

 1-800-915-6216

 www.apexwaves.com

 sales@apexwaves.com

All trademarks, brands, and brand names are the property of their respective owners.

Request a Quote

 **CLICK HERE**

cDAQ-9178

Industrial Rack Mount Kit for CompactRIO and CompactDAQ

The National Instruments Industrial Rack Mount Kit for CompactRIO and CompactDAQ is an accessory you can use to mount a CompactRIO or CompactDAQ controller and chassis, or an MXI-Express RIO Chassis on a standard 19-inch rack. You can use the Industrial Rack Mount Kit to directly mount a single controller or chassis in a 3U form factor.



Note If you are mounting a cDAQ-9179 chassis to the Industrial Rack Mount Kit you need a standard DIN rail (not provided) and an NI 9916 DIN Rail Kit. If you are mounting a cDAQ-9181/9191 chassis to the Industrial Rack Mount Kit you need a standard DIN rail (not provided) and an NI 9913 DIN Rail Kit.

The Industrial Rack Mount Kit for CompactRIO and CompactDAQ contains the following components:

Figure 1. Industrial Rack Mount for CompactRIO and CompactDAQ Components

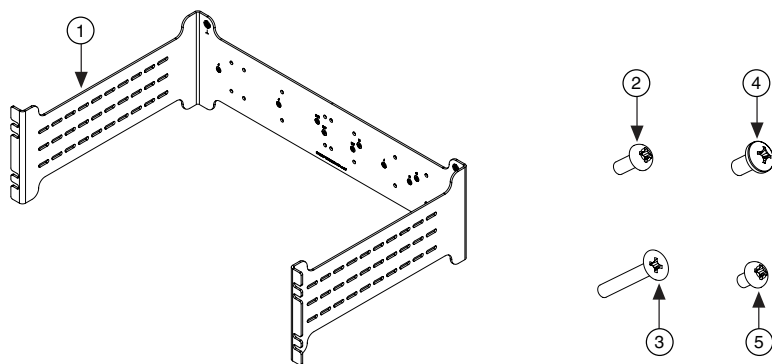

- | | |
|--|---------------------------------------|
| 1. Industrial Rack Mount for CompactRIO and CompactDAQ | 4. #10-32 x 3/8 in. Panhead Screw (4) |
| 2. M4 x 10 mm Panhead Screw (6) | 5. M4 x 6 mm Panhead Screw (2) |
| 3. M4 x 25 mm Flathead Screw (3) | |

Figure 2. Industrial Rack Mount for CompactRIO and CompactDAQ Dimensions

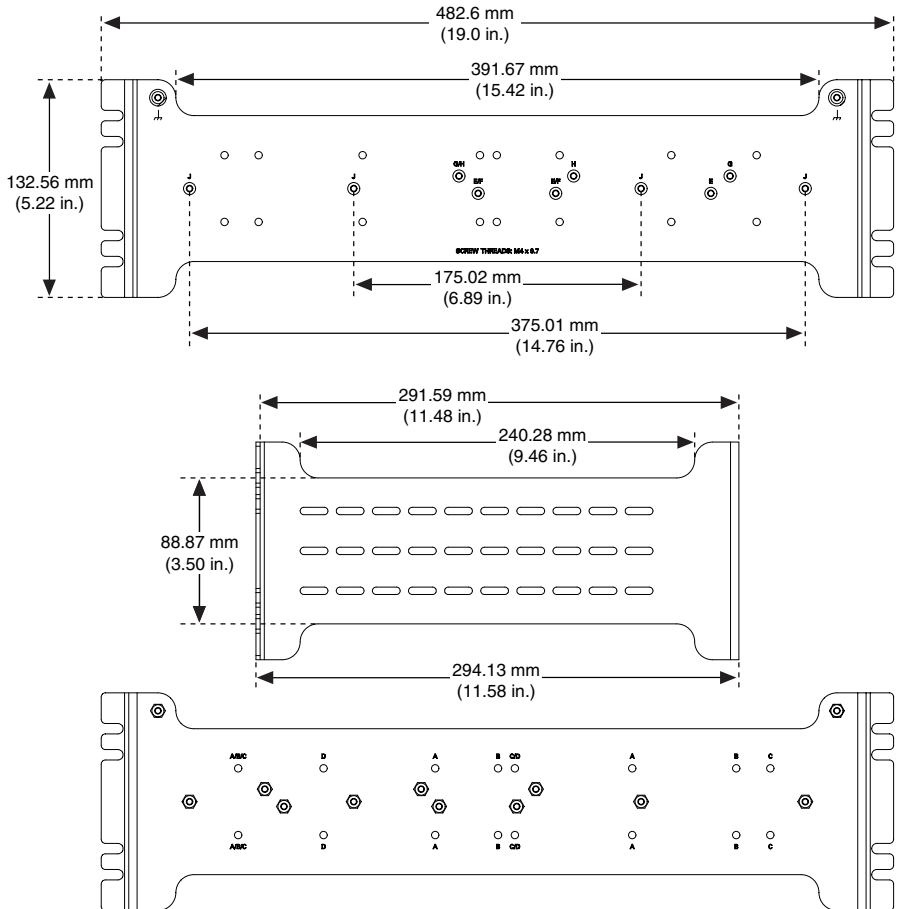

Installing the Industrial Rack Mount Kit

You need a #2 Phillips screwdriver to install the Industrial Rack Mount Kit for CompactRIO and CompactDAQ.

Complete the following steps to install the Industrial Rack Mount Kit on a standard 19-inch rack:

1. Locate your controller or chassis' designated mounting holes on the Industrial Rack Mount by first finding your controller in [Appendix A: Rack Mount Kit Hole Patterns](#). Then locate all holes on the Industrial Rack Mount that are marked with the letter corresponding to your model.

2. Attach the controller or chassis to the Industrial Rack Mount using the hole pattern identified in step 1. Tighten the screws to a maximum torque of $1.3 \text{ N} \cdot \text{m}$ (11.5 lb. in).

(Front mounting controller or chassis) Use either two or three, depending on your controller or chassis, of the M4 x 25 mm flathead screws, included in the kit. Refer to Figure 3.

(Rear mounting controller or chassis) Use either four or six, depending on your controller or chassis or chassis, of the M4 x 10 mm panhead screws, included in the kit. Refer to Figure 4.

Figure 3. Attaching a Front Mounting Controller or Chassis to the Industrial Rack Mount for CompactRIO and CompactDAQ

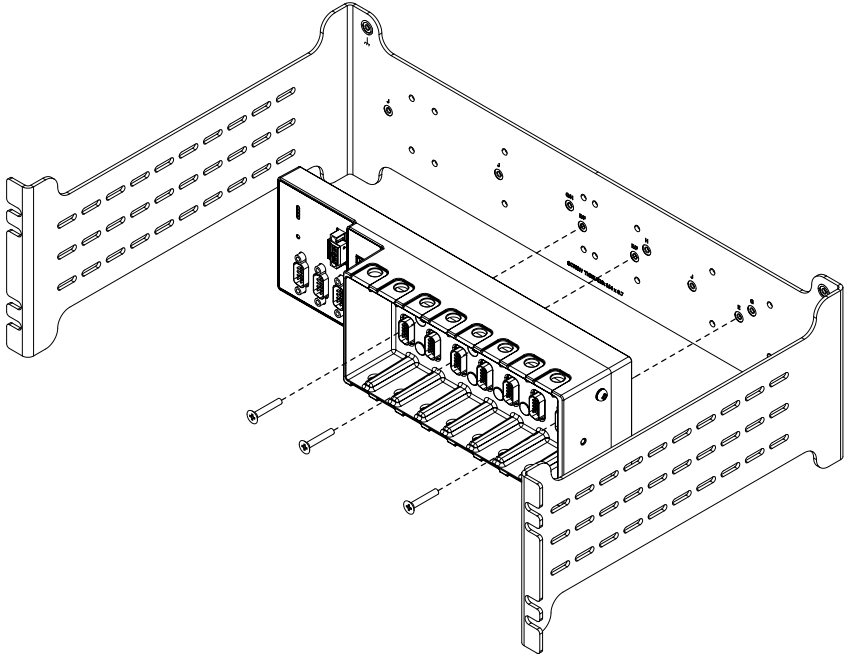
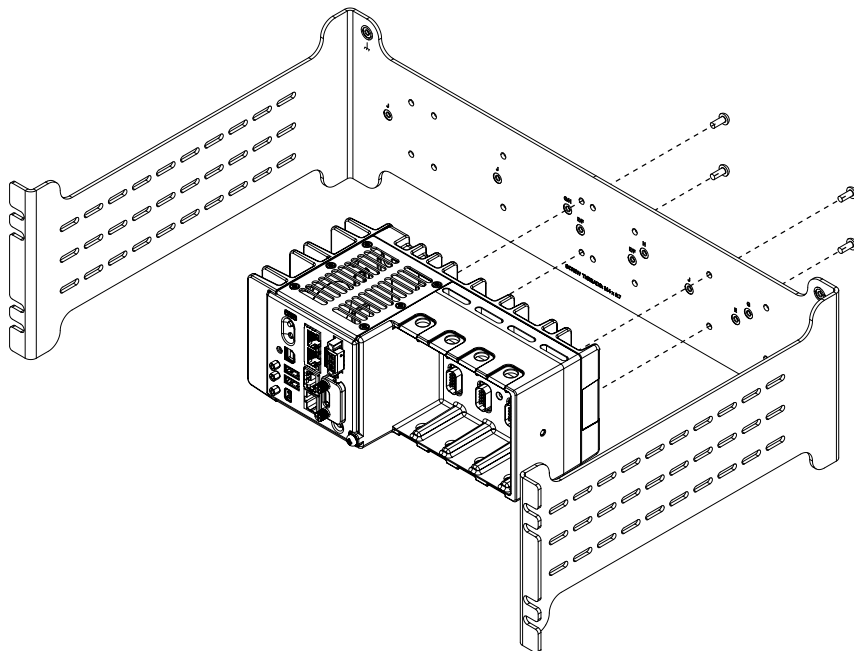
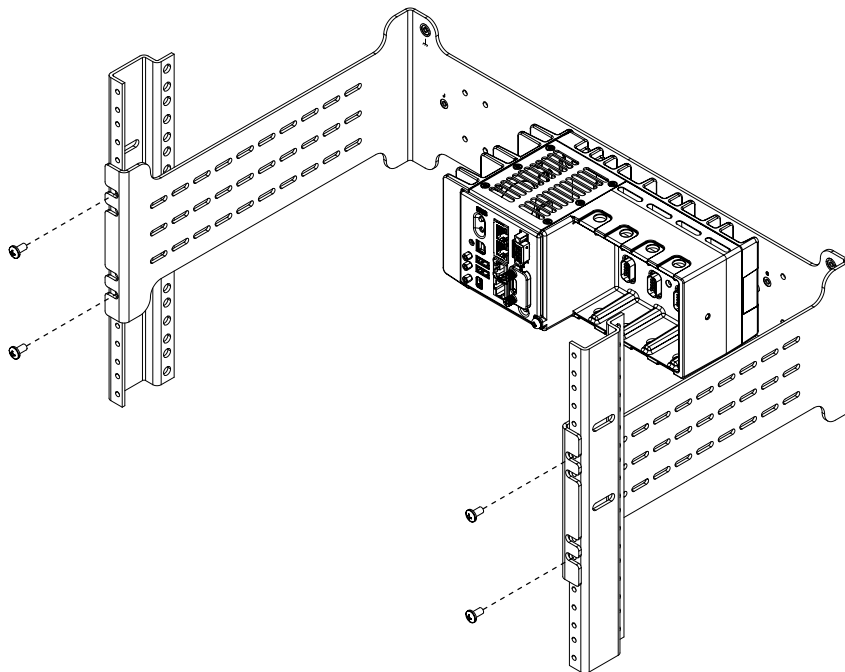

Figure 4. Attaching a Rear Mounting Controller or Chassis to the Industrial Rack Mount for CompactRIO and CompactDAQ



3. Attach the Industrial Rack Mount for CompactRIO and CompactDAQ to a standard 19-inch rack using four #10-32 x 3/8 in. panhead screws, included in the kit. Refer to Figure 5.

Figure 5. Attaching the Industrial Rack Mount for CompactRIO and CompactDAQ to a 19-inch Rack



Note The two M4 x 6 mm panhead screws, included in the kit, can be used to attach chassis ground leads to two grounding locations provided on the Industrial Rack Mount.

Optional DIN Rail Mounting with the Industrial Rack Mount Kit

The Industrial Rack Mount Kit for CompactRIO and CompactDAQ can be used to install DIN rail mountable equipment on a standard 19-inch rack. To do this, a DIN rail (17 in. maximum length) is required. This DIN rail component is not provided with the kit.

Complete the following to prepare the Industrial Rack Mount Kit for DIN rail mounting.

1. Locate the hole pattern on the Industrial Rack Mount you wish to use for mounting your DIN rail. National Instruments recommends hole pattern 'J' for most DIN rail mounting applications. Ensure that the selected hole pattern is supported by your DIN rail.
2. Attach the DIN rail to the Industrial Rack Mount using either two or four, depending on your DIN rail length, of the M4 x 10 mm panhead screws, included in the kit. Refer to Figure 6.

Figure 6. Attaching DIN Rail to the Industrial Rack Mount for CompactRIO and CompactDAQ

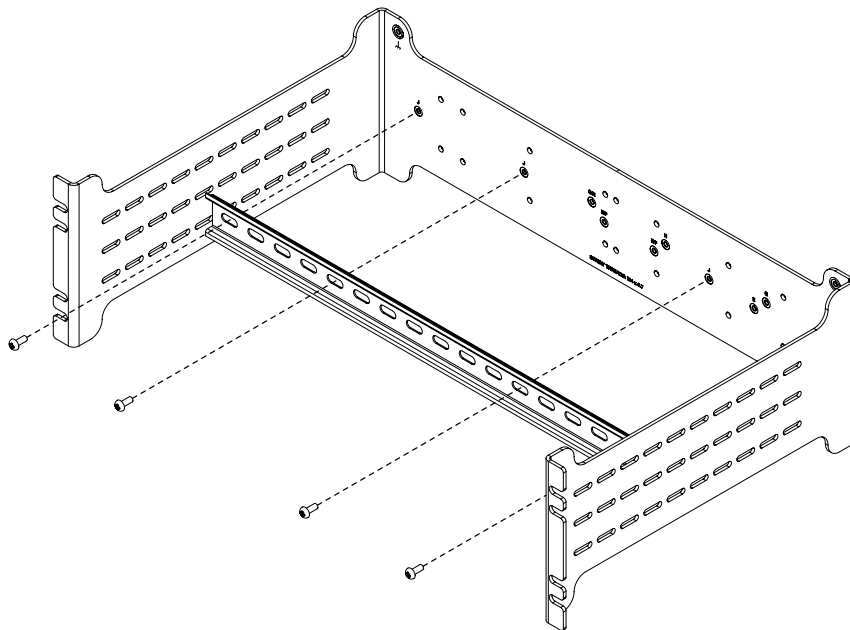

Appendix A: Rack Mount Kit Hole Patterns

If your controller or chassis is not listed in the following table, you can find more models by going to ni.com/info and entering the infocode `RackKit`.

Controller or Chassis	Model	Slot Count	Rack Kit Hole Pattern
CompactRIO Controllers	cRIO-9030	4	D
	cRIO-9031	4	D
	cRIO-9032	4	D
	cRIO-9033	4	D
	cRIO-9034	4	D
	cRIO-9035	8	A
	cRIO-9036	8	A
	cRIO-9037	8	A
	cRIO-9038	8	A
	cRIO-9039	8	A
	cRIO-9040	4	D
	cRIO-9041	4	D
	cRIO-9042	4	D
	cRIO-9043	4	D
	cRIO-9045	8	A
	cRIO-9046	8	A
	cRIO-9047	8	A
	cRIO-9048	8	A
	cRIO-9049	8	A
	cRIO-9063	4	F
	cRIO-9064	4	F
	cRIO-9065	4	F
	cRIO-9066	8	E
	cRIO-9067	8	E
	cRIO-9068	8	E

Controller or Chassis	Model	Slot Count	Rack Kit Hole Pattern
CompactRIO Chassis	NI 9144	8	G
	NI 9145	8	E
	NI 9146	4	F
	NI 9147	4	F
	NI 9149	8	E
	NI 9154	8	G
	NI 9155	8	C (right four holes)
	NI 9157	14	C
	NI 9159	14	C
CompactDAQ Controllers	cDAQ-9132	4	D
	cDAQ-9133	8	A
	cDAQ-9134	4	D
	cDAQ-9135	8	A
	cDAQ-9136	4	D
	cDAQ-9137	8	A
CompactDAQ Chassis	cDAQ-9174	4	H
	cDAQ-9178	8	G
	cDAQ-9179	14	DIN mount only
	cDAQ-9181	1	DIN mount only
	cDAQ-9184	4	F
	cDAQ-9185	4	F
	cDAQ-9188	8	G
	cDAQ-9189	8	E
	cDAQ-9191	1	DIN mount only

Information is subject to change without notice. Refer to the *NI Trademarks and Logo Guidelines* at ni.com/trademarks for information on NI trademarks. Other product and company names mentioned herein are trademarks or trade names of their respective companies. For patents covering NI products/technology, refer to the appropriate location: **Help»Patents** in your software, the `patents.txt` file on your media, or the *National Instruments Patent Notice* at ni.com/patents. You can find information about end-user license agreements (EULAs) and third-party legal notices in the `readme` file for your NI product. Refer to the *Export Compliance Information* at ni.com/legal/export-compliance for the NI global trade compliance policy and how to obtain relevant HTS codes, ECCNs, and other import/export data. NI MAKES NO EXPRESS OR IMPLIED WARRANTIES AS TO THE ACCURACY OF THE INFORMATION CONTAINED HEREIN AND SHALL NOT BE LIABLE FOR ANY ERRORS. U.S. Government Customers: The data contained in this manual was developed at private expense and is subject to the applicable limited rights and restricted data rights as set forth in FAR 52.227-14, DFAR 252.227-7014, and DFAR 252.227-7015.

© 2018 National Instruments. All rights reserved.

377427A-01 January 3, 2018