

## COMPREHENSIVE SERVICES

We offer competitive repair and calibration services, as well as easily accessible documentation and free downloadable resources.

## SELL YOUR SURPLUS

We buy new, used, decommissioned, and surplus parts from every NI series. We work out the best solution to suit your individual needs.

 Sell For Cash  Get Credit  Receive a Trade-In Deal

## OBSOLETE NI HARDWARE IN STOCK & READY TO SHIP

We stock **New, New Surplus, Refurbished, and Reconditioned** NI Hardware.



*Bridging the gap between the manufacturer and your legacy test system.*

 1-800-915-6216

 [www.apexwaves.com](http://www.apexwaves.com)

 [sales@apexwaves.com](mailto:sales@apexwaves.com)

*All trademarks, brands, and brand names are the property of their respective owners.*

**Request a Quote**

 **CLICK HERE**

**cRIO-9024**

# Quick Start Guide: Quanser Q1-cRIO



## STEP 1 Check Components and Details

Make sure your Quanser Q1-cRIO module includes the following components:



1. Quanser Q1-cRIO module
2. RCA to RCA cable (loopback cable)
3. Red and black power leads for Quanser Q1-cRIO
4. User Manual

## STEP 2 Additional Components Required for Set Up

To complete the NI CompactRIO and Quanser Q1-cRIO data acquisition system, you will also need the following components:

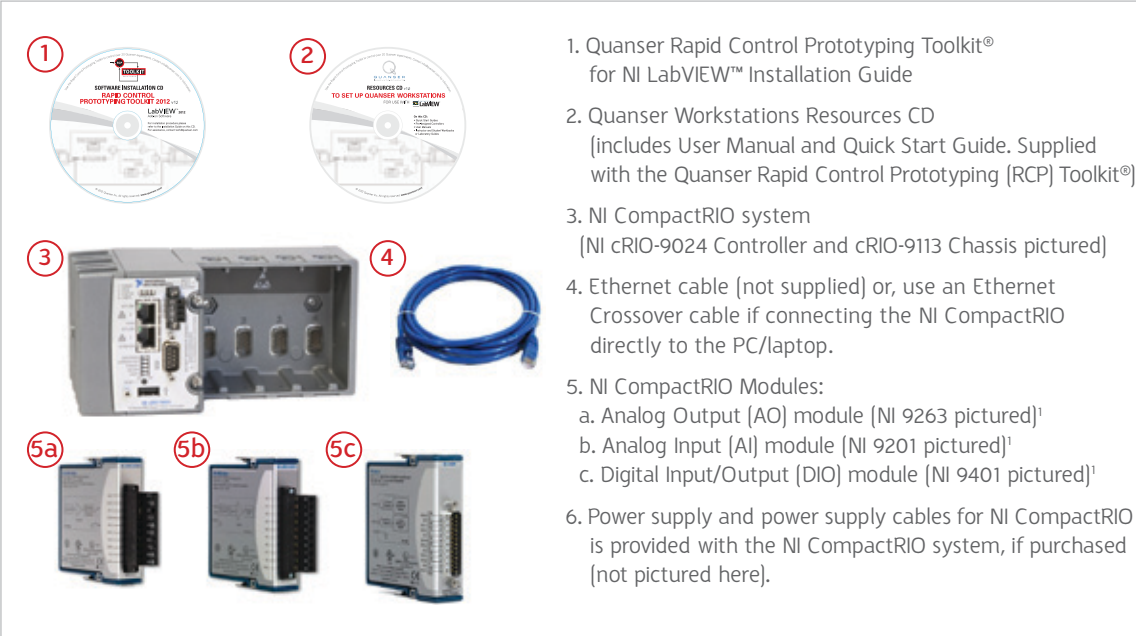

1. Quanser Rapid Control Prototyping Toolkit® for NI LabVIEW™ Installation Guide
2. Quanser Workstations Resources CD (includes User Manual and Quick Start Guide. Supplied with the Quanser Rapid Control Prototyping (RCP) Toolkit®)
3. NI CompactRIO system (NI cRIO-9024 Controller and cRIO-9113 Chassis pictured)
4. Ethernet cable (not supplied) or, use an Ethernet Crossover cable if connecting the NI CompactRIO directly to the PC/laptop.
5. NI CompactRIO Modules:
  - a. Analog Output (AO) module (NI 9263 pictured)<sup>1</sup>
  - b. Analog Input (AI) module (NI 9201 pictured)<sup>1</sup>
  - c. Digital Input/Output (DIO) module (NI 9401 pictured)<sup>1</sup>
6. Power supply and power supply cables for NI CompactRIO is provided with the NI CompactRIO system, if purchased (not pictured here).

<sup>1</sup>Between 0 and 3 NI CompactRIO modules are required depending on the NI CompactRIO configuration used. See the table chart in Step 3C.

### STEP 3 Hardware Setup

To setup for the NI CompactRIO and the Quanser Q1-cRIO module, please read the following instructions carefully. For full details on how to set up the NI CompactRIO hardware, see <http://www.ni.com/gettingstarted/setuphardware/>. For more information on configuring the NI CompactRIO for first-time users, see <http://www.ni.com/gettingstarted/setuphardware/compactrio/firstuse.htm>.

A

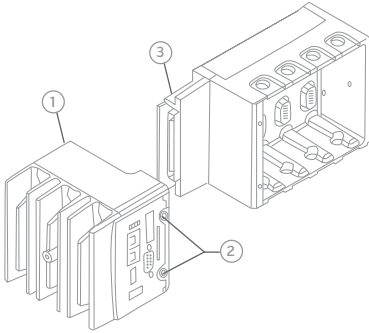

Connect the chassis and controller of your NI CompactRIO hardware together.

1. Slide the controller ① onto the chassis connector ③. Press firmly to ensure the chassis connector and controller connector are mated.
2. Tighten the two captive screws ② on the front of the controller.

B

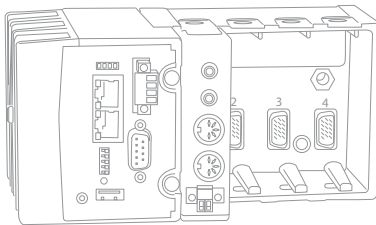

Insert the Quanser Q1-cRIO module in Slot 1 of the NI CompactRIO chassis by squeezing both module latches, placing the Quanser Q1-cRIO module into the empty slot, and pressing until both latches lock the module in place.

C

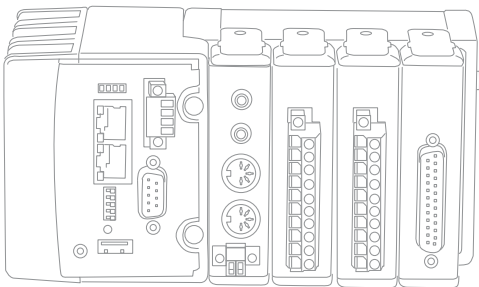

If you are using a single Quanser Q1-cRIO module, insert the following additional NI C Series modules in the NI CompactRIO chassis:

**Slot 2** NI 9263 Analog Output (AO) Module

**Slot 3** NI 9201 Analog Input (AI) Module

**Slot 4** NI 9401 Digital I/O (DIO) Module

To use multiple Quanser Q1-cRIO modules, the Quanser Rapid Control Prototyping Toolkit® supports the following NI CompactRIO configurations:

Slot	1	2	3	4
Q1-Single	Q1	AO	AI	DIO
Q1-Double	Q1	Q1	AI	DIO
Q1-Triple	Q1	Q1	Q1	DIO
Q1-Quad	Q1	Q1	Q1	Q1

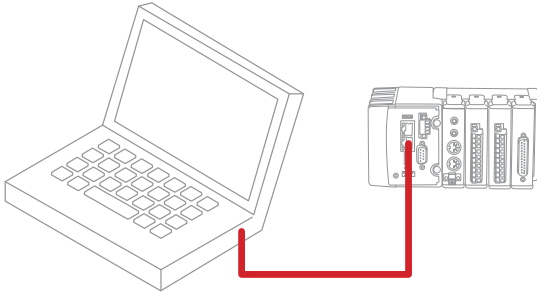
**D**

Using an Ethernet crossover cable, connect the **ACT/LINK** Ethernet connector (either connector 1 or 2) on the NI CompactRIO controller directly to your computer. You can also connect the NI CompactRIO to a network (hub or router) using a standard Ethernet cable.

**E**

**SAFE MODE**  
**CONSOLE OUT**  
**IP RESET**  
**NO APP**  
**USER 1**



Ensure the DIP switches on your NI CompactRIO are all in the OFF position.

**F**

Make sure the power supply you will be using with your NI CompactRIO is OFF.

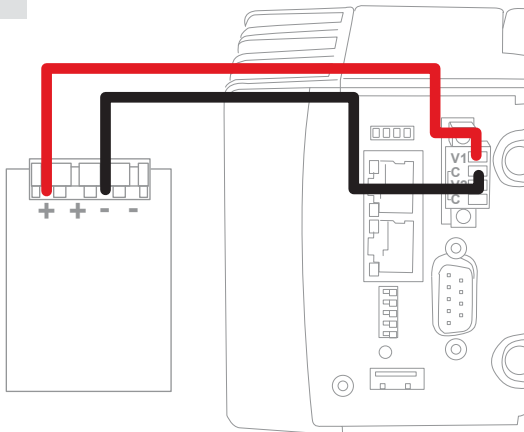
**G**

Connect the power supply to the NI CompactRIO (cRIO) controller:

1. Remove the COMBICON power connector from the NI CompactRIO controller by loosening the two captive screws.
2. Connect the positive lead of the power supply to the V1 terminal and the negative lead to one of the C terminals on the power connector.
3. Tighten the leads in the connector by turning the captive screws on the side of the connector.
4. Re-attach the COMBICON connector on the NI CompactRIO.

# H

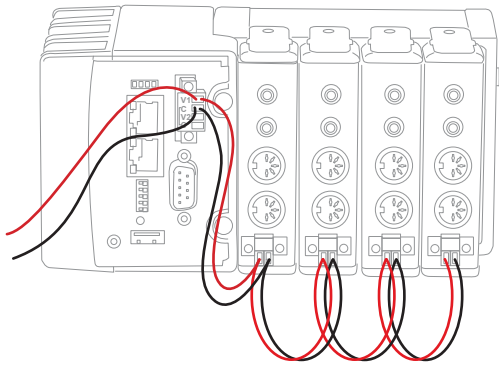

Connect the power terminals on the NI CompactRIO controller to the Quanser Q1-cRIO module as follows:

1. Remove the power connector on the Quanser Q1-cRIO module by loosening the screws.
2. Connect the V1 and C power terminals on the NI CompactRIO controller to the + and - terminals on the Quanser Q1-cRIO module power connector.

**Note:** Make sure you use the V1 terminal that was used in Step 3G for the power supply connection.

3. If using multiple Quanser Q1-cRIO modules, daisy chain the modules by connecting the + terminal from one module to the + terminal on the other. Do the same for the - terminals.
4. Tighten the power cables in the Quanser Q1-cRIO module power connector terminals using the screws.
5. Re-attach the power connector to the Quanser Q1-cRIO module.

**Note:** Make sure the red cable connects to the + terminal and the black connects to the - terminal on each Quanser Q1-cRIO module.

Connect your power supply as instructed in its user manual to turn it ON and power up the NI CompactRIO controller. When first powered the **Power** and **Status** LEDs should both be turned on. Then the **Status** LED should either turn off or blink repeatedly once every few seconds.

## STEP 4 Software Setup

Follow the instructions given in the *Rapid Control Prototyping [RCP] Toolkit® Installation Guide for the NI CompactRIO* (located on the RCP Toolkit Installation CD) to install LabVIEW™, its necessary add-on modules, and the RCP Toolkit on **both your PC/laptop and on the NI CompactRIO**.

## STEP 5 Troubleshooting

See the Troubleshooting section in the *Rapid Control Prototyping [RCP] Toolkit® Installation Guide for the NI CompactRIO* for help with the NI CompactRIO and Quanser Q1-cRIO module. For further details, refer to the troubleshooting guide for the NI CompactRIO device at: <http://www.ni.com/gettingstarted/setuphardware/compactrio/troubleshootmax.htm>

STILL NEED HELP?

For further assistance from a Quanser engineer, contact us at [tech@quanser.com](mailto:tech@quanser.com) or call +1-905-940-3575.

LEARN MORE

To find out about the full range of Quanser control experiments, visit [www.quanser.com](http://www.quanser.com)