

COMPREHENSIVE SERVICES

We offer competitive repair and calibration services, as well as easily accessible documentation and free downloadable resources.

SELL YOUR SURPLUS

We buy new, used, decommissioned, and surplus parts from every NI series. We work out the best solution to suit your individual needs.

 Sell For Cash  Get Credit  Receive a Trade-In Deal

OBSOLETE NI HARDWARE IN STOCK & READY TO SHIP

We stock **New**, **New Surplus**, **Refurbished**, and **Reconditioned** NI Hardware.



Bridging the gap between the manufacturer and your legacy test system.

 1-800-915-6216

 www.apexwaves.com

 sales@apexwaves.com

All trademarks, brands, and brand names are the property of their respective owners.

Request a Quote

 **CLICK HERE**

cRIO-9038

GETTING STARTED GUIDE

NI cRIO-9033

Embedded CompactRIO Controller with Real-Time Processor and Reconfigurable FPGA

This document describes how to begin using the National Instruments cRIO-9033.

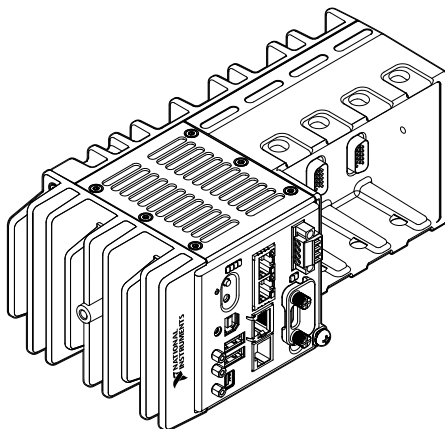

Safety Guidelines



Caution Do not operate the cRIO-9033 in a manner not specified in this document. Product misuse can result in a hazard. You can compromise the safety protection built into the product if the product is damaged in any way. If the product is damaged, return it to NI for repair.

Safety Guidelines for Hazardous Locations

The cRIO-9033 is suitable for use in Class I, Division 2, Groups A, B, C, D, T4 hazardous locations; Class I, Zone 2, AEx nA IIC T4 and Ex nA IIC T4 hazardous locations; and nonhazardous locations only. Follow these guidelines if you are installing the cRIO-9033 in a potentially explosive environment. Not following these guidelines may result in serious injury or death.



Caution Do not disconnect the power supply wires and connectors from the controller unless power has been switched off.



Caution Do not disconnect I/O-side wires or connectors unless power has been switched off or the area is known to be nonhazardous.



Caution Do not remove modules unless power has been switched off or the area is known to be nonhazardous.



Caution Substitution of components may impair suitability for Class I, Division 2.



Caution For Division 2 and Zone 2 applications, install the system in an enclosure rated to at least IP54 as defined by IEC/EN 60079-15.



Caution Do not insert or remove SD cards unless power has been switched off or the area is known to be nonhazardous.



Caution The USB host ports, USB device port, mini DisplayPort, and SD card slot require the retention accessories listed in the following table for hazardous locations. All cables must be used in a conduit or cable gland to wire to a nonhazardous location. Do not disconnect a cable unless the cRIO-9033 is powered off or the area is known to be nonhazardous.

Table 1. Hazardous Location Retention Accessories

Port	Required Accessory	Part Number
USB Host Port	NI Industrial USB Extender Cable	152166-xx
USB Device Port	NI Locking USB Cable	157788-01
Mini DisplayPort	Mini DisplayPort Cable Retention Bracket	156866-01
SD Card Slot	SD Door Kit	783660-01

Special Conditions for Hazardous Locations Use in Europe and Internationally

The cRIO-9033 has been evaluated as Ex nA IIC T4 Gc equipment under DEMKO Certificate No. 12 ATEX 1202658X and is IECEx UL 14.0089X certified. Each device is marked Ⓢ II 3G and is suitable for use in Zone 2 hazardous locations, in ambient temperatures of $-40\text{ }^{\circ}\text{C} \leq T_a \leq 70\text{ }^{\circ}\text{C}$.



Caution You must make sure that transient disturbances do not exceed 140% of the rated voltage.



Caution The system shall only be used in an area of not more than Pollution Degree 2, as defined in IEC 60664-1.



Caution The system shall be mounted in an ATEX/IECEx-certified enclosure with a minimum ingress protection rating of at least IP54 as defined in IEC/EN 60079-15.



Caution The enclosure must have a door or cover accessible only by the use of a tool.

Electromagnetic Compatibility Guidelines

This product was tested and complies with the regulatory requirements and limits for electromagnetic compatibility (EMC) stated in the product specifications. These requirements and limits provide reasonable protection against harmful interference when the product is operated in the intended operational electromagnetic environment.

This product is intended for use in industrial locations. However, harmful interference may occur in some installations, when the product is connected to a peripheral device or test object, or if the product is used in residential or commercial areas. To minimize interference with radio and television reception and prevent unacceptable performance degradation, install and use this product in strict accordance with the instructions in the product documentation.

Furthermore, any changes or modifications to the product not expressly approved by National Instruments could void your authority to operate it under your local regulatory rules.



Caution To ensure the specified EMC performance, operate this product only with shielded cables and accessories. The DC power input cables may be unshielded.



Caution To ensure the specified EMC performance, you must use an isolated cable with the RS-485 serial port, such as NI part number 184428-01.



Caution To ensure the specified EMC performance, the length of any cable connected to the video and V2 ports must be no longer than 3 m (10 ft). The length of any cable connected to the RS-232 and RS-485 ports must be no longer than 30 m (100 ft). The length of any cable connected to the USB host ports must be no longer than 5 m (16 ft).



Caution The USB device port is intended only for use in device configuration, application deployment, debug, and maintenance.



Caution To ensure the specified EMC performance, product installation requires either special considerations or user-installed, add-on devices. Refer to the following sections for more information.

Related Information

[Connecting the cRIO-9033 to Ground](#) on page 7

[Connecting the cRIO-9033 to Power](#) on page 8

Special Conditions for Marine Applications

Some products are Lloyd's Register (LR) Type Approved for marine (shipboard) applications. To verify Lloyd's Register certification for a product, visit [ni.com/certification](https://www.lloydregister.com/certification) and search for the LR certificate, or look for the Lloyd's Register mark on the product.



Caution In order to meet the EMC requirements for marine applications, install the product in a shielded enclosure with shielded and/or filtered power and input/output ports. In addition, take precautions when designing, selecting, and installing measurement probes and cables to ensure that the desired EMC performance is attained.

Preparing the Environment

Ensure that the environment in which you are using the cRIO-9033 meets the following specifications.

Operating temperature (IEC 60068-2-1, IEC 60068-2-2)	-40 °C to 70 °C
Operating humidity (IEC 60068-2-56)	10% RH to 90% RH, noncondensing
Pollution degree	2
Maximum altitude	5,000 m

Indoor use only.



Note Refer to the device specifications on [ni.com/manuals](https://www.ni.com/manuals) for complete specifications.

Unpacking the Kit



Caution To prevent electrostatic discharge (ESD) from damaging the device, ground yourself using a grounding strap or by holding a grounded object, such as your computer chassis.

1. Touch the antistatic package to a metal part of the computer chassis.
2. Remove the device from the package and inspect the device for loose components or any other sign of damage.



Caution Never touch the exposed pins of connectors.



Note Do not install a device if it appears damaged in any way.

3. Unpack any other items and documentation from the kit.

Store the device in the antistatic package when the device is not in use.

Verifying the Kit Contents

Verify that the following items are included in the cRIO-9033 kit.

Figure 1. cRIO-9033 Kit Contents

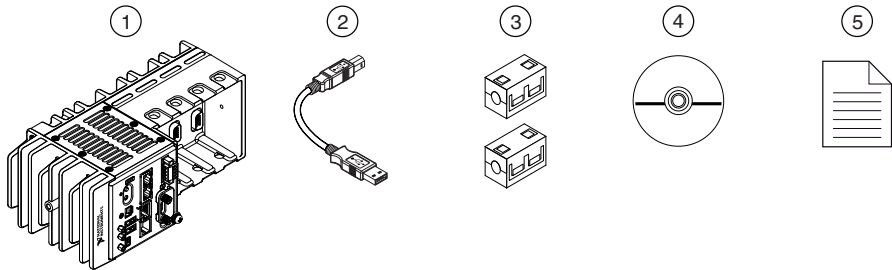

-
- | | |
|--|--------------------------------|
| 1. cRIO Device with Power Connector and SD Card Slot Cover | 4. NI-RIO Device Drivers Media |
| 2. USB A-to-B Cable | 5. Getting Started Guide |
| 3. Ferrite (x2) | |
-

Installing Software on the Host Computer

Before using the cRIO-9033, you must install the following application software and device drivers on the host computer in this order:

1. LabVIEW 2014 or later
2. LabVIEW Real-Time Module 2014 or later
3. LabVIEW FPGA Module 2014 or later¹
4. NI-RIO Device Drivers August 2014 or later

For minimum software support information, visit ni.com/info and enter the Info Code `swsupport`.

Installing C Series Modules

Complete the following steps to install a C Series module.

¹ LabVIEW FPGA Module is not required when using Scan Interface mode. To program the user-accessible FPGA on the cRIO-9033, LabVIEW FPGA Module is required.

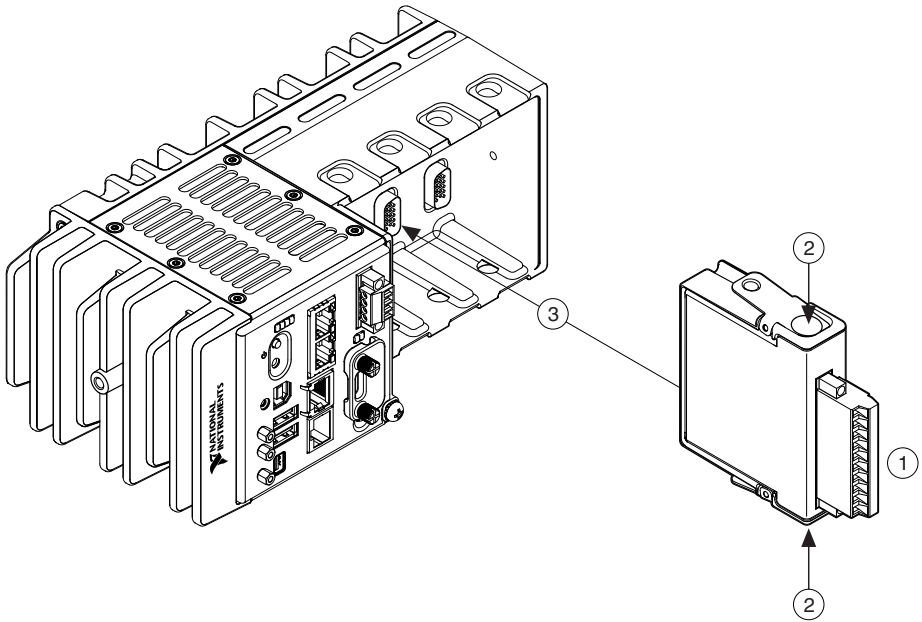

1. Verify that power is not connected to the I/O connector(s) on the C Series module. If the system is in a nonhazardous location, the cRIO-9033 can be powered on when you install modules.
2. Press the latches on the C Series module.
3. Align the C Series module with a slot and seat it in the slot until the latches lock in place.

Removing C Series Modules

Verify that power is not connected to the I/O connector(s) on the C Series module before you remove a module from the cRIO-9033. If the system is in a nonhazardous location, the cRIO-9033 can be powered on when you remove modules.

Connecting the cRIO-9033

The cRIO-9033 has the following connectors, LEDs, and buttons.

Figure 2. cRIO-9033 Front Panel

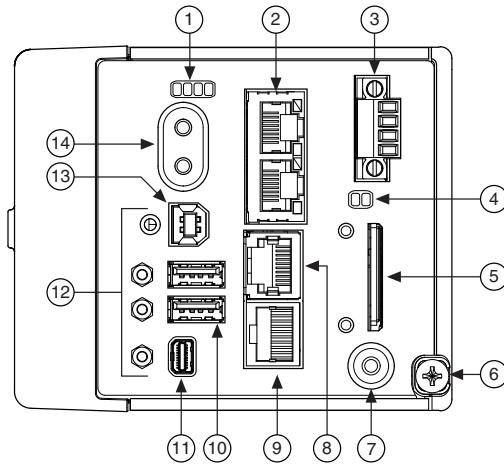

- | | |
|------------------------------|---------------------------------|
| 1. LEDs | 8. RS-232 Serial Port |
| 2. Ethernet Ports | 9. RS-485/422 (DTE) Serial Port |
| 3. Power Connector | 10. USB Host Ports |
| 4. SD LEDs | 11. Mini DisplayPort |
| 5. SD Card Removable Storage | 12. Cable Retention Mounts |
| 6. Ground Screw | 13. USB Device Port |
| 7. USER1 Button | 14. Power and Reset Buttons |

Connecting the cRIO-9033 to Ground

You must connect the cRIO-9033 grounding terminal to the grounding electrode system of the facility.

What to Use

- Ring lug
- Wire, 1.3 mm² (16 AWG) or larger
- Screwdriver, Phillips #2

What to Do

Complete the following steps to ground the cRIO-9033.

1. Attach the ring lug to the wire.
2. Remove the grounding screw from the grounding terminal on the cRIO-9033.
3. Attach the ring lug to the grounding terminal.
4. Tighten the grounding screw to 0.5 N · m (4.4 lb · in.) of torque.
5. Attach the other end of the wire to the grounding electrode system of your facility using a method that is appropriate for your application.



Caution If you use shielded cabling to connect to a C Series module with a plastic connector, you must attach the cable shield to the chassis grounding terminal using 1.3 mm² (16 AWG) or larger wire. Attach a ring lug to the wire and attach the wire to the chassis grounding terminal. Solder the other end of the wire to the cable shield. Use shorter wire for better EMC performance.

For more information about ground connections, visit ni.com/info and enter the Info Code `emcground`.

Connecting the cRIO-9033 to Power

The cRIO-9033 requires a 9 V to 30 V external power supply. The cRIO-9033 filters and regulates the supplied power and provides power for the C Series modules. The cRIO-9033 has a primary power input, V1, and a secondary power input, V2.

The POWER LED on the cRIO-9033 indicates which power input is in use, as shown in the following table.

Table 2. POWER LED Indicators

LED Color	LED Pattern	Indication
Green	Solid	The cRIO-9033 is powered from the V1 input.
Yellow	Solid	The cRIO-9033 is powered from the V2 input.
—	Off	The cRIO-9033 is powered off.



Caution Do not connect V2 to a DC mains supply or to any supply that requires a connecting cable longer than 3 m (10 ft). A DC mains supply is a local DC electricity supply network in the infrastructure of a site or building.

What to Use

- Ferrite
- Screwdriver, 2.54 mm (0.10 in.) flathead
- Primary power supply, 9 V to 30 V, 40 W minimum
- (Optional) Secondary power supply, 9 V to 30 V, 40 W minimum

NI recommends the power supplies listed in the following table for the cRIO-9033.

Table 3. NI Power Supplies

Power Supply	Part Number
NI PS-15 Industrial Power Supply (24 VDC, 5 A, 100 VAC to 120 VAC/200 VAC to 240 VAC input)	781093-01
NI PS-10 Desktop Power Supply (24 VDC, 5 A, 100 VAC to 120 VAC/200 VAC to 240 VAC input)	782698-01

What to Do

Complete the following steps to connect a power supply to the cRIO-9033.

1. Ensure that your power supply is powered off.
2. Install the ferrite on the negative and positive leads of the power supply, as shown in the following figure.

Figure 3. Installing a Ferrite on the Power Leads

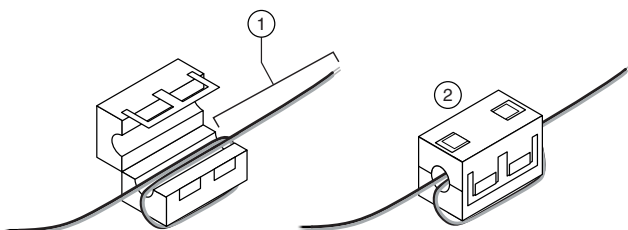

1. Pass the leads through the ferrite twice, leaving 50 mm to 75 mm (2 in. to 3 in.) between the ferrite and the end of the leads.
 2. Close the ferrite around the leads.
3. Remove the power connector from the cRIO-9033.



Caution Do not tighten or loosen the terminal screws on the power connector while the cRIO-9033 is powered on.

4. Connect the primary power supply and optional secondary power supply to the power connector, as shown in the following figure.

Figure 4. cRIO-9033 Power Connections

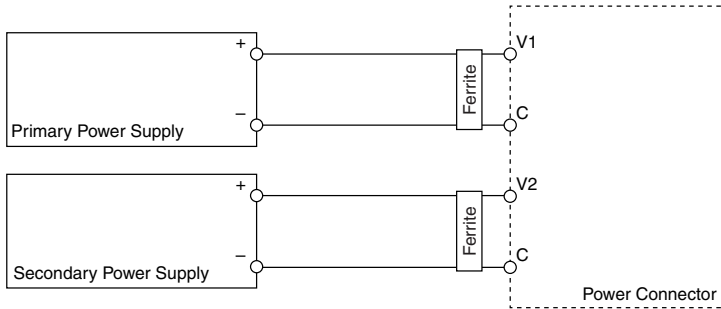

Note The C terminals are internally connected to each other.

5. Tighten the terminal screws on the power connector to 0.20 N · m to 0.25 N · m (1.8 lb · in. to 2.2 lb · in.) of torque.
6. Install the power connector on the front panel of the cRIO-9033.
7. Tighten the power connector screw flanges to 0.20 N · m to 0.25 N · m (1.8 lb · in. to 2.2 lb · in.) of torque.
8. Power on the primary power supply and optional secondary power supply.

Powering On the cRIO-9033

When you power on the cRIO-9033 for the first time, the device boots into safe mode. The POWER LED illuminates, the STATUS LED illuminates briefly, and then the STATUS LED blinks twice every few seconds.

Related Information

[STATUS LED Indicators](#) on page 14

Connecting the cRIO-9033 to the Host Computer

Complete the following steps to connect the cRIO-9033 to the host computer using the USB device port.

1. Power on the host computer.
2. Connect the cRIO-9033 to the host computer using the USB A-to-B cable.



Caution NI requires the use of a locking USB cable (157788-01) to meet the shock and vibration specifications. Refer to the specifications on ni.com/manuals for shock and vibration specifications.

The device driver software automatically detects the cRIO-9033. If the device driver software does not detect the cRIO-9033, verify that you installed the appropriate NI software in the correct order on the host computer.



Tip You can also use the Ethernet port to connect directly to the host computer or network. Refer to the user manual on ni.com/manuals for more information about Ethernet connections.

Configuring the System in Measurement & Automation Explorer (MAX)

Complete the following steps to find the system in MAX.

1. Launch MAX on the host computer.
2. Expand **Remote Systems** in the configuration tree and locate your system.
3. Select your target.



Tip MAX lists the system under the model number followed by the serial number, such as NI-CRIO-9033-1856AAA.

Setting a System Password

Complete the following steps to set a system password.



Note The default username for the cRIO-9033 is `admin`. There is no default password for the cRIO-9033, so you must leave the password field blank when logging in until you set a system password.

1. Right-click your system and select **Web Configuration**.

The NI Web-Based Configuration and Monitoring utility opens in your default browser and is where you set the password. If you have not installed Microsoft Silverlight, NI Web-based Configuration & Monitoring prompts you to do so.

2. Enter a unique name for your system in the **Hostname** field.
3. Click the **Security Configuration** icon.
4. Click **Login**.
5. In the **Login** dialog box, enter the username `admin` and leave the password field blank.
6. Click **OK**.
7. Click **Change Password**.
8. Enter and re-enter a new password.
9. Click **OK**.
10. Click **Save**.
11. Click **OK** to confirm you are changing the password.



Caution NI cannot recover lost system passwords. If you forget the password, you must contact NI and reformat the controller.

Installing Software on the cRIO-9033

Complete the following steps to install software on the cRIO-9033.

1. In MAX, expand your system under Remote Systems.
2. Right-click **Software**.
3. Select **Add/Remove Software** to launch the LabVIEW Real-Time Software Wizard.



Tip You must log in if you set a system password.

4. Select the recommended software set for your LabVIEW and NI-RIO Device Drivers versions.
5. Click **Next**.
6. Select **NI Scan Engine** from the software add-ons.

Select any additional software to install. If you plan on using the cRIO-9033 with the LabVIEW FPGA Module, you can click **Next**. Click **NI Scan Engine** if you plan on using the cRIO-9033 without the LabVIEW FPGA Module.



Tip You can use this wizard at anytime to install additional software.

7. Click **Next**.
8. Verify that the summary of software to install is correct.
9. Click **Next** to start the installation.
10. Click **Finish** when the installation is complete.

Troubleshooting the cRIO-9033

The cRIO-9033 is Not Communicating with the Network

- Ensure that the USB connections between the cRIO-9033 and the host computer and the Ethernet connections between the host computer and the router are secure.
- Configure the IP and other network settings by completing the following steps.
 1. Use a USB A-to-B cable to connect the cRIO-9033 USB device port to a host computer. The USB driver creates a virtual network interface card and assigns an IP address to the cRIO-9033 in the format of 172.22.11.x.
 2. In MAX, expand your system under Remote Systems.

3. Select the **Network Settings** tab to configure the IP and other network settings.
4. (Optional) Use the RJ-45 Ethernet port 1 to reconnect the cRIO-9033 to the host computer. The cRIO-9033 attempts to initiate a DHCP network connection at powerup.



Note If the cRIO-9033 cannot obtain an IP address, it connects to the network with a link-local IP address with the form 169.254.x.x. The host computer communicates with the cRIO-9033 over a standard Ethernet connection.

- Ensure that you have the correct version of NI-RIO Device Drivers installed on the host computer. Visit ni.com/info and enter the Info Code `swsupport` for the minimum supported versions of LabVIEW and NI-RIO Device Drivers.



Tip If you have recently upgraded LabVIEW, you must reinstall NI-RIO Device Drivers.

- Ensure that the NI USBLAN adapter is recognized in the Device Manager. On Windows 7, select **Start»Control Panel»Device Manager»Network adapters»National Instruments»USBLAN adapter**. If the USBLAN adapter is not recognized, you must reinstall NI-RIO Device Drivers.
- Temporarily disable any network firewalls or other security software.

Verify the System IP Configuration

1. Put the cRIO-9033 in safe mode and enable the RS-232 serial port by holding the RESET button down for 5 seconds.

The STATUS LED starts blinking three times every few seconds.

2. Use the RS-232 serial port terminal to read the IP address, or connect a monitor to the mini DisplayPort to view the IP address.



Note Refer to the user manual on ni.com/manuals for more information about serial port configuration.

3. Set a new DHCP connection by holding the RESET button down for 5 seconds. The STATUS LED repeats the same behavior from [Step 1](#).

If the cRIO-9033 fails to set a new DHCP address, it assigns itself a link-local IP address. If the DHCP connection is successful and appropriate for your application, skip to [Step 6](#).

4. In MAX, expand your system under Remote Systems.
5. Select the **Network Settings** tab to configure the IP and other network settings.
6. Reboot the cRIO-9033 by pressing the RESET button.

Configure the Windows Firewall

- Add an exception for MAX to your network firewall or other security software by completing the following steps:
 1. On Windows 7, select **Start»Control Panel»System and Security»Windows Firewall»Allow a program through Windows Firewall**.
 2. Click **Allow another program**.
 3. Select **Measurement & Automation**.

4. Click **Add**.
 5. Click **OK**.
- Ensure that UDP port 44525 is open to communication on the host computer. If you are using an intelligent switch on the network, ensure that it is not disabling UDP port 44525.

System Reset

The following figure shows the reset behavior of the cRIO-9033.

Figure 5. Reset Button Behavior

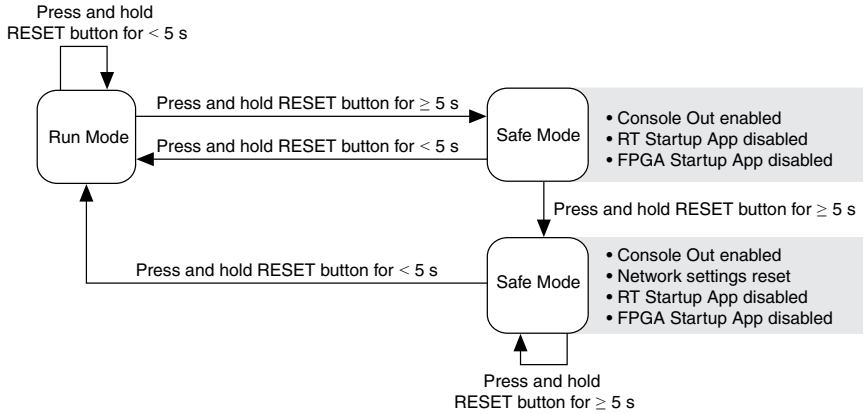

STATUS LED Indicators

The following table describes the STATUS LED indicators.

Table 4. STATUS LED Indicators

LED Color	LED Pattern	Indication
Yellow	Blinks twice and pauses	<p>The cRIO-9033 is in safe mode. Software is not installed, which is the factory default state, or software has been improperly installed on the cRIO-9033.</p> <p>An error can occur when an attempt to upgrade the software is interrupted. Reinstall software on the cRIO-9033. Refer to the <i>Measurement & Automation Explorer (MAX) Help</i> for information about installing software on the cRIO-9033.</p>
	Blinks three times and pauses	<p>The cRIO-9033 is in user-directed safe mode, or the cRIO-9033 is in install mode to indicate that software is currently being installed.</p> <p>This pattern may also indicate that the user has forced the cRIO-9033 to boot into safe mode by pressing the reset button for longer than five seconds or by enabling safe mode in MAX. Refer to the <i>Measurement & Automation Explorer (MAX) Help</i> for information about safe mode.</p>
	Blinks four times and pauses	<p>The cRIO-9033 is in safe mode. The software has crashed twice without rebooting or cycling power between crashes.</p>
	Continuously blinks	<p>The cRIO-9033 has not booted into NI Linux Real-Time. The cRIO-9033 either booted into an unsupported operating system, was interrupted during the boot process, or detected an unrecoverable software error.</p>
	On momentarily	<p>The cRIO-9033 is booting. No action required.</p>
Red	Continuously blinks	<p>This indicates a hardware error. An internal power supply has failed. Check front-panel I/O and C Series module connections for shorts. Remove any shorts and cycle power the cRIO-9033. If the problem persists, contact NI.</p>
—	Off	<p>The cRIO-9033 is in run mode. Software is installed and the operating system is running.</p>

Where to Go Next

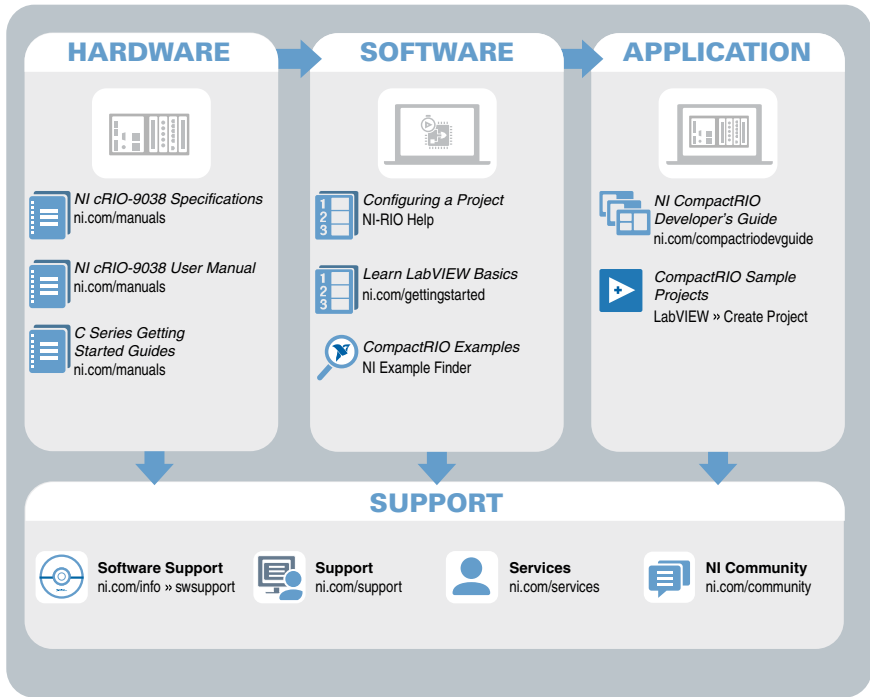

Worldwide Support and Services

The National Instruments website is your complete resource for technical support. At ni.com/support, you have access to everything from troubleshooting and application development self-help resources to email and phone assistance from NI Application Engineers.

Visit ni.com/services for NI Factory Installation Services, repairs, extended warranty, and other services.

Visit ni.com/register to register your National Instruments product. Product registration facilitates technical support and ensures that you receive important information updates from NI.

A Declaration of Conformity (DoC) is our claim of compliance with the Council of the European Communities using the manufacturer's declaration of conformity. This system affords the user protection for electromagnetic compatibility (EMC) and product safety. You can obtain the DoC for your product by visiting ni.com/certification. If your product supports calibration, you can obtain the calibration certificate for your product at ni.com/calibration.

National Instruments corporate headquarters is located at 11500 North Mopac Expressway, Austin, Texas, 78759-3504. National Instruments also has offices located around the world. For telephone support in the United States, create your service request at ni.com/support or dial 1 866 ASK MYNI (275 6964). For telephone support outside the United States, visit the *Worldwide Offices* section of ni.com/niglobal to access the branch office websites, which provide up-to-date contact information, support phone numbers, email addresses, and current events.

Refer to the *NI Trademarks and Logo Guidelines* at ni.com/trademarks for information on National Instruments trademarks. Other product and company names mentioned herein are trademarks or trade names of their respective companies. For patents covering National Instruments products/technology, refer to the appropriate location: **Help»Patents** in your software, the `patents.txt` file on your media, or the *National Instruments Patent Notice* at ni.com/patents. You can find information about end-user license agreements (EULAs) and third-party legal notices in the readme file for your NI product. Refer to the *Export Compliance Information* at ni.com/legal/export-compliance for the National Instruments global trade compliance policy and how to obtain relevant HTS codes, ECCNs, and other import/export data. NI MAKES NO EXPRESS OR IMPLIED WARRANTIES AS TO THE ACCURACY OF THE INFORMATION CONTAINED HEREIN AND SHALL NOT BE LIABLE FOR ANY ERRORS. U.S. Government Customers: The data contained in this manual was developed at private expense and is subject to the applicable limited rights and restricted data rights as set forth in FAR 52.227-14, DFAR 252.227-7014, and DFAR 252.227-7015.

© 2014—2015 National Instruments. All rights reserved.

376211B-01 Oct15