

COMPREHENSIVE SERVICES

We offer competitive repair and calibration services, as well as easily accessible documentation and free downloadable resources.

SELL YOUR SURPLUS

We buy new, used, decommissioned, and surplus parts from every NI series. We work out the best solution to suit your individual needs.

 Sell For Cash  Get Credit  Receive a Trade-In Deal

OBSOLETE NI HARDWARE IN STOCK & READY TO SHIP

We stock **New**, **New Surplus**, **Refurbished**, and **Reconditioned** NI Hardware.



Bridging the gap between the manufacturer and your legacy test system.

 1-800-915-6216

 www.apexwaves.com

 sales@apexwaves.com

All trademarks, brands, and brand names are the property of their respective owners.

Request a Quote

 **CLICK HERE**

cRIO-9039

Carrying Handle for CompactRIO & CompactDAQ

The Carrying Handle for CompactRIO & CompactDAQ kit (part number 786744-01) includes one handle that you can attach to most multi-slot NI CompactDAQ, CompactRIO, and EtherCAT chassis and controllers. For a list of compatible chassis and controllers, visit ni.com/info and enter the Info Code `carryhandle`.

Complete the following steps to install the carrying handle on your chassis or controller.

1. Align the handle with the mounting hole on one of the ends of a supported chassis or controller.
2. To provide a secure fit and limit rotational movement, use a #2 Phillips screwdriver to tighten the captive screw on the side of the handle to a torque between 2.5 N · m (22 lb · in.) and 4.0 N · m (35 lb · in.).

Figure 1. Attaching the Handle

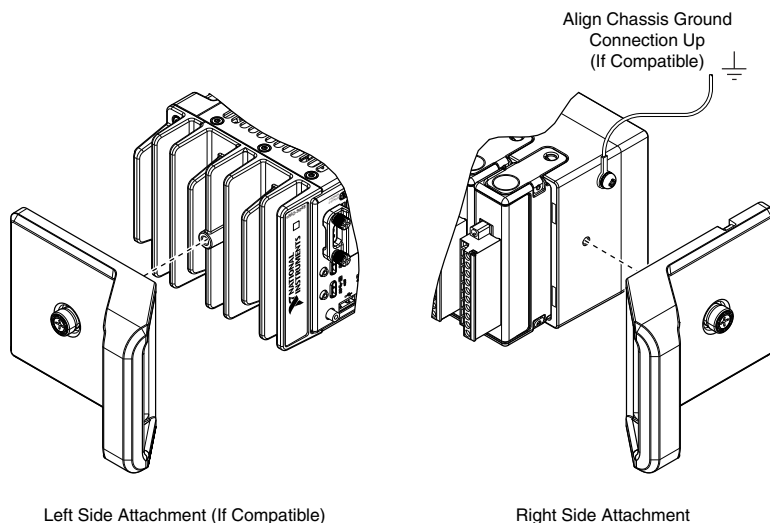

Note Some NI controller/chassis designs allow for carrying handles on either end of the product. To install handles on both ends of a chassis or controller, you must purchase two kits.

Figure 2. Carrying Handle Dimensions

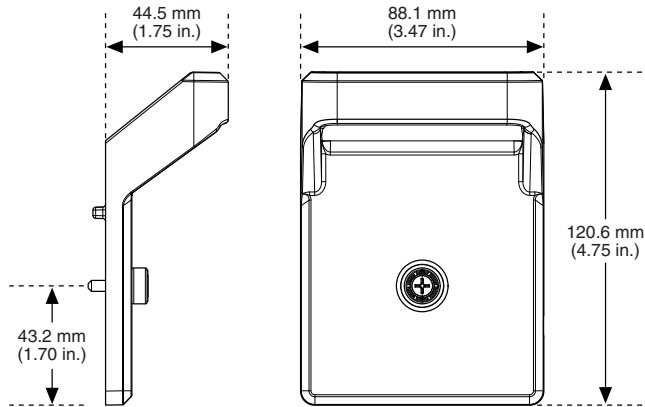

Information is subject to change without notice. Refer to the *NI Trademarks and Logo Guidelines* at ni.com/trademarks for information on NI trademarks. Other product and company names mentioned herein are trademarks or trade names of their respective companies. For patents covering NI products/technology, refer to the appropriate location: **Help>Patents** in your software, the `patents.txt` file on your media, or the *National Instruments Patent Notice* at ni.com/patents. You can find information about end-user license agreements (EULAs) and third-party legal notices in the `readme` file for your NI product. Refer to the *Export Compliance Information* at ni.com/legal/export-compliance for the NI global trade compliance policy and how to obtain relevant HTS codes, ECCNs, and other import/export data. NI MAKES NO EXPRESS OR IMPLIED WARRANTIES AS TO THE ACCURACY OF THE INFORMATION CONTAINED HEREIN AND SHALL NOT BE LIABLE FOR ANY ERRORS. U.S. Government Customers: The data contained in this manual was developed at private expense and is subject to the applicable limited rights and restricted data rights as set forth in FAR 52.227-14, DFAR 252.227-7014, and DFAR 252.227-7015.

© 2018 National Instruments. All rights reserved.

377539A-01 April 17, 2018