

COMPREHENSIVE SERVICES

We offer competitive repair and calibration services, as well as easily accessible documentation and free downloadable resources.

SELL YOUR SURPLUS

We buy new, used, decommissioned, and surplus parts from every NI series. We work out the best solution to suit your individual needs.

 Sell For Cash  Get Credit  Receive a Trade-In Deal

OBSOLETE NI HARDWARE IN STOCK & READY TO SHIP

We stock **New**, **New Surplus**, **Refurbished**, and **Reconditioned** NI Hardware.



Bridging the gap between the manufacturer and your legacy test system.

 1-800-915-6216

 www.apexwaves.com

 sales@apexwaves.com

All trademarks, brands, and brand names are the property of their respective owners.

Request a Quote

 **CLICK HERE**

cRIO-9067

Module Immobilization Accessory

This document provides installation instructions for the NI Module Immobilization Accessory.

Table 1. NI Module Immobilization Accessory Compatibility

CompactDAQ Chassis	CompactRIO Chassis		CompactRIO with DAQmx Chassis		Ethernet and EtherCAT Expansion Chassis
cDAQ-9132	cRIO-9030	cRIO-9063	cRIO-9040	cRIO-9053	NI 9145
cDAQ-9133	cRIO-9031	cRIO-9064	cRIO-9041	cRIO-9054	NI 9146
cDAQ-9134	cRIO-9032	cRIO-9065	cRIO-9042	cRIO-9055	NI 9147
cDAQ-9135	cRIO-9033	cRIO-9066	cRIO-9043	cRIO-9056	NI 9149
cDAQ-9136	cRIO-9034	cRIO-9067	cRIO-9045	cRIO-9057	
cDAQ-9137	cRIO-9035		cRIO-9046	cRIO-9058	
cDAQ-9184	cRIO-9036		cRIO-9047		
cDAQ-9185	cRIO-9037		cRIO-9048		
cDAQ-9189	cRIO-9038		cRIO-9049		
	cRIO-9039				

Installing the Module Immobilization Accessory

The Module Immobilization accessory ensures that the C Series module latches cannot be retracted and modules cannot be removed from a system. The Module Immobilization accessory provides extra system assurance and security when shipping and installing systems, and prevents accidental removal from a system during operation.



Note When using the Module Immobilization accessory, NI recommends installing the accessory prior to mounting the system in any enclosure because the accessory requires tool access to the top, right, and bottom of the chassis.

Installing the Module Immobilization Accessory Variant 1 (Part Number 158533-01 or 158534-01)

Table 2. Accessory Variant 1 Compatibility

Kit Part Number	Model Number
158533-01	cDAQ-9133, cDAQ-9135, cDAQ-9137
	cRIO-9035, cRIO-9036, cRIO-9037, cRIO-9038, cRIO-9039
	cRIO-9045, cRIO-9046, cRIO-9047, cRIO-9048, cRIO-9049
158534-01	cDAQ-9132, cDAQ-9134, cDAQ-9136
	cRIO-9030, cRIO-9031, cRIO-9032, cRIO-9033, cRIO-9034
	cRIO-9040, cRIO-9041, cRIO-9042, cRIO-9043

What to Use

- CompactRIO or CompactDAQ Chassis
- C Series modules
- Module Immobilization accessory kit, 158533-01 (8-slot) or 158534-01 (4-slot)
 - Module immobilization bracket
 - Installation screws¹
 - M4 x 0.7 button-head screw, 8 mm
 - M3 x 0.5 flat-head screws (x2), 10 mm
- Torx T10/T10H driver
- Torx T20/T20H driver

¹ The Module Immobilization accessory kit includes two sets of screws. One set is a standard set of screws that require a standard driver type, Torx T10 and T20. The other set is a tamper-resistant set of screws that require a security driver type, Torx T10H and T20H. Use the tamper-resistant set to help prevent unintended modification of the system.

Figure 1. Installing the Module Immobilization Accessory

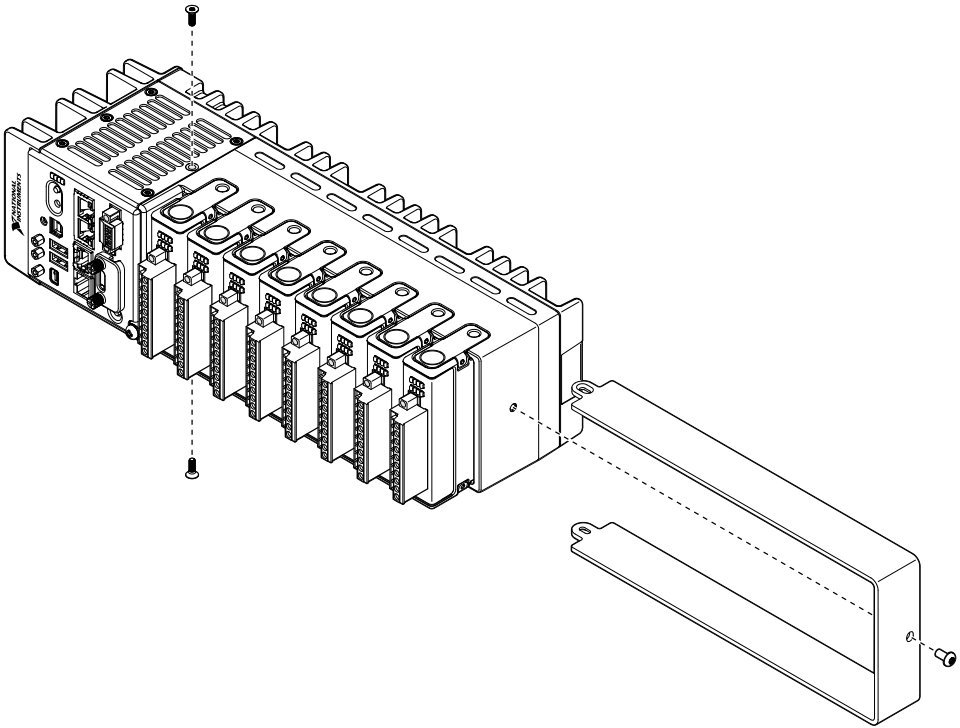

Tip NI recommends using a liquid thread locker for all fasteners if the system is expected to experience vibration for an extended amount or time.



Tip Thread all screws into place before tightening to maximum torque.

1. Ensure that all the C Series modules are installed in the chassis and the latches are locked in place.
2. Remove the center right panel screw from the top and bottom of the chassis using the Torx T10 driver.
3. Slide the bracket into place, aligning the three clearance screw holes.
4. Thread the M4 x 0.7 button-head screw into the right end of the chassis using the appropriate Torx T20 driver, but do not fully tighten the screw.
5. Thread the two M3 x 0.5 flat-head screws from the accessory kit into the top and bottom of the chassis using the appropriate Torx T10 driver, but do not fully tighten the screws.
6. Tighten all screws to a maximum torque of 1.3 N · m (11.5 lb · in.) using the appropriate Torx driver.

Installing the Module Immobilization Accessory Variant 2 (Part Number 158533-02 or 158534-02)

Table 3. Accessory Variant 2 Compatibility

Kit Part Number	Model Number	Bracket Adapter Orientation
158533-02	cRIO-9056, cRIO-9057, cRIO-9058	Low Hole
	cRIO-9066, cRIO-9067	High Hole
	NI-9145, NI-9149	
	cDAQ-9189	
158534-02	cRIO-9053, cRIO-9054, cRIO-9055	Low Hole
	cRIO-9063, cRIO-9064, cRIO-9065	High Hole
	NI-9146, NI-9147	
	cDAQ-9184, cDAQ-9185	

What to Use

- CompactRIO, CompactDAQ, or Expansion Chassis
- C Series modules
- Module Immobilization accessory kit, 158533-02 (8-slot) or 158534-02 (4-slot)
 - Module immobilization bracket
 - Module immobilization bracket adapter
 - Installation screws²
 - M4 x 0.7 button-head screw, 8 mm
 - M3 x 0.5 flat-head screws (x2), 10 mm
- Torx T10/T10H driver
- Torx T20/T20H driver

² The Module Immobilization accessory kit includes two sets of screws. One set is a standard set of screws that require a standard driver type, Torx T10 and T20. The other set is a tamper-resistant set of screws that require a security driver type, Torx T10H and T20H. Use the tamper-resistant set to help prevent unintended modification of the system.

Figure 2. Installing the Module Immobilization Accessory

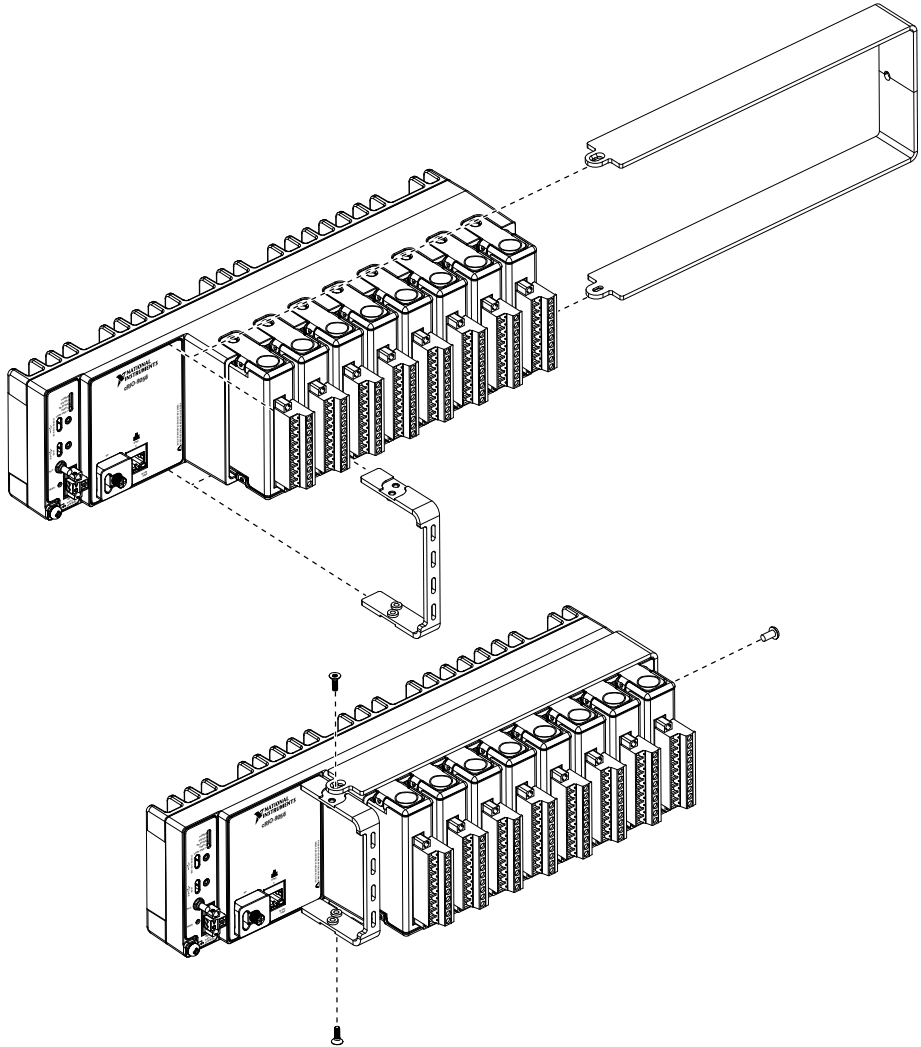

Figure 3. Low Hole Orientation

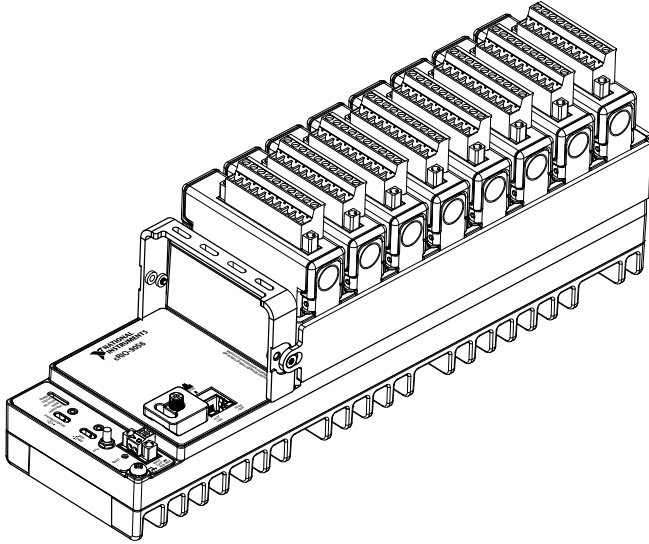
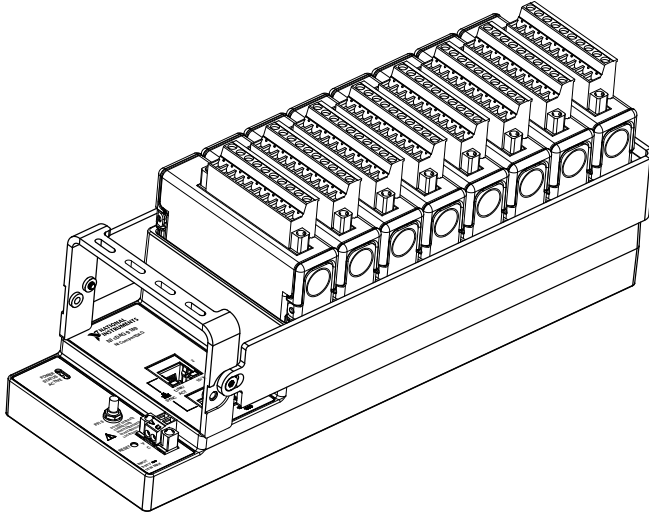

Figure 4. High Hole Orientation



Tip NI recommends using a liquid thread locker for all fasteners if the system is expected to experience vibration for an extended amount or time.



Tip Thread all screws into place before tightening to maximum torque.

1. Ensure that all the C Series modules are installed in the chassis and the latches are locked in place.
2. Slide the bracket into place, aligning the rear clearance screw hole.
3. Thread the M4 x 0.7 button-head screw into the right end of the chassis using the appropriate Torx T20 driver, but do not fully tighten the screw.
4. Align the adapter bracket with the open end of the immobilization bracket, ensuring that the bottom legs of the adapter bracket are flush with the top face of the chassis.
5. Thread the two M3 x 0.5 flat-head screws from the accessory kit into the top and bottom of the adapter bracket using the appropriate Torx T10 driver, but do not fully tighten the screw.
6. Tighten all screws to a maximum torque of $1.3 \text{ N} \cdot \text{m}$ ($11.5 \text{ lb} \cdot \text{in.}$) using the appropriate Torx driver.

Information is subject to change without notice. Refer to the *NI Trademarks and Logo Guidelines* at ni.com/trademarks for information on NI trademarks. Other product and company names mentioned herein are trademarks or trade names of their respective companies. For patents covering NI products/technology, refer to the appropriate location: **Help»Patents** in your software, the `patents.txt` file on your media, or the *National Instruments Patent Notice* at ni.com/patents. You can find information about end-user license agreements (EULAs) and third-party legal notices in the `readme` file for your NI product. Refer to the *Export Compliance Information* at ni.com/legal/export-compliance for the NI global trade compliance policy and how to obtain relevant HTS codes, ECCNs, and other import/export data. NI MAKES NO EXPRESS OR IMPLIED WARRANTIES AS TO THE ACCURACY OF THE INFORMATION CONTAINED HEREIN AND SHALL NOT BE LIABLE FOR ANY ERRORS. U.S. Government Customers: The data contained in this manual was developed at private expense and is subject to the applicable limited rights and restricted data rights as set forth in FAR 52.227-14, DFAR 252.227-7014, and DFAR 252.227-7015.

© 2015—2019 National Instruments. All rights reserved.

375308B-01 July 23, 2019