



National Instruments PCI-Step-4CX Manual
Get Pricing & Availability at
ApexWaves.com

Call Today: 1-800-915-6216
Email: sales@apexwaves.com

<https://www.apexwaves.com/modular-systems/national-instruments/pci-controllers/PCI-Step-4CX>

Motion Control

ValueMotion™ Hardware User Manual

Internet Support

E-mail: support@natinst.com

FTP Site: <ftp.natinst.com>

Web Address: <http://www.natinst.com>

Bulletin Board Support

BBS United States: 512 794 5422

BBS United Kingdom: 01635 551422

BBS France: 01 48 65 15 59

Fax-on-Demand Support

512 418 1111

Telephone Support (USA)

Tel: 512 795 8248

Fax: 512 794 5678

International Offices

Australia 03 9879 5166, Austria 0662 45 79 90 0, Belgium 02 757 00 20, Brazil 011 288 3336,
Canada (Ontario) 905 785 0085, Canada (Québec) 514 694 8521, Denmark 45 76 26 00, Finland 09 725 725 11,
France 01 48 14 24 24, Germany 089 741 31 30, Hong Kong 2645 3186, Israel 03 6120092, Italy 02 413091,
Japan 03 5472 2970, Korea 02 596 7456, Mexico 5 520 2635, Netherlands 0348 433466, Norway 32 84 84 00,
Singapore 2265886, Spain 91 640 0085, Sweden 08 730 49 70, Switzerland 056 200 51 51, Taiwan 02 377 1200,
United Kingdom 01635 523545

National Instruments Corporate Headquarters

6504 Bridge Point Parkway Austin, Texas 78730-5039 USA Tel: 512 794 0100

Important Information

Warranty

The ValueMotion servo and stepper motion control boards are warranted against defects in materials and workmanship for a period of one year from the date of shipment, as evidenced by receipts or other documentation. National Instruments will, at its option, repair or replace equipment that proves to be defective during the warranty period. This warranty includes parts and labor.

The media on which you receive National Instruments software are warranted not to fail to execute programming instructions, due to defects in materials and workmanship, for a period of 90 days from date of shipment, as evidenced by receipts or other documentation. National Instruments will, at its option, repair or replace software media that do not execute programming instructions if National Instruments receives notice of such defects during the warranty period. National Instruments does not warrant that the operation of the software shall be uninterrupted or error free.

A Return Material Authorization (RMA) number must be obtained from the factory and clearly marked on the outside of the package before any equipment will be accepted for warranty work. National Instruments will pay the shipping costs of returning to the owner parts which are covered by warranty.

National Instruments believes that the information in this manual is accurate. The document has been carefully reviewed for technical accuracy. In the event that technical or typographical errors exist, National Instruments reserves the right to make changes to subsequent editions of this document without prior notice to holders of this edition. The reader should consult National Instruments if errors are suspected. In no event shall National Instruments be liable for any damages arising out of or related to this document or the information contained in it.

EXCEPT AS SPECIFIED HEREIN, NATIONAL INSTRUMENTS MAKES NO WARRANTIES, EXPRESS OR IMPLIED, AND SPECIFICALLY DISCLAIMS ANY WARRANTY OF MERCHANTABILITY OR FITNESS FOR A PARTICULAR PURPOSE. CUSTOMER'S RIGHT TO RECOVER DAMAGES CAUSED BY FAULT OR NEGLIGENCE ON THE PART OF NATIONAL INSTRUMENTS SHALL BE LIMITED TO THE AMOUNT THERETOFORE PAID BY THE CUSTOMER. NATIONAL INSTRUMENTS WILL NOT BE LIABLE FOR DAMAGES RESULTING FROM LOSS OF DATA, PROFITS, USE OF PRODUCTS, OR INCIDENTAL OR CONSEQUENTIAL DAMAGES, EVEN IF ADVISED OF THE POSSIBILITY THEREOF. This limitation of the liability of National Instruments will apply regardless of the form of action, whether in contract or tort, including negligence. Any action against National Instruments must be brought within one year after the cause of action accrues. National Instruments shall not be liable for any delay in performance due to causes beyond its reasonable control. The warranty provided herein does not cover damages, defects, malfunctions, or service failures caused by owner's failure to follow the National Instruments installation, operation, or maintenance instructions; owner's modification of the product; owner's abuse, misuse, or negligent acts; and power failure or surges, fire, flood, accident, actions of third parties, or other events outside reasonable control.

Copyright

Under the copyright laws, this publication may not be reproduced or transmitted in any form, electronic or mechanical, including photocopying, recording, storing in an information retrieval system, or translating, in whole or in part, without the prior written consent of National Instruments Corporation.

Trademarks

BridgeVIEW™, CVI™, LabVIEW™, nuDrive™, and ValueMotion™ are trademarks of National Instruments Corporation. Product and company names listed are trademarks or trade names of their respective companies.

WARNING REGARDING MEDICAL AND CLINICAL USE OF NATIONAL INSTRUMENTS PRODUCTS

National Instruments products are not designed with components and testing intended to ensure a level of reliability suitable for use in treatment and diagnosis of humans. Applications of National Instruments products involving medical or clinical treatment can create a potential for accidental injury caused by product failure, or by errors on the part of the user or application designer. Any use or application of National Instruments products for or involving medical or clinical treatment must be performed by properly trained and qualified medical personnel, and all traditional medical safeguards, equipment, and procedures that are appropriate in the particular situation to prevent serious injury or death should always continue to be used when National Instruments products are being used. National Instruments products are NOT intended to be a substitute for any form of established process, procedure, or equipment used to monitor or safeguard human health and safety in medical or clinical treatment.

Contents

About This Manual

Organization of This Manual	ix
Conventions Used in This Manual	x
Related Documentation	xi
Customer Communication	xi

Chapter 1

Introduction

About the ValueMotion Boards	1-1
What You Need to Get Started	1-1
Software Programming Choices	1-2
National Instruments Application Software	1-3
Optional Equipment	1-3
Motion Signal and Motion I/O Connections	1-4

Chapter 2

Configuration and Installation

Software Installation	2-1
Board Configuration	2-1
Hardware Installation	2-2

Chapter 3

Hardware Overview

Functional Modes	3-4
Trapezoidal Profile Position Control	3-4
Velocity Control	3-5
Velocity Profiling	3-5
Event-Based Motion Profiling	3-5
Electronic Gearing (Servo Only)	3-6
Trajectory Parameters	3-6
Position Value Loading	3-6
Velocity Value Loading	3-7
Acceleration Value Loading	3-7
Address Table	3-8

Chapter 4 Signal Connections

I/O Connector	4-1
External Connector Wiring Recommendations	4-5
Bus Power Signal.....	4-6
I/O Port and Inhibit Signals	4-6
Input Signals	4-6
Output Signals	4-7
Wiring Concerns.....	4-7
Jumper Configuration	4-7
I/O Port Hardware Circuit	4-8
Limit and Home Switches.....	4-9
Wiring Concerns.....	4-9
Limit and Home Switch Input Circuit	4-9
Encoder Connections (Closed-Loop Boards Only)	4-10
Wiring Concerns.....	4-11
Encoder Signals	4-11
Encoder Index Pulse Signal.....	4-11
Encoder Signal Input Circuit	4-12
Auxiliary 24-Bit Digital I/O Connector (Stepper Only).....	4-12
ADC Inputs.....	4-16
ADC Overview	4-17

Appendix A Specifications

Appendix B Cable Connector Descriptions

Appendix C Customer Communication

Glossary

Index

Figures

Figure 3-1.	PC-Servo Parts Locator Diagram	3-1
Figure 3-2.	PC-Step Parts Locator Diagram	3-2
Figure 3-3.	PCI-Servo Parts Locator Diagram.....	3-2
Figure 3-4.	PCI-Step Parts Locator Diagram.....	3-3
Figure 3-5.	PXI-Step Parts Locator Diagram.....	3-4
Figure 4-1.	50-Pin Servo Connector Pin Assignment	4-2
Figure 4-2.	50-Pin Stepper Connector Pin Assignment	4-3
Figure 4-3.	68-Pin PXI Stepper Pin Assignment	4-4
Figure 4-4.	I/O Port Input and Output Hardware Circuitry	4-8
Figure 4-5.	Limit Switch and Home Switch Input Hardware Circuitry.....	4-10
Figure 4-6.	Quadrature Encoder Phasing Diagram	4-10
Figure 4-7.	Encoder Feedback Input Hardware Circuitry.....	4-12
Figure 4-8.	Auxiliary 24-bit Digital I/O 50-Pin Connector	4-13
Figure 4-9.	Auxiliary 24-Bit Digital I/O Port Configuration.....	4-14
Figure 4-10.	PC-Step Port C Direction Setting.....	4-15
Figure 4-11.	PCI- and PXI-Step Port C Direction Setting.....	4-16
Figure 4-12.	External Pinout Assignment for the 10-Pin ADC Connector.....	4-16
Figure B-1.	50-Pin Servo Connector Pin Assignment	B-1
Figure B-2.	50-Pin Stepper Connector Pin Assignment	B-2

Tables

Table 3-1.	ISA Bus Address Map	3-9
Table 4-1.	Signal Descriptions for I/O Connector Pins	4-5
Table 4-2.	Jumper Pin I/O Port Bit Correspondence	4-7

About This Manual

This manual describes the electrical and mechanical aspects of each board in the ValueMotion family of motion control boards and contains information concerning their operation and programming. Unless otherwise noted, text applies to all boards in the ValueMotion family.

The ValueMotion family of motion control boards includes:

- ◆ Servo
 - PC-Servo-4A, PC-Servo-2A
 - PCI-Servo-4A, PCI-Servo-2A
- ◆ Stepper (Open-Loop)
 - PC-Step-4OX, PC-Step-2OX
 - PCI-Step-4OX, PCI-Step-2OX
 - PXI-7314
- ◆ Stepper (Closed-Loop)
 - PC-Step-4CX, PC-Step-2CX
 - PCI-Step-4CX, PCI-Step-2CX
 - PXI-7324

The ValueMotion servo and stepper boards are low-cost, high-performance motion control boards for ISA, PCI, and PXI bus computers.

Organization of This Manual

The *ValueMotion Hardware User Manual* is organized as follows:

- Chapter 1, *Introduction*, describes the ValueMotion boards and provides information concerning their operation.
- Chapter 2, *Configuration and Installation*, describes how to configure and install your ValueMotion board.
- Chapter 3, *Hardware Overview*, presents an overview of the hardware functionality on the ValueMotion board.
- Chapter 4, *Signal Connections*, describes how to make input and output signal connections to the ValueMotion boards.

- Appendix A, *Specifications*, lists the specifications of the ValueMotion boards.
- Appendix B, *Cable Connector Descriptions*, describes the connectors on the optional cables for your ValueMotion boards.
- Appendix C, *Customer Communication*, contains forms you can use to request help from National Instruments or to comment on our products and documentation.
- The *Glossary* contains an alphabetical list and description of terms used in this manual, including abbreviations, acronyms, metric prefixes, mnemonics, and symbols.
- The *Index* contains an alphabetical list of key terms and topics in this manual, including the page where you can find each one.

Conventions Used in This Manual

The following conventions are used in this manual:



Angle brackets containing numbers separated by an ellipsis represent a range of values associated with a bit, signal, or port (for example, ACH<0..7> stands for ACH0 through ACH7).



The ♦ symbol indicates that the text following it applies only to a specific product, a specific operating system, or a specific software version.



This icon to the left of bold italicized text denotes a note, which alerts you to important information.



This icon to the left of bold italicized text denotes a caution, which advises you of precautions to take to avoid injury, data loss, or a system crash.

bold

Bold text denotes the names of menus, menu items, parameters, dialog boxes, dialog box buttons or options, icons, and windows.

bold italic

Bold italic text denotes a note, caution, or warning.

Closed-Loop Stepper

Refers to the PC-Step-2CX, PC-Step-4CX, PCI-Step-2CX, PCI-Step-4CX, and the PXI-7324.

italic

Italic text denotes variables, emphasis, a cross reference, or an introduction to a key concept. This font also denotes text from which you supply the appropriate word or value, as in Windows 95.

Open-Loop Stepper	Refers to the PC-Step-2OX, PC-Step-4OX, PCI-Step-2OX, PCI-Step-4OX, and the PXI-7314.
Servo	Refers to the PC-Servo-2A, PC-Servo-4A, PCI-Servo-2A, and PCI-Servo-4A.
Stepper	Refers to the PC-Step-2OX, PC-Step-4OX, PC-Step-2CX, PC-Step-4CX, PCI-Step-2OX, PCI-Step-4OX, PCI-Step-2CX, PCI-Step-4CX, PXI-7314, and PXI-7324.

Related Documentation

The following documents contain information you may find helpful as you read this manual:

- *ValueMotion Software Reference Manual*
- *PCI Local Bus Specification, Revision 2.1*
- *ValueMotion VI Online Help*
- Your computer's technical reference manual

Customer Communication

National Instruments wants to receive your comments on our products and manuals. We are interested in the applications you develop with our products, and we want to help if you have problems with them. To make it easy for you to contact us, this manual contains comment and configuration forms for you to complete. These forms are in Appendix C, *Customer Communication*, at the end of this manual.

Introduction

This chapter describes the ValueMotion boards and provides information concerning their operation.

About the ValueMotion Boards

The ValueMotion servo and stepper boards are servo/stepper motor controllers for ISA, PCI, and PXI bus computers. These boards provide fully programmable motion control for up to four independent axes of motors, with additional I/O for limit and home switches as well as other general-purpose functions. You can use these boards in position or velocity control applications, with support for point-to-point position, velocity profiling, and event-based motion profiling modes.

With the servo boards you can control servo motors and always operate in closed-loop mode. These boards use quadrature encoders for position and velocity feedback and ± 10 V analog outputs for command. Closed-loop stepper boards control stepper motors and can operate in open or closed-loop mode. They use quadrature encoders for position and velocity feedback, and step/direction or clockwise (CW)/counter-clockwise (CCW) digital outputs for command. Open-loop stepper boards do not include the quadrature encoders and can operate only in open-loop mode. All stepper boards support full-, half-, and microstepping applications.

What You Need to Get Started

To set up and use your ValueMotion board, you will need the following:

- One of the ValueMotion boards:
 - ◆ Servo
 - PC-Servo-4A, PC-Servo-2A
 - PCI-Servo-4A, PCI-Servo-2A

- ◆ Stepper (Open-Loop)
 - PC-Step-4OX, PC-Step-2OX
 - PCI-Step-4OX, PCI-Step-2OX
 - PXI-7314
- ◆ Stepper (Closed-Loop)
 - PC-Step-4CX, PC-Step-2CX
 - PCI-Step-4CX, PCI-Step-2CX
 - PXI-7324
- ValueMotion Hardware User Manual*
- One of the following software packages and documentation:
 - BridgeVIEW
 - LabVIEW
 - LabWindows/CVI
 - ValueMotion Software (includes pcRunner)
- Your computer with an available ISA, PCI, or PXI slot, as appropriate

Software Programming Choices

You have several options to choose from when programming your National Instruments ValueMotion boards. You can use National Instruments application software, ValueMotion Software, or register-level programming.

Programming the servo and stepper ValueMotion controller boards is straightforward using a simple but powerful high-level function set application programming environment (API). All set up and motion control functions are easily executed through register-level communications or may be implemented using driver level functions, callable from assembly language, C, or other high-level languages. Full function set implementations are available for LabVIEW, LabWindows/CVI, BridgeVIEW, Visual Basic, and other industry standard software programs.

National Instruments Application Software

LabVIEW and BridgeVIEW, based on the graphical programming language G, feature interactive graphics and a state-of-the-art user interface. In LabVIEW and BridgeVIEW, you can create 32-bit compiled programs and stand-alone executables for custom data acquisition, test, and measurement solutions. National Instruments offers the ValueMotion VI Library, a series of virtual instruments (VIs) for using LabVIEW or BridgeVIEW with National Instruments motion control hardware. This VI library implements the full function set API and a powerful set of demo functions, example programs, and fully operational, high-level application routines.

ANSI C-based LabWindows/CVI also features interactive graphics and a state-of-the-art user interface. Using LabWindows/CVI, you can generate C code for custom data acquisition, test, and measurement solutions. The ValueMotion Software Kit includes a series of functions for using LabWindows/CVI with National Instruments motion control hardware.

Optional Equipment

National Instruments offers a variety of products to use with ValueMotion boards, including cables, connector blocks, Universal Motion Interfaces (UMIs) driver amplifier units, and other accessories, as follows:

- Cables and cable assemblies
- Connector blocks, shielded and unshielded 50- and 68-pin screw terminals
- UMI connectivity blocks with integrated motion signal conditioning and motion inhibit functionality
- nuDrive, stepper, and servo motor compatible driver amplifier units with integrated power supply and wiring connectivity

For more specific information about these products, refer to your National Instruments catalogue, the motion control product brochure, or call the office nearest you.

Motion Signal and Motion I/O Connections

The external connector on the PXI motion control boards is a 68-pin male SCSI-II type connector. The other motion control boards use a 50-pin male, right-angle, box-header connector.

The auxiliary 24-bit digital I/O port connector on the stepper boards is a 50-pin male, box-header connector.

The analog to digital converter (ADC) connector on the stepper boards is a 10-pin male, box-header connector.

You can use any compatible female mating connector. Mating connector types include insulation displacement ribbon cable connectors and discrete wire female mating connectors.

Configuration and Installation

This chapter describes how to configure and install your ValueMotion board.

Software Installation

Install your ValueMotion driver and pcRunner software, along with the VI libraries (if appropriate) before you install the ValueMotion board. Refer to the appropriate release notes and your software documentation for specific instructions on the software installation sequence.

Board Configuration

There are two types of configuration to be performed on the motion control boards: bus-related and motion I/O-related configuration.

The motion I/O related configuration includes such settings as limit switch polarity, I/O port direction, motion mechanical system variables, and others. Most of these settings are software configurable, while some require hardware jumpers to be configured properly. Refer to Chapter 4, *Signal Connections*, for motion I/O related hardware jumper settings.

- ◆ PC boards

The PC boards may occupy any available 16-bit ISA slot in the host computer. The bus communication address of the boards is set with a DIP switch. See Chapter 3, *Hardware Overview*, for more information on setting the base address DIP switch. You can install multiple PC-Servo or PC-Step boards with different addresses in the host computer

**Note**

Interrupt Request (IRQ) jumpers are provided for future expansion and are not presently used on the PC-Servo or PC-Step boards. Leave all six jumper locations empty.

- ◆ PCI and PXI boards

The PCI and PXI boards are fully compatible with the *PCI Local Bus Specification, Revision 2.1*. This compatibility allows the computer to automatically perform all bus-related configuration and requires no user interaction. There are no jumpers to configure for bus-related configuration.

Hardware Installation

You can install the ValueMotion board in any open compatible ISA, PCI, or PXI expansion slot in your computer. The following are general installation instructions, but consult your computer user manual or technical reference manual for specific instructions and warnings.

- ◆ PC and PCI boards

1. Write down the ValueMotion board serial number in the [ValueMotion Hardware and Software Configuration Form](#) in Appendix C, *Customer Communication*, of this manual.
2. Turn off and unplug your computer.
3. Remove the top cover or access port to the I/O channel.
4. Remove the expansion slot cover on the back panel of the computer.
5. Insert the ValueMotion board into a 5 V ISA or PCI slot as appropriate. Gently rock the board to ease it into place. It may be a tight fit, but *do not force* the board into place.
6. If required, screw the mounting bracket of the ValueMotion board to the back panel rail of the computer.
7. Replace the cover.
8. Plug in and turn on your computer.

Your PC/PCI ValueMotion board is installed.

- ◆ PXI boards
 1. Write down the ValueMotion board serial number in the [ValueMotion Hardware and Software Configuration Form](#) in Appendix C, *Customer Communication*, of this manual.
 2. Turn off and unplug your chassis.
 3. Choose an unused 5 V peripheral slot.
 4. Remove the filler panel for the peripheral slot you have chosen.
 5. Touch a metal part on your chassis to discharge any static electricity that might be on your clothes or body.
 6. Insert the PXI board into the slot. Use the injector/ejector handle to fully inject the device into place.
 7. Screw the front panel of the PXI board to the front panel mounting rails of the chassis.
 8. Visually verify the installation.
 9. Plug in and turn on the chassis.

Your PXI ValueMotion board is installed.

Hardware Overview

This chapter presents an overview of the hardware functionality on the ValueMotion board.

Figures 3-1 through 3-5 show the PC, PCI, and PXI parts locator diagrams.

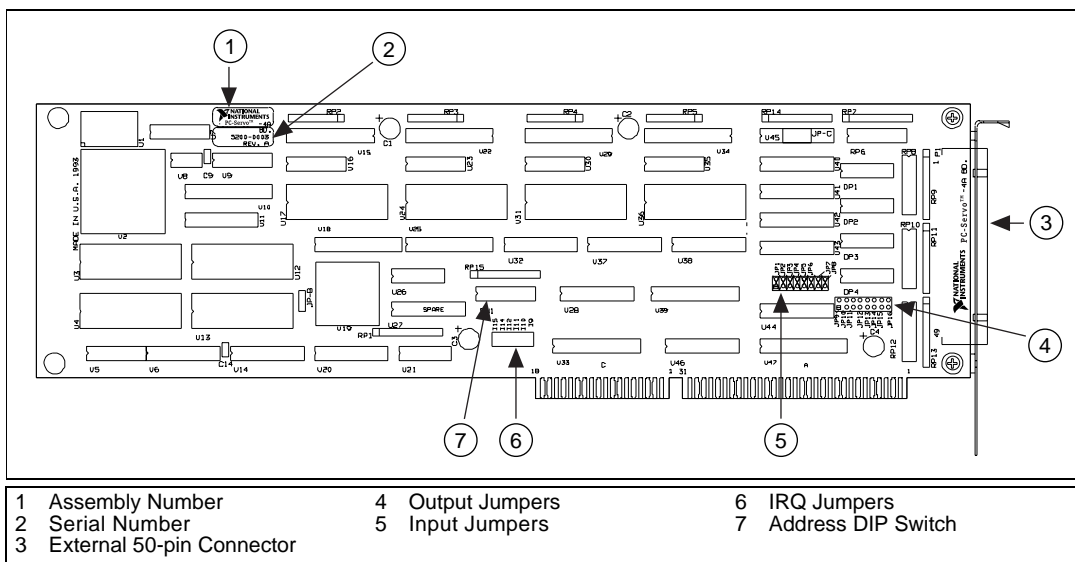

Figure 3-1. PC-Servo Parts Locator Diagram

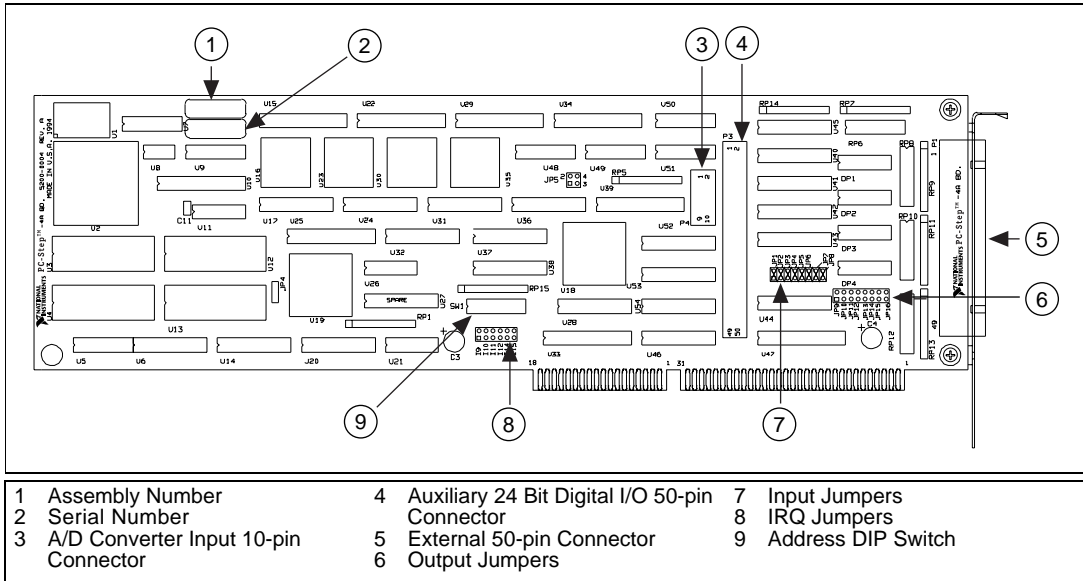

Figure 3-2. PC-Step Parts Locator Diagram

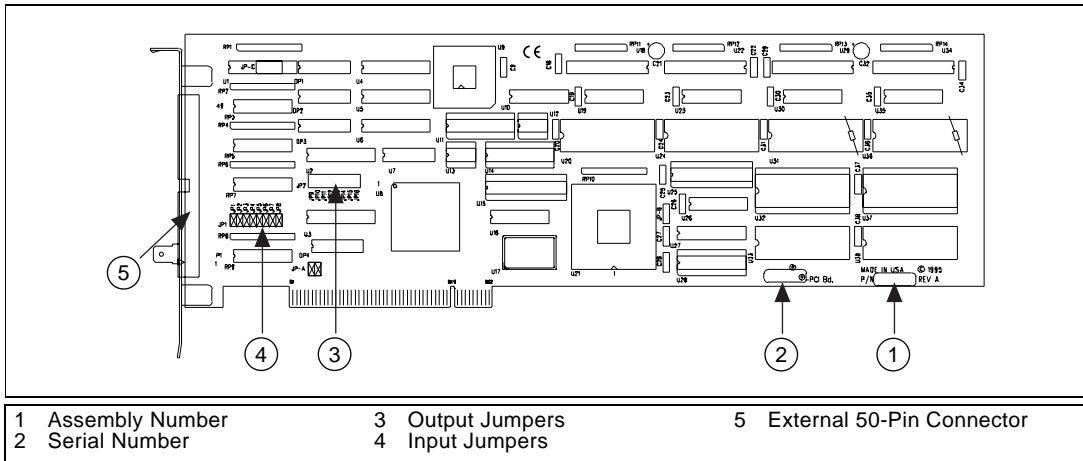

Figure 3-3. PCI-Servo Parts Locator Diagram

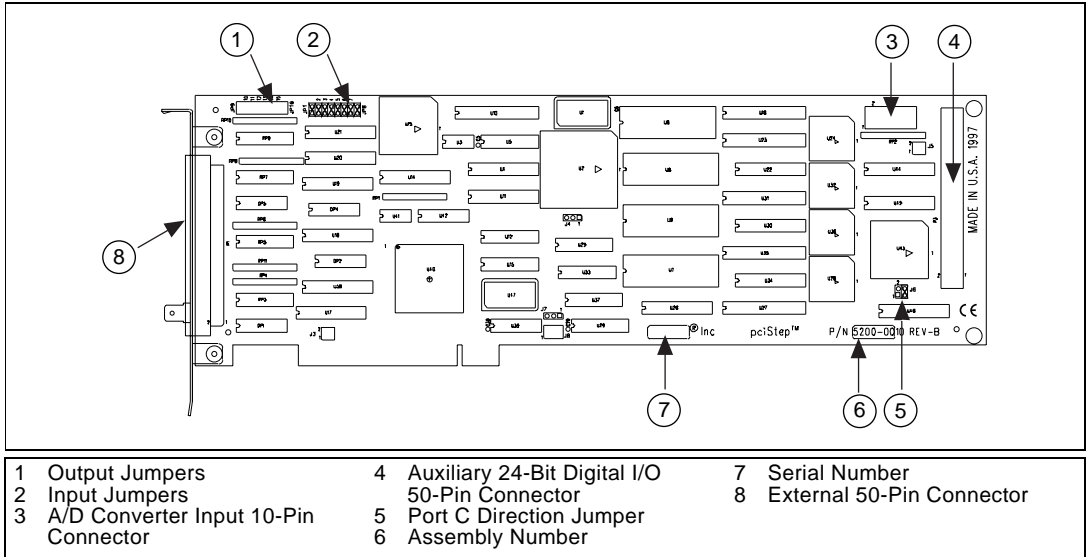

Figure 3-4. PCI-Step Parts Locator Diagram

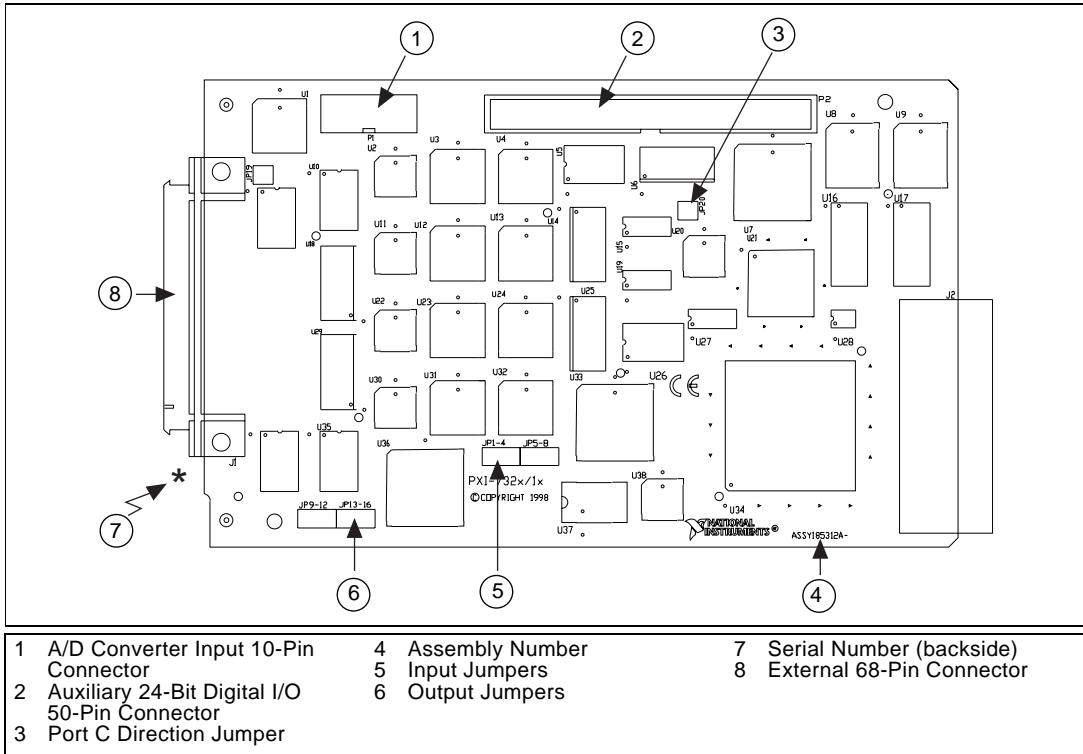

Figure 3-5. PXI-Step Parts Locator Diagram

Functional Modes

Trapezoidal Profile Position Control

The ValueMotion servo and stepper controllers implement trapezoidal profile control. They provide point-to-point motion based on the difference between the current position and the desired target position using preprogrammed acceleration and velocity values. The trapezoidal motion profile is calculated based on the move duration, maximum velocity, and desired acceleration. Motion occurs first with a programmable acceleration, then for a period at a constant velocity (if possible) and finally with a preprogrammed deceleration stopping or setting desired target position. You can interrupt motion by halt-stopping via a limit or home switch input or you can execute a stop or kill function. The stepper boards also have a programmable acceleration factor that boosts the acceleration at low speeds to match the inherent torque vs. speed characteristics of

stepper motor systems. Servo boards use proportional-integral-differential (PID) loop control with user-controlled gain parameters for optimum trajectory control.

Stepper and servo boards require parameter loading in conjunction with motion trajectory function-level programming. The open-loop stepper board parameters are expressed primarily in terms of steps, step count, and steps/second. Functions accessing closed-loop functions also use steps/revolution, encoder lines/revolution, and quadrature encoder counts. Servo boards use parameters expressed in quadrature encoder counts, counts per PID sample period velocity, and counts per PID sample period squared (acceleration). pcRunner, LabVIEW, and BridgeVIEW application software allow you to configure parameters in units including revolutions per minute (RPM) and revolutions per second per second (RPSPS).

Velocity Control

With the velocity control mode, you can continue motion at a preprogrammed velocity until a limit or home switch is encountered or until a stop or kill function is executed.

Velocity Profiling

With the velocity profiling mode, you can preprogram acceleration to a desired velocity that is maintained until a new velocity value is loaded. New velocity values may be loaded at any time. The system executes the most recent function and attains the new programmed velocity. Motion is continuous until a limit or home switch is encountered or until a stop or kill function is executed. This mode is useful for continuous contouring applications.



Note

Stepper boards do not use the acceleration value when changing to a new velocity, which can result in an abrupt motion for large velocity changes.

Event-Based Motion Profiling

ValueMotion boards offer the advanced feature of event-based motion profiling. Event-based motion profiling involves preloading motion control functions into onboard memory trigger buffers. This allows you to execute single or multiple move sequences using digital I/O trigger events. Triggers can be external I/O events or manual trigger functions sent by the host computer under function control. This mode can be used for semi-autonomous operation or for precise coordination with external events.

Electronic Gearing (Servo Only)

With electronic gearing you can slave one or more axes to a master axis for synchronous ratio based motion. The master axis operates identically to a normal axis, and supports all position and velocity based motions. A slave axis operates in a special mode that sets a target position based on a scale factor of the position of the master axis. For example, setting a scale factor of 3/2 results in the slave axis rotating three revolutions for every two revolutions of the master. You can configure each slave axis to have its own scale factor relative to the master axis.

Trajectory Parameters

All trajectory parameters used by the servo boards are expressed in terms of quadrature counts. Stepper board motion parameters are expressed in terms of steps or for closed-loop quadrature counts.

The boards obtain closed-loop position and velocity control by using an incremental quadrature encoder for feedback. All position data is referred to in quadrature counts. You can determine quadrature counts by multiplying the number of encoder lines per index period multiplied by four, as shown:

$$\text{Encoder Lines Per Index Period} \times 4$$

The encoder resolution is the number of encoder lines between consecutive encoder indexes (marker or Z-bit). If the encoder does not have an index output, the resolution is referred to as lines per revolution for rotary encoders and as lines per inch (or mm) for linear encoders.

Refer to the *ValueMotion Software Reference Manual* for specific information on loading trajectory parameters to your ValueMotion board.

Position Value Loading

- ◆ Servo and Closed-loop Stepper

Position is specified in quadrature counts as a signed number. The number of quadrature counts per revolution depends upon the incremental encoder used for feedback.

◆ Open-loop Stepper

For open-loop stepper boards, position is specified in step counts as a signed number. The number of step counts per revolution depends upon the type of stepper driver and motor being used. For example, a stepper motor with 1.8°/step (200 steps/revolution) used in conjunction with a x10 microstep driver would have an effective resolution of 2,000 steps per revolution. Stepper boards support all full-, half-, and microstep applications.

Velocity Value Loading

Velocity is expressed as change in position divided by time. For servo and closed-loop stepper boards, position is specified in quadrature counts. For open-loop stepper boards, position is specified in step counts. You can use the following formulas to convert revolutions per minute (RPM) to quadrature or step counts per second.

Quadrature counts per second:

$$\text{Velocity} = (\text{Velocity in RPM}) \times (\text{Encoder Lines}) \times (4) \times (1/60)$$

Step counts per second:

$$\text{Velocity} = (\text{Velocity in RPM}) \times (\text{Driver Steps/Motor Step}) \times (\text{Motor Steps/Rev}) \times (1/60).$$

The driver steps/motor step is determined by configuring the stepper driver. The driver steps/motor steps ratio is 1 for full step, 1/2 for half step, and 1/*n* for microstep where *n* is the microstep value.

Acceleration Value Loading

Acceleration is expressed as change in velocity divided by time, which is equivalent to change in position divided by time divided by time. For servo and closed-loop stepper boards, position is specified in quadrature counts. For open-loop stepper boards, position is specified in step counts. Use the following formulas to convert revolutions per second per second (RPSPS) to quadrature or step counts per second per second.

Quadrature counts per second per second:

$$\text{Acceleration} = (\text{Acceleration in RPSPS}) \times (\text{Encoder Lines}) \times (4)$$

Step counts per second per second:

$$\text{Acceleration} = (\text{Acceleration in RPSPS}) \times (\text{Driver Steps/Motor Step}) \times (\text{Motor steps/Rev})$$

The driver steps/motor step is determined by configuring the stepper driver. The driver steps/motor steps ratio is 1 for full step, 1/2 for half step, and 1/ n for microstep where n is the microstep value.







Address Table

Table 3-1 is a list of possible base addresses for the PC-Servo and PC-Step along with the corresponding settings for the address selector DIP switch. All addresses in this table are hexadecimal. Positions 1 through 6 are used for setting the base address. Position 8 is used for setting the direction of the port C auxiliary digital I/O. The factory-default base address for your board is 0x3E0.

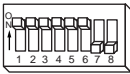
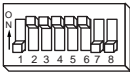
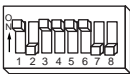
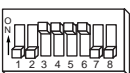
**Note**

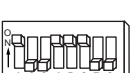
Certain addresses that are typically used for host computer functions such as serial and parallel I/O ports and display adaptors are indicated. However, since not all manufacturers follow these standards, verify that an address is not used before setting PC-Servo and PC-Step to that address.

Table 3-1. ISA Bus Address Map

Base Address	DIP Switch Address	Typical Use ¹
200		Game I/O
208		
210		
218		
220		
228		
230		
238		
240		
248		
250		













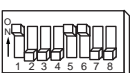



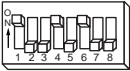
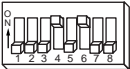

Base Address	DIP Switch Address	Typical Use ¹
258		
260		
268		
270		
278		Parallel Port 2
280		
288		
290		
298		
2A0		
2A8		

Table 3-1. ISA Bus Address Map (Continued)

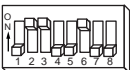
Base Address	DIP Switch Address	Typical Use ¹
2B0		
2B8		
2C0		
2C8		
2D0		
2D8		
2E0		
2E8		Serial Port 4
2F0		
2F8		Serial Port 2
300		Prototype Card

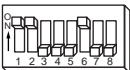
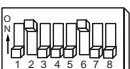









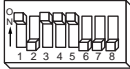

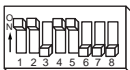
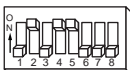
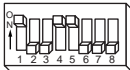
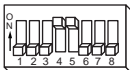
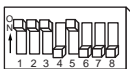
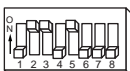

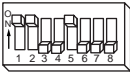
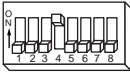
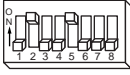
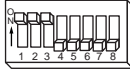
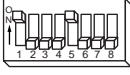
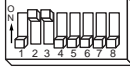
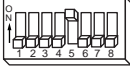
Base Address	DIP Switch Address	Typical Use ¹
308		Prototype Card
310		Prototype Card
318		Prototype Card
320		
328		
330		
338		
340		
348		
350		
358		

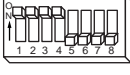
Table 3-1. ISA Bus Address Map (Continued)

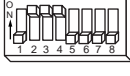
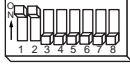
Base Address	DIP Switch Address	Typical Use ¹	Base Address	DIP Switch Address	Typical Use ¹
360		PC Network	3B8		Monochrome/ Printer
368		PC Network	3C0		EGA/VGA Adapter
370			3C8		EGA/VGA Adapter
378		Parallel Port 1	3D0		CGA/MCGA Adapter
380		SDLC/ Bisynchronous	3D8		CGA/MCGA Adapter
388		SDLC/ Bisynchronous	3E0		
390			3E8		Serial Port 3
398			3F0		Diskette Controller
3A0		Bisynchronous 1	3F8		Serial Port 1
3A8		Bisynchronous 1	¹ Blank table cells indicate this base address is typically available for plug-in boards.		
3B0		Monochrome/ Printer			

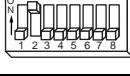
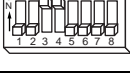
Signal Connections

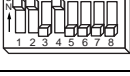
This chapter describes how to make input and output signal connections to the ValueMotion boards.

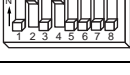
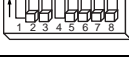
I/O Connector

Figure 4-1 shows the pin assignments for the 50-pin I/O connector on the PC and PCI servo boards. A signal description follows the connection pinouts.

Axis 1 Cmd-	1	2	Axis 1 Cmd+
Common	3	4	Axis 1 Encoder Ph A
Common	5	6	Axis 1 Encoder Ph B
Axis 1 Home Switch	7	8	Axis 1 Encoder Index
I/O 1	9	10	Axis 1 Forward Limit Switch
I/O 5	11	12	Axis 1 Reverse Limit Switch
Axis 2 Cmd-	13	14	Axis 2 Cmd+
Common	15	16	Axis 2 Encoder Ph A
Common	17	18	Axis 2 Encoder Ph B
Axis 2 Home Switch	19	20	Axis 2 Encoder Index
I/O 2	21	22	Axis 2 Forward Limit Switch
I/O 6	23	24	Axis 2 Reverse Limit Switch
Axis 3 Cmd-	25	26	Axis 3 Cmd+
Common	27	28	Axis 3 Encoder Ph A
Common	29	30	Axis 3 Encoder Ph B
Axis 3 Home Switch	31	32	Axis 3 Encoder Index
I/O 3	33	34	Axis 3 Forward Limit Switch
I/O 7	35	36	Axis 3 Reverse Limit Switch
Axis 4 Cmd-	37	38	Axis 4 Cmd+
Common	39	40	Axis 4 Encoder Ph A
Common	41	42	Axis 4 Encoder Ph B
Axis 4 Home Switch	43	44	Axis 4 Encoder Index
I/O 4	45	46	Axis 4 Forward Limit Switch
I/O 8	47	48	Axis 4 Reverse Limit Switch
Common	49	50	Host +5 V

Figure 4-1. 50-Pin Servo Connector Pin Assignment

Figure 4-2 shows the pin assignments for the 50-pin I/O connector on the PC and PCI stepper boards.

Axis 1 Dir/CCW	1	2	Axis 1 Step / CW
Common	3	4	Axis 1 Encoder Ph A
Common	5	6	Axis 1 Encoder Ph B
Axis 1 Home Switch	7	8	Axis 1 Encoder Index
I/O 1	9	10	Axis 1 Forward Limit Switch
Axis 1 Inhibit	11	12	Axis 1 Reverse Limit Switch
Axis 2 Dir/CCW	13	14	Axis 2 Step / CW
Common	15	16	Axis 2 Encoder Ph A
Common	17	18	Axis 2 Encoder Ph B
Axis 2 Home Switch	19	20	Axis 2 Encoder Index
I/O 2	21	22	Axis 2 Forward Limit Switch
Axis 2 Inhibit	23	24	Axis 2 Reverse Limit Switch
Axis 3 Dir/CCW	25	26	Axis 3 Step / CW
Common	27	28	Axis 3 Encoder Ph A
Common	29	30	Axis 3 Encoder Ph B
Axis 3 Home Switch	31	32	Axis 3 Encoder Index
I/O 3	33	34	Axis 3 Forward Limit Switch
Axis 3 Inhibit	35	36	Axis 3 Reverse Limit Switch
Axis 4 Dir/CCW	37	38	Axis 4 Step / CW
Common	39	40	Axis 4 Encoder Ph A
Common	41	42	Axis 4 Encoder Ph B
Axis 4 Home Switch	43	44	Axis 4 Encoder Index
I/O 4	45	46	Axis 4 Forward Limit Switch
Axis 4 Inhibit	47	48	Axis 4 Reverse Limit Switch
Common	49	50	Host +5 V

Figure 4-2. 50-Pin Stepper Connector Pin Assignment

Figure 4-3 shows the pin assignments for the 68-pin I/O connector on the PXI boards.

Axis 1 Dir/CCW	1	35	Axis 1 Step/CW
Common	2	36	Axis 1 Encoder Ph A
Common	3	37	Axis 1 Encoder Ph B
Axis 1 Home Switch	4	38	Axis 1 Encoder Index
I/O 1(input)	5	39	Axis 1 Forward Limit Switch
Axis 1 Inhibit	6	40	Axis 1 Reverse Limit Switch
Axis 2 Dir/CCW	7	41	Axis 2 Step/CW
Common	8	42	Axis 2 Encoder Ph A
Common	9	43	Axis 2 Encoder Ph B
Axis 2 Home Switch	10	44	Axis 2 Encoder Index
I/O 2 (input)	11	45	Axis 2 Forward Limit Switch
Axis 2 Inhibit	12	46	Axis 2 Reverse Limit Switch
Axis 3 Dir/CCW	13	47	Axis 3 Step/CW
Common	14	48	Axis 3 Encoder Ph A
Common	15	49	Axis 3 Encoder Ph B
Axis 3 Home Switch	16	50	Axis 3 Encoder Index
I/O 3 (input)	17	51	Axis 3 Forward Limit Switch
Axis 3 Inhibit	18	52	Axis 3 Reverse Limit Switch
Axis 4 Dir/CCW	19	53	Axis 4 Step/CW
Common	20	54	Axis 4 Encoder Ph A
Common	21	55	Axis 4 Encoder Ph B
Axis 4 Home Switch	22	56	Axis 4 Encoder Index
I/O 4 (input)	23	57	Axis 4 Forward Limit Switch
Axis 4 Inhibit	24	58	Axis 4 Reverse Limit Switch
Common	25	59	Host +5 V
I/O 1 (output)	26	60	I/O 2 (output)
I/O 3 (output)	27	61	I/O 4 (output)
Reserved	28	62	Reserved
Reserved	29	63	Reserved
Reserved	30	64	Reserved
Reserved	31	65	Reserved
A/D Channel 1	32	66	A/D Channel 2
A/D Channel 3	33	67	A/D Channel 4
+5 V	34	68	Reference Ground

Figure 4-3. 68-Pin PXI Stepper Pin Assignment

Table 4-1 describes the signals on the I/O connectors.

Table 4-1. Signal Descriptions for I/O Connector Pins

Signal Name	Reference	Direction	Description
Axis <1..4> Dir/CCW	Common	Output	Stepper only—motor direction or counter-clockwise control
Axis <1..4> Step/CW	Common	Output	Stepper only—motor step or clockwise control
Axis <1..4> Cmd-	—	—	Servo only—reference for cmd+
Axis <1..4> Cmd+	Axis <1..4> Cmd-	Output	Servo only—analog motor command
Axis <1..4> Encoder Phase A	Common	Input	Closed-loop only—phase A encoder input
Axis <1..4> Encoder Phase B	Common	Input	Closed-loop only—phase B encoder input
Axis <1..4> Home Switch	Common	Input	Home switch
Axis <1..4> Forward Limit Switch	Common	Input	Forward/clockwise limit switch
Axis <1..4> Reverse Limit Switch	Common	Input	Reverse/counter-clockwise limit switch
Axis <1..4> Inhibit	Common	Output	Stepper only—drive inhibit
I/O <1..8>	Common	Input/Output	I/O port bit <1..8>. Servo only—also 8-bit analog input
Host +5 V	Common	Output	+5 V— bus power interlock
Reference Ground	—	—	PXI Stepper only—reference for analog inputs
A/D Channel <1..4>	Reference Ground	Input	PXI Stepper only—8-bit analog input
+5 V	Reference Ground	Output	+5 V—analog reference level
Common	—	—	reference for digital I/O

External Connector Wiring Recommendations

The external connector may be broken up into five separate sections for the purpose of wiring descriptions. Four of the sections are identical in pinout, format, and connector configuration. Each of these four identical sections corresponds to an individual axis controller circuit. The fifth section is the bus power interlock section.

Each per-axis motion I/O connector sub section consists of four functional areas:

- Motor drive outputs
- Encoder feedback inputs
- Limit and home switch inputs
- Related motion I/O port bits



Caution *These four function groups must be wired separately from each other to prevent noise or signal crosstalk from affecting adjacent signal groups. Failure to take these simple precautions may cause faulty operation.*

It is important to note that numerous ground connections are provided in the ValueMotion I/O connector. Proper use of these ground connections will help to prevent unwanted signal disturbance and noise. Use these ground connections as ground current return paths or as shield connections for proper signal grounding applications.

Bus Power Signal

The bus power +5 V signal is available for bus monitoring and interlock purposes. It is not intended to power external circuitry or components. Current draw should not exceed 100 mA maximum.

I/O Port and Inhibit Signals

The following sections describe hardware jumper selection and the specifications for I/O port and inhibit signal interconnection. For correct operation, you must execute motion system set up including I/O port software initialization using the ValueMotion functions before you can use the I/O port and inhibit signals.



Caution *The I/O port bits <5..8> on the stepper boards are used as dedicated axis inhibit output signals. These signals cannot be used as inputs, and for proper operation must be jumper configured as outputs.*

Input Signals

Input signals to the I/O port may be active high or active low. Proper operation depends upon correct set up and programming of I/O polarity and direction. Improper set up and programming may cause faulty operation.

Output Signals

I/O Port signals configured as outputs are single-ended TTL with internally pulled-up open collector buffers. Pull-up resistors are 3.3 k Ω to +5 V. These buffers can sink 64 mA.

Wiring Concerns



Caution *Keep I/O port signals and I/O port grounds wired separately from the motor drive signals. Wiring these signals near each other can cause faulty operation. Be sure to use adequate ground signal connections in conjunction with I/O port bit signal connections.*

Jumper Configuration

Two hardware jumper locations are available for each I/O port bit on the ValueMotion board. One of these locations is for input signal configuration and the other is for output signal configuration. The jumpers are used in conjunction with I/O port configuration and polarity programming to properly set up the I/O port function. The jumpers must be properly installed and must correspond to the direction programmed to ensure correct operation of the I/O port bits.



Caution *Never install both input and output jumpers for the same I/O Port bit locations; for example, 1 and 9, 2 and 10, 3 and 11, etc.*

Table 4-2 shows the I/O Port bit assignments and the corresponding hardware jumpers.

Table 4-2. Jumper Pin I/O Port Bit Correspondence

I/O Port Bit Number	Input Jumper Number	Output Jumper Number
1	JP-1	JP-9
2	JP-2	JP-10
3	JP-3	JP-11
4	JP-4	JP-12
5	JP-5	JP-13
6	JP-6	JP-14

Table 4-2. Jumper Pin I/O Port Bit Correspondence (Continued)

I/O Port Bit Number	Input Jumper Number	Output Jumper Number
7	JP-7	JP-15
8	JP-8	JP-16

The ValueMotion boards have eight jumpers, all located on the input pins JP1 through JP8. Refer to Figures 3-1 through 3-5 in Chapter 3, *Hardware Overview*, for input/output jumper locations.

I/O Port Hardware Circuit

Figure 4-4 shows a simplified schematic diagram of the hardware circuitry used by the I/O ports for input signal buffering and output signal drive, as well as the jumper locations.

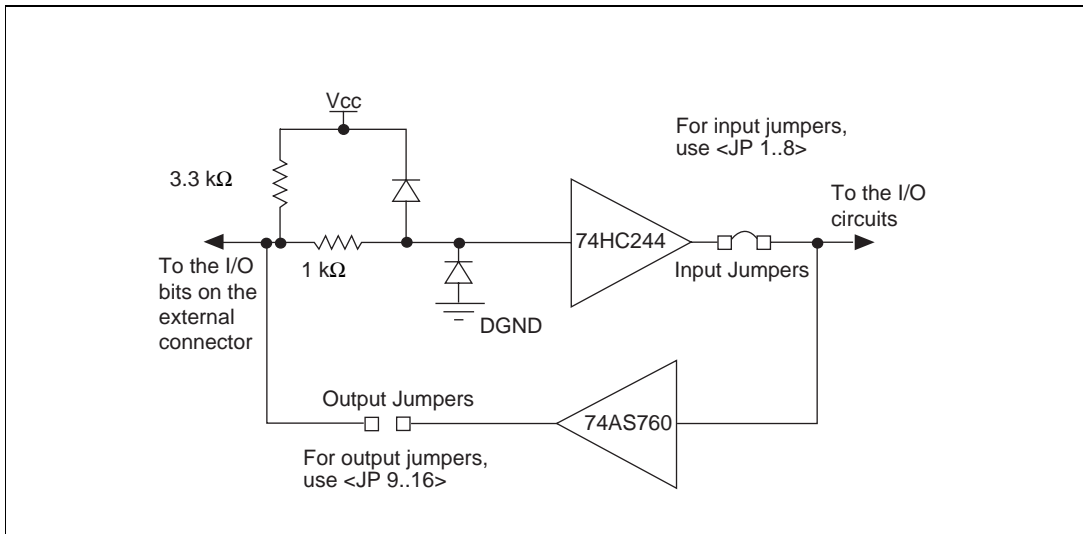

Figure 4-4. I/O Port Input and Output Hardware Circuitry

The board provides protection for input signal over-voltage and misconnection of the I/O port bits. However, you must take care when making these and any other hardware wiring connections. The inputs are clamped between 0 and 5 V through a 1 kΩ 1/4 W resistor. 12 V input signals can be interfaced directly but higher voltages should be avoided. With the 3.3 kΩ pull-up resistor, you directly interface to open collector signals.



Caution *Excessive input voltages may cause component failure.*

Limit and Home Switches

Limit and home switch inputs can be software configured as active high or active low enabled single-ended signals. Limit and home switch inputs may be enabled and disabled through software. Unused limit inputs may be directly used as nondedicated, general-purpose digital input channels.

An active input signal on an enabled limit or home switch input causes motion to immediately decelerate or halt stop on the corresponding axis. Limit and home switch input signals perform special motion control functions during the Find Home function.



Note *While limit switch transitions are edge-detected and stops motion, active inputs should remain active to prevent motion from proceeding further into the limit or in the limit direction. Pulsed signals cause motion to stop but they do not prevent further motion profiles that are restarted beyond an active limit position.*

Limit switch inputs are a per-axis, system-level enhancement on the ValueMotion boards and are not required for basic motion control. These inputs are part of a system solution for complete motion control. All motion control functions may be operated without limit switches except the Find Home function, which requires enabled limit inputs for operations.

Wiring Concerns



Caution *Keep limit and home switch signals and their ground connections wired separately from the motor driver/amplifier signal connections. Wiring these signals near each other can cause faulty operation.*

Limit and Home Switch Input Circuit

Figure 4-5 shows a simplified schematic diagram of the circuit configuration used by the limit and home switch inputs for input signal buffering and detection.

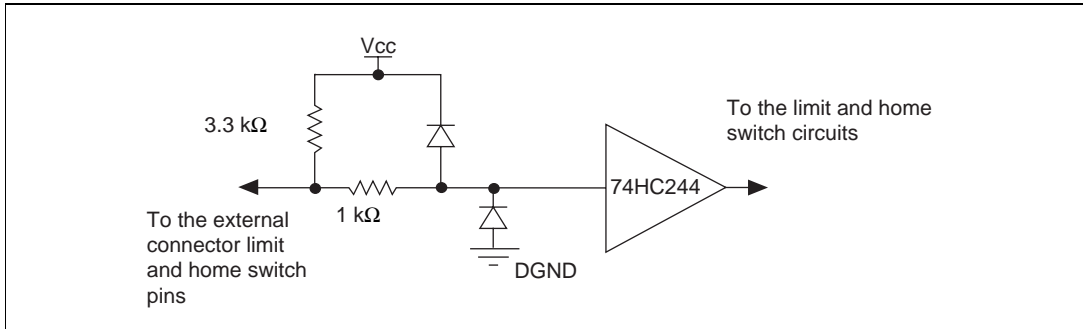

Figure 4-5. Limit Switch and Home Switch Input Hardware Circuitry

The board provides protection for over-voltage inputs on the limit and home switch input signal. However, take care when making these and any other hardware wiring connections. The inputs are clamped between 0 and 5 V through a 1 kΩ 1/4 W resistor. 12 V input signals can be interfaced directly but higher voltages must be avoided. The 3.3 kΩ pull-up resistor allows you to interface to open collector signals.



Caution *Excessive input voltages can cause erroneous operation and/or component failure.*

Encoder Connections (Closed-Loop Boards Only)

Encoder signal inputs can be single-ended TTL signals. Take care to observe the phasing of the Phase A and Phase B encoder quadrature signals to ensure that the direction of motor motion and encoder feedback signals are coincident and correctly related. For more information, see Figure 4-6.

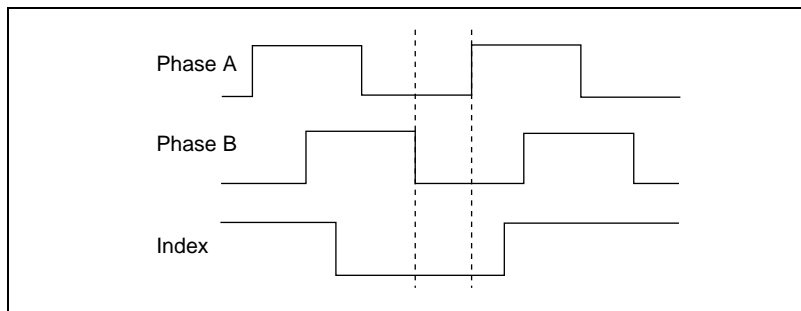

Figure 4-6. Quadrature Encoder Phasing Diagram

Wiring Concerns

The encoder inputs are connected to quadrature decoder/counter circuits. You must minimize noise at this interface. Excessive noise may overwhelm the digital filters on these input signals resulting in loss of counts or extra counts and erroneous closed-loop motion operation. Verify the encoder connections before powering up the system.



Caution *Wire encoder signals and their ground connections separately from the motor driver signal connections. Wiring these signals near each other causes mispositioning and faulty operation.*

Encoder Signals

ValueMotion boards expect quadrature encoder input feedback signals 90° out of phase from each other. Any deviation from this signal type, or excessive noise on the encoder signals causes faulty operation and lost quadrature counts.



Note *Determine quadrature counts by multiplying the encoder resolution in encoder lines by 4. The encoder resolution is the number of encoder lines between consecutive encoder indexes (marker or Z-bit). If the encoder does not have an index output, the resolution would be referred to as lines per revolution, or lines per unit of measure (in., cm, mm, etc.).*

Encoder Index Pulse Signal

You can use the ValueMotion boards with an active low index (marker or Z-bit) input. This signal must be single-ended, TTL compatible and properly phased in both polarity and sequence with respect to the Phase A and Phase B input signals. See Figure 4-6 for more information about the quadrature encoder phasing. The index state is defined when all three signals, Phase A, Phase B, and Index, are low. To avoid redundancy, the Index signal must be less than 360° of a full quadrature period. Improper index signal connection and configuration may cause faulty operation during the Find Index function. If this function is not functioning properly, check the encoder index signal connection, polarity, and sequence.

Encoder Signal Input Circuit

Figure 4-7 shows a simplified schematic diagram of the hardware circuit used by the encoder inputs for input signal buffering.

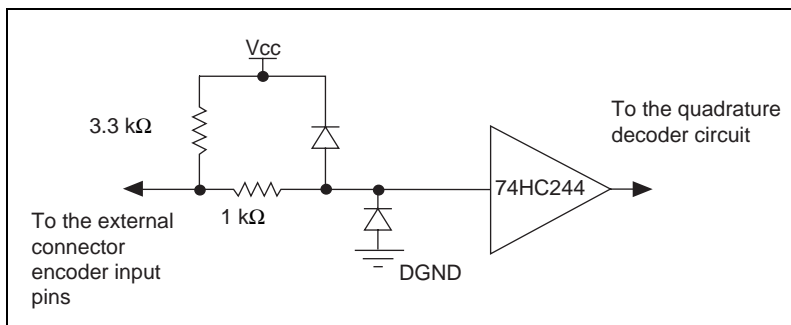

Figure 4-7. Encoder Feedback Input Hardware Circuitry

The board provides protection for over-voltage inputs and misconnection of the Encoder Input signals. However, take care when making these and any other hardware wiring connections. The inputs are clamped between 0 and 5 V through a 1 kΩ 1/4 W resistor. The 3.3 kΩ pull-up resistor allows you to connect to open collector signals.



Caution *Excessive input voltages can cause component failure.*

Auxiliary 24-Bit Digital I/O Connector (Stepper Only)

You can program the auxiliary 24-bit digital I/O port for digital I/O functionality. The 24-bit digital I/O port is configured in hardware as three 8-bit digital I/O ports. The three byte wide 8-bit ports are referred to as ports A, B, and C. The auxiliary 24-bit digital I/O is accessed from a 50-pin connector as shown in Figure 4-8.

Aux Digital I/O 24	1	2	Common
Aux Digital I/O 23	3	4	Common
Aux Digital I/O 22	5	6	Common
Aux Digital I/O 21	7	8	Common
Aux Digital I/O 20	9	10	Common
Aux Digital I/O 19	11	12	Common
Aux Digital I/O 18	13	14	Common
Aux Digital I/O 17	15	16	Common
Aux Digital I/O 16	17	18	Common
Aux Digital I/O 15	19	20	Common
Aux Digital I/O 14	21	22	Common
Aux Digital I/O 13	23	24	Common
Aux Digital I/O 12	25	26	Common
Aux Digital I/O 11	27	28	Common
Aux Digital I/O 10	29	30	Common
Aux Digital I/O 9	31	32	Common
Aux Digital I/O 8	33	34	Common
Aux Digital I/O 7	35	36	Common
Aux Digital I/O 6	37	38	Common
Aux Digital I/O 5	39	40	Common
Aux Digital I/O 4	41	42	Common
Aux Digital I/O 3	43	44	Common
Aux Digital I/O 2	45	46	Common
Aux Digital I/O 1	47	48	Common
+5 V	49	50	Common

Figure 4-8. Auxiliary 24-bit Digital I/O 50-Pin Connector

Port A consists of auxiliary digital I/O bits 1 through 8 available on the auxiliary 24-bit digital I/O connector. Always configure these bits as input bits only. Read data from the Port A bits, and the data will always reflect the actual input bit levels. Configure Port A for output bits and writing output data to Port A does nothing. For more information, see Figure 4-9.

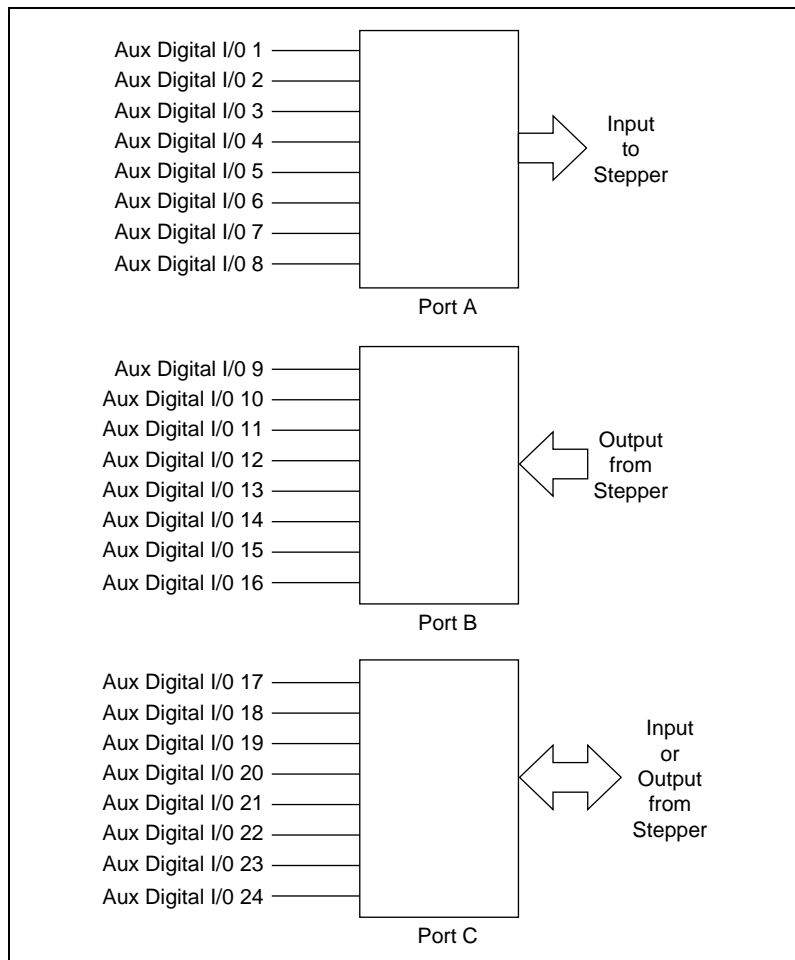

Figure 4-9. Auxiliary 24-Bit Digital I/O Port Configuration

Port B consists of digital I/O bits 9 through 16 available on the auxiliary 50-pin I/O connector. Always configure these bits as output bits only. Write data to the Port B bits, and the outputs reflect the actual output bit levels programmed. Port B can not be configured for input bits. Reading input data from Port B returns the desired data output values for the bits programmed. See Figure 4-9 for more information.

Readback of the Port B bit data can be very useful in programming these bits. By reading back the present output bit settings and then using logical binary functions, you can directly mask and set output data values for this port. If the output data is independent of the present value of output Port B,

it is also simple to write the new desired bit levels to the port directly overriding the previous values.

Port C consists of auxiliary digital I/O bits 17 through 24 available on the auxiliary 50-pin I/O connector. You can configure these bits byte wide as input or output bits. You can configure Port C direction as all output bits or all input bits by using two required configuration settings.

Complete the following steps to set the Port C direction:

1. **PC-Step (Only)**

Set the 8th position on the board address DIP switch as On or Off to select the hardware direction configuration of Port C I/O direction. Refer to Chapter 3, *Hardware Overview*, and Figure 4-10 for more information on setting the DIP switches.

PCI and PXI Step (Only)

Set the jumper (item 5 in Figure 3-4, *PCI-Step Parts Locator Diagram*, for PCI, item 3 in Figure 3-5, *PXI-Step Parts Locator Diagram*, for PXI) to input or output to select the hardware direction configuration of Port C I/O direction. Refer to Figure 4-11 for more information on jumper configuration.

2. Use the Set Aux. I/O Port Output function to set up the desired Port C direction of the Port C data byte. Refer to your *ValueMotion Software Reference Manual* for more information on function calling.

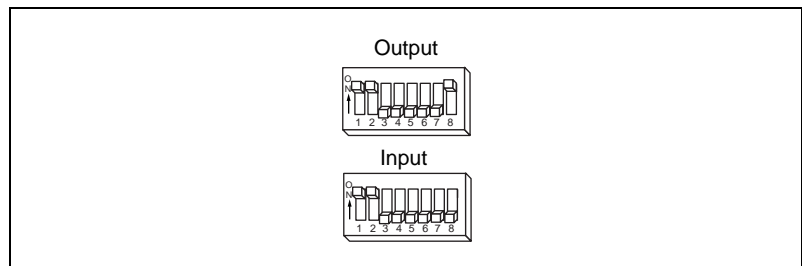

Figure 4-10. PC-Step Port C Direction Setting



Note

The base address selection shown is 0x3E0 and is for reference only; the Port C direction switch operates independently of the address selected.

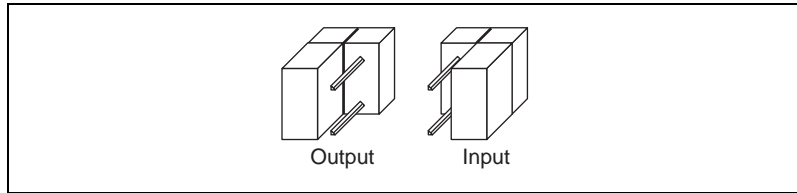

Figure 4-11. PCI- and PXI-Step Port C Direction Setting

Data may be written to the Port C bits when they are configured as output bits, and the outputs will reflect the desired output bit levels set. Configure Port C for input bits. Reading data from Port C returns the actual data input or user-programmed output values for the bits depending on Port C direction selected.

Readback of the Port C bit data can be very useful in programming these bits. By reading back the present output bit settings and then using logical binary functions, you can directly mask and set output data values for this port. If the output data is independent of the present value of the output Port C, it is also simple to write the new desired bit levels to the port directly.

ADC Inputs

The PC-Servo and all closed-loop stepper boards contain an eight channel ADC for basic analog input operations. The A/D channels on the stepper boards are accessed from a 10-pin connector as shown in Figure 4-12. You can also access the first four analog channels on the PXI stepper boards from the 68-pin motion connector. The A/D channels on the PC-Servo are accessed from the 50-pin connector, and map to the I/O port bits. There is a one-to-one mapping of the pins. For example, A/D Channel 1 is on I/O Port Bit 1, A/D Channel 2 is on I/O Port Bit 2, etc.

A/D Channel 1	1	2	A/D Channel 2
A/D Channel 3	3	4	A/D Channel 4
A/D Channel 5	5	6	A/D Channel 6
A/D Channel 7	7	8	A/D Channel 8
+5 V	9	10	Reference Ground

Figure 4-12. External Pin Assignment for the 10-Pin ADC Connector

ADC Overview

You can configure the eight channel ADC on the ValueMotion board for simple A/D conversion or motion integrated functionality. The ADC is a 0 and 5 V range 8-bit converter. You can use A/D input channels 1 through 8 independently as analog inputs.

You can read back the analog voltage input digital representation on any of the board's eight ADC channels by using the Read A/D Function. The values read back will be in the range of:

$$0 \leq \text{A/D Channel Number Readback Value} \leq 255$$

You can read any channel by indicating the desired channel number when using the A/D readback function.

Specifications

This appendix lists the specifications of your ValueMotion boards. These specifications are typical at 25° C unless otherwise noted.

Servo Performance

Absolute position range $\pm 2^{30}$ counts
Max relative move size $\pm 2^{30}$ counts
Max encoder frequency 750 kHz

Stepper Performance

Max step frequency 750,000 steps/s
Absolute position range $\pm 2^{31}$ steps
Max relative move size $\pm 2^{21}$ steps
Max encoder frequency 1 MHz

Motion Digital I/O

Input Circuits (Incl. Encoder Feedback, Limit Switches, and I/O Port Inputs)

Input voltage range 0 to 15 V
Input low voltage 0.8 V
Input high voltage 2 V

Output Circuits (Incl. Step, Direction, and I/O Port Outputs)

- Output voltage range 0 to 5 V
- Output low voltage < 0.6 V at 64 mA
- Output high voltage 3.3 k pull-up to
+5 V (open collector)

Auxiliary 24-Bit Digital I/O

- ◆ Stepper
 - Input voltage range 0 to 5 V
 - Input low voltage 0.8 V
 - Input high voltage 2 V
 - Output voltage range 0 to 5 V
 - Output low voltage < 0.5 V at 24 mA
 - Output high voltage > 2.4 V at 3 mA

Analog Output

- ◆ Servo
 - Output voltage range ± 10 V (typ)
 ± 9.5 V (min)
 - Output current ± 5 mA (typ)
 ± 40 mA (short-circuit)
 - Resolution 12 bits

Analog Input

- ◆ Closed-loop Stepper and PC-Servo
 - Input voltage range 0 to V_{cc} ($V_{cc} = +5$ V $\pm 3\%$)
 - Resolution 8 bits

Power Requirements (Max)

Device	+5 ($\pm 3\%$)	+12 V($\pm 3\%$)	-12 V ($\pm 3\%$)	Power Consumption
PC-Servo	1.5 A	0.1 A	0.15 A	10.5 W
PCI-Servo	1.5 A	0.1 A	0.15 A	10.5 W
PC-Step	1.2 A	0 A	0 A	6 W
PCI-Step	1.2 A	0 A	0 A	6 W
PXI-7324 PXI-7314	1.2 A	0 A	0 A	6 W

Physical

Dimensions (Not including connectors)

ISA 33.8 by 9.9 cm (13.3 by 3.9 in.)

PCI 31.2 by 9.9 cm (12.3 by 3.9 in.)

PXI 16 by 10 cm (6.3 by 3.9 in.)

Main I/O Connector

ISA and PCI 50-pin male box header

PXI 68-pin male SCSI-II type

A/D Connector

Closed-loop Stepper 10-pin male box header

Auxiliary 24-Bit Digital I/O Connector

Stepper 50-pin male box header

Environment

Operating temperature 0 to 70° C

Storage temperature -55 to 150° C

Relative humidity range 5 to 90% (noncondensing)

B

Cable Connector Descriptions

This appendix describes the connectors on the optional cables for your ValueMotion board.

Figures B-1 and B-2 show the pin assignments for the 50-pin motion connector. This connector is available when you use the NB1 or SH50-50 cable assembly with the PC and PCI boards, or when you use the SH68-68-S shielded cable assembly and the 68M-50F Step Bulkhead Cable Adapter with the PXI boards.

Axis 1 Cmd-	1	2	Axis 1 Cmd+
Common	3	4	Axis 1 Encoder Ph A
Common	5	6	Axis 1 Encoder Ph B
Axis 1 Home Switch	7	8	Axis 1 Encoder Index
I/O 1	9	10	Axis 1 Forward Limit Switch
I/O 5	11	12	Axis 1 Reverse Limit Switch
Axis 2 Cmd-	13	14	Axis 2 Cmd+
Common	15	16	Axis 2 Encoder Ph A
Common	17	18	Axis 2 Encoder Ph B
Axis 2 Home Switch	19	20	Axis 2 Encoder Index
I/O 2	21	22	Axis 2 Forward Limit Switch
I/O 6	23	24	Axis 2 Reverse Limit Switch
Axis 3 Cmd-	25	26	Axis 3 Cmd+
Common	27	28	Axis 3 Encoder Ph A
Common	29	30	Axis 3 Encoder Ph B
Axis 3 Home Switch	31	32	Axis 3 Encoder Index
I/O 3	33	34	Axis 3 Forward Limit Switch
I/O 7	35	36	Axis 3 Reverse Limit Switch
Axis 4 Cmd-	37	38	Axis 4 Cmd+
Common	39	40	Axis 4 Encoder Ph A
Common	41	42	Axis 4 Encoder Ph B
Axis 4 Home Switch	43	44	Axis 4 Encoder Index
I/O 4	45	46	Axis 4 Forward Limit Switch
I/O 8	47	48	Axis 4 Reverse Limit Switch
Common	49	50	Host +5 V

Figure B-1. 50-Pin Servo Connector Pin Assignment

Axis 1 Dir/CCW	1	2	Axis 1 Step / CW
Common	3	4	Axis 1 Encoder Ph A
Common	5	6	Axis 1 Encoder Ph B
Axis 1 Home Switch	7	8	Axis 1 Encoder Index
I/O 1	9	10	Axis 1 Forward Limit Switch
Axis 1 Inhibit	11	12	Axis 1 Reverse Limit Switch
Axis 2 Dir/CCW	13	14	Axis 2 Step / CW
Common	15	16	Axis 2 Encoder Ph A
Common	17	18	Axis 2 Encoder Ph B
Axis 2 Home Switch	19	20	Axis 2 Encoder Index
I/O 2	21	22	Axis 2 Forward Limit Switch
Axis 2 Inhibit	23	24	Axis 2 Reverse Limit Switch
Axis 3 Dir/CCW	25	26	Axis 3 Step / CW
Common	27	28	Axis 3 Encoder Ph A
Common	29	30	Axis 3 Encoder Ph B
Axis 3 Home Switch	31	32	Axis 3 Encoder Index
I/O 3	33	34	Axis 3 Forward Limit Switch
Axis 3 Inhibit	35	36	Axis 3 Reverse Limit Switch
Axis 4 Dir/CCW	37	38	Axis 4 Step / CW
Common	39	40	Axis 4 Encoder Ph A
Common	41	42	Axis 4 Encoder Ph B
Axis 4 Home Switch	43	44	Axis 4 Encoder Index
I/O 4	45	46	Axis 4 Forward Limit Switch
Axis 4 Inhibit	47	48	Axis 4 Reverse Limit Switch
Common	49	50	Host +5 V

Figure B-2. 50-Pin Stepper Connector Pin Assignment



Customer Communication

For your convenience, this appendix contains forms to help you gather the information necessary to help us solve your technical problems and a form you can use to comment on the product documentation. When you contact us, we need the information on the Technical Support Form and the configuration form, if your manual contains one, about your system configuration to answer your questions as quickly as possible.

National Instruments has technical assistance through electronic, fax, and telephone systems to quickly provide the information you need. Our electronic services include a bulletin board service, an FTP site, a fax-on-demand system, and e-mail support. If you have a hardware or software problem, first try the electronic support systems. If the information available on these systems does not answer your questions, we offer fax and telephone support through our technical support centers, which are staffed by applications engineers.

Electronic Services

Bulletin Board Support

National Instruments has BBS and FTP sites dedicated for 24-hour support with a collection of files and documents to answer most common customer questions. From these sites, you can also download the latest instrument drivers, updates, and example programs. For recorded instructions on how to use the bulletin board and FTP services and for BBS automated information, call 512 795 6990. You can access these services at:

United States: 512 794 5422

Up to 14,400 baud, 8 data bits, 1 stop bit, no parity

United Kingdom: 01635 551422

Up to 9,600 baud, 8 data bits, 1 stop bit, no parity

France: 01 48 65 15 59

Up to 9,600 baud, 8 data bits, 1 stop bit, no parity

FTP Support

To access our FTP site, log on to our Internet host, `ftp.natinst.com`, as anonymous and use your Internet address, such as `joesmith@anywhere.com`, as your password. The support files and documents are located in the `/support` directories.

Fax-on-Demand Support

Fax-on-Demand is a 24-hour information retrieval system containing a library of documents on a wide range of technical information. You can access Fax-on-Demand from a touch-tone telephone at 512 418 1111.

E-Mail Support (Currently USA Only)

You can submit technical support questions to the applications engineering team through e-mail at the Internet address listed below. Remember to include your name, address, and phone number so we can contact you with solutions and suggestions.

support@natinst.com

Telephone and Fax Support

National Instruments has branch offices all over the world. Use the list below to find the technical support number for your country. If there is no National Instruments office in your country, contact the source from which you purchased your software to obtain support.

Country	Telephone	Fax
Australia	03 9879 5166	03 9879 6277
Austria	0662 45 79 90 0	0662 45 79 90 19
Belgium	02 757 00 20	02 757 03 11
Brazil	011 288 3336	011 288 8528
Canada (Ontario)	905 785 0085	905 785 0086
Canada (Québec)	514 694 8521	514 694 4399
Denmark	45 76 26 00	45 76 26 02
Finland	09 725 725 11	09 725 725 55
France	01 48 14 24 24	01 48 14 24 14
Germany	089 741 31 30	089 714 60 35
Hong Kong	2645 3186	2686 8505
Israel	03 6120092	03 6120095
Italy	02 413091	02 41309215
Japan	03 5472 2970	03 5472 2977
Korea	02 596 7456	02 596 7455
Mexico	5 520 2635	5 520 3282
Netherlands	0348 433466	0348 430673
Norway	32 84 84 00	32 84 86 00
Singapore	2265886	2265887
Spain	91 640 0085	91 640 0533
Sweden	08 730 49 70	08 730 43 70
Switzerland	056 200 51 51	056 200 51 55
Taiwan	02 377 1200	02 737 4644
United Kingdom	01635 523545	01635 523154
United States	512 795 8248	512 794 5678

Technical Support Form

Photocopy this form and update it each time you make changes to your software or hardware, and use the completed copy of this form as a reference for your current configuration. Completing this form accurately before contacting National Instruments for technical support helps our applications engineers answer your questions more efficiently.

If you are using any National Instruments hardware or software products related to this problem, include the configuration forms from their user manuals. Include additional pages if necessary.

Name _____

Company _____

Address _____

Fax (____) _____ Phone (____) _____

Computer brand _____ Model _____ Processor _____

Operating system (include version number) _____

Clock speed _____ MHz RAM _____ MB Display adapter _____

Mouse ___ yes ___ no Other adapters installed _____

Hard disk capacity _____ MB Brand _____

Instruments used _____

National Instruments hardware product model _____ Revision _____

Configuration _____

National Instruments software product _____ Version _____

Configuration _____

The problem is: _____

List any error messages: _____

The following steps reproduce the problem: _____

ValueMotion Hardware and Software Configuration Form

Record the settings and revisions of your hardware and software on the line to the right of each item. Complete a new copy of this form each time you revise your software or hardware configuration, and use this form as a reference for your current configuration. Completing this form accurately before contacting National Instruments for technical support helps our applications engineers answer your questions more efficiently.

National Instruments Products

ValueMotion board _____

ValueMotion board serial number _____

Base memory address of the ValueMotion board _____

National Instruments application software choice _____

Software version _____

Other Products

Computer make and model _____

Microprocessor _____

Clock frequency or speed _____

Type of video board installed _____

Operating system (DOS or Windows) _____

Operating system mode _____

Programming language _____

Programming language version _____

Other boards in system _____

Base memory address of other boards _____

Interrupt level of other boards _____

Motor Driver/Amplifier Type and Manufacturer _____

Motor Type and Manufacturer _____

Connectivity Type (CB50, UMI, NuDrive, other) _____

Documentation Comment Form

National Instruments encourages you to comment on the documentation supplied with our products. This information helps us provide quality products to meet your needs.

Title: *ValueMotion Hardware User Manual*

Edition Date: May 1998

Part Number: 321940A-01

Please comment on the completeness, clarity, and organization of the manual.

If you find errors in the manual, please record the page numbers and describe the errors.

Thank you for your help.

Name _____

Title _____

Company _____

Address _____

E-Mail Address _____

Phone (____) _____ Fax (____) _____

Mail to: Technical Publications
National Instruments Corporation
6504 Bridge Point Parkway
Austin, Texas 78730-5039

Fax to: Technical Publications
National Instruments Corporation
512 794 5678

Glossary

Prefix	Meanings	Value
μ-	micro-	10^{-6}
m-	milli-	10^{-3}
c-	centi	10^{-2}
k-	kilo-	10^3
M-	mega-	10^6

Numbers/Symbols

°	degrees
%	percent
±	plus or minus
+	positive of, or plus
-	negative of, or minus
/	per
Ω	ohm
%	percent
+5 V	+5 VDC source signal

A

A	amperes
absolute mode	treat the target position loaded as position relative to zero while making a move
absolute position	signal position relative to zero

active high	a signal is active when its value goes high (1)
active low	a signal is active when its value goes low (0)
A/D	analog-to-digital
A/D Channel <1..4>	PXI Stepper—8-bit analog input
address	character code that identifies a specific location (or series of locations) in memory
amplifier	the drive that delivers power to operate the motor in response to low level control signals. In general, the amplifier is designed to operate with a particular motor type—you cannot use a stepper drive to operate a DC brush motor, for instance
anticipation time breakpoint	used to pre-load a desired anticipation time relative to the end of a programmed motion trajectory—when the position corresponding to the desired anticipation time is reached, an external breakpoint signal transitions on a dedicated I/O port output line for the selected axis. The anticipation breakpoint function is similar to, and shares the same resources as, the position breakpoint function.
API	application programming interface
axis	unit that controls a motor or any similar device
Axis <1..4> Cmd-	servo—axis 1 through 4 reference for cmd+
Axis <1..4> Cmd+	servo—axis 1 through 4 analog motor command
axis <1..4> Dir/CCW	stepper—axis 1 through 4 motor direction or counter-clockwise control
Axis <1..4> Encoder Phase A	closed-loop—axis 1 through 4 phase A encoder input
Axis <1..4> Encoder Phase B	closed-loop—axis 1 through 4 phase B encoder input
Axis <1..4> Forward Limit	axis 1 through 4 forward/clockwise limit switch
Axis <1..4> Home Switch	axis 1 through 4 home switch

Axis <1..4> Inhibit	stepper—axis 1 through 4 drive inhibit
Axis <1..4> Reverse Limit	axis 1 through 4 reverse/counter-clockwise limit switch
Axis <1..4> Step/CW	stepper—axis 1 through 4 motor step or clockwise control

B

b	bit—one binary digit, either 0 or 1
base address	memory address that serves as the starting address for programmable registers. All other addresses are located by adding to the base address.
binary	a number system with a base of 2
buffer	temporary storage for acquired or generated data (software)
bus	the group of conductors that interconnect individual circuitry in a computer. Typically, a bus is the expansion vehicle to which I/O or other devices are connected.
byte	eight related bits of data, an eight-bit binary number. Also used to denote the amount of memory required to store one byte of data.

C

CCW	counter-clockwise—implies direction of rotation of the motor
CL	closed-loop—A broadly applied term relating to any system where output is measured and compared to input. The output is then adjusted to reach the desired condition. In motion control this term applies to a system using an encoder or any feedback device.
common	reference signal for digital I/O
CPU	central processing unit
crosstalk	an unwanted signal on one channel due to an input on a different channel
CW	clockwise—implies direction of motor rotation

D

DC	direct current
dedicated	assigned to a particular function
DGND	digital ground signal
digital I/O port	a group of digital input/output signals
DIP	dual inline package
DLL	dynamic link library—provides the API for the motion control boards
drivers	software that controls a specific motion control board

E

encoder	device that translates mechanical motion into electrical signals; used for monitoring position or velocity
encoder resolution	the number of encoder lines between consecutive encoder indexes (marker or Z-bit). If the encoder does not have an index output the encoder resolution can be referred to as lines per revolution.

F

filtering	a type of signal conditioning that filters unwanted signals from the signal being measured
filter parameters	indicates the control loop parameter gains (PID gains) for a given axis
following error trip point	the difference between the instantaneous function trajectory position and the feedback position
freewheel	the condition of a motor when power is de-energized and the motor shaft is free to turn
full-step	full-step mode of a stepper motor—for a two phase motor this is done by energizing both windings or phases simultaneously

G

Gnd ground

GND ground

H

half-step mode of a stepper motor—for a two phase motor this is done by alternately energizing two windings and then only one. In half step mode, alternate steps are strong and weak but there is significant improvement in low-speed smoothness over the full-step mode.

hex hexadecimal

home switch (input) a reference position in a motion control system derived from a mechanical datum or switch. Often designated as the zero position.

host computer computer into which the motion control board is plugged

I

ID identification

in. inches

index marker between consecutive encoder revolutions

I/O input/output—the transfer of data to and from a computer system involving communications channels, operator interface devices, and/or motion control interfaces

I/O <1..8> servo—input/output port bits 1 through 8. Also 8-bit analog input.

interlock 5 volts bus interlock voltage

inverting the polarity of a switch (limit switch, home switch, etc.) in *active* state. If these switches are active-low they are said to have inverting polarity.

IRQ interrupt request

ISA industry standard architecture

K

k kilo—the standard metric prefix for 1,000, or 10^3 , used with units of measure such as volts, hertz, and meters

K kilo—the prefix for 1,024, or 2^{10} , used with B in quantifying data or computer memory

L

latching a signal that maintains its value while in a given state, as opposed to a signal that momentarily pulses when entering or exiting a state

limit switch (input) sensors that alert the control electronics that physical end of travel is being approached and that the motion should stop

M

m meters

microstep mode of a stepper motor—subdividing the basic motor step by proportioning the current in the windings. In this way the step size is reduced and low speed smoothness is dramatically improved

modulo position treat the target position as within the range of total quadrature counts per revolution for an axis

N

noise an undesirable electrical signal—noise comes from external sources such as the AC power line, motors, generators, transformers, fluorescent lights, soldering irons, CRT displays, computers, electrical storms, welders, radio transmitters, and internal sources such as semiconductors, resistors, and capacitors. Noise corrupts signals you are trying to send or receive.

noninverting the polarity of a switch (limit switch, home switch, etc.) in *active* state. If these switches are active-high, they are said to have non-inverting polarity.

O

OL open-loop—refers to a motion control system where no external sensors (feedback devices) are used to provide position or velocity correction signals

P

PID proportional-integral-derivative control loop

port (1) a communications connection on a computer or a remote controller
(2) a digital port, consisting eight lines of digital input and/or output

position breakpoint position breakpoint for an encoder can be set in absolute or relative quadrature counts. When the encoder reaches a position breakpoint, the associated breakpoint output immediately transitions.

power cycling turning the host computer off and then back on, which resets the motion control board

prestore trigger buffer function storage, which stores a series of functions in a buffer.

pull-in move when stepper motors are run in closed-loop mode, the encoder feedback is used to verify the position of an axis when the motion ends. The motion controller then functions the axis to do a final move so that it is at the desired target position.

PWM Pulse Width Modulation—a method of controlling the average current in a motors phase windings by varying the on-time (duty cycle) of transistor switches

Q

quadrature counts the encoder line resolution times four

R

RAM random-access memory

relative breakpoint sets the position breakpoint for an encoder in relative quadrature counts

relative mode	treat the target position loaded as position relative to current position while making a move
relative position	position relative to current position
ribbon cable	a flat cable in which the conductors are side by side
rotary axis	an axis for which rotary counts are loaded. The axis moves to the target position by taking the shortest path, either forward or backwards, while remaining within the one revolution defined by the loaded rotary counts.
RPM	revolutions per minute—units for velocity.
RPSPS or RPS/S	revolutions per second squared—units for acceleration and deceleration.

S

s	seconds
servo	specifies an axis that controls a servo motor
stepper	specifies an axis that controls a stepper motor

T

toggle	changing state from high to low, back to high, and so on
torque	force tending to produce rotation
trapezoidal profile	a typical motion trajectory, where a motor accelerates up to the programmed velocity using the programmed acceleration, traverses at the programmed velocity, then decelerates at the programmed acceleration to the target position
trigger	any event that causes or starts some form of data capture
TTL	transistor-transistor logic

V

V	volts
V _{CC}	positive voltage supply
velocity mode	move the axis continuously at the specified velocity

W

watchdog	a timer task that shuts down (resets) the motion control board if any serious error occurs
word	the standard number of bits that a processor or memory manipulates at one time, typically 8-, 16-, or 32-bit

Z

Z-bit	marker between consecutive encoder revolutions
-------	------------------------------------------------

Index

Numbers

- +5 V signal (table), 4-5
- 24-bit digital I/O connector. *See* auxiliary 24-bit digital I/O connector (stepper only).

A

- acceleration value loading, 3-7 to 3-8
- A/D Channel <1..4> signal (table), 4-5
- ADC inputs, 4-16 to 4-17
 - ADC overview, 4-17
 - external pin assignments (figure), 4-16
- address table, 3-8 to 3-11
- analog input specifications, A-2
- analog output specifications, A-2
- auxiliary 24-bit digital I/O connector (stepper only), 4-12 to 4-16
 - 50-pin connector (figure), 4-13
 - base address selection (note), 4-15
 - I/O port configuration (figure), 4-14
 - Port A, 4-13
 - Port B, 4-14 to 4-15
 - Port C direction setting, 4-15 to 4-16
 - specifications, A-2
- Axis<1..4> Cmd+ signal (table), 4-5
- Axis<1..4> Cmd- signal (table), 4-5
- Axis<1..4> Dir/CCW signal (table), 4-5
- Axis<1..4> Encoder Phase A signal (table), 4-5
- Axis<1..4> Encoder Phase B signal (table), 4-5
- Axis<1..4> Forward Limit Switch signal (table), 4-5
- Axis<1..4> Home Switch signal (table), 4-5
- Axis<1..4> Inhibit signal (table), 4-5
- Axis<1..4> Reverse Limit Switch signal (table), 4-5
- Axis<1..4> Step/CW signal (table), 4-5

B

- board configuration, 2-1 to 2-2
- BridgeVIEW software, 1-3
- bulletin board support, C-1

C

- Common (table), 4-5
- configuration, 2-1 to 2-2
- connectors
 - auxiliary 24-bit digital I/O connector (stepper only), 4-12 to 4-16
 - 50-pin connector (figure), 4-13
 - I/O port configuration (figure), 4-14
 - Port C direction setting, 4-15 to 4-16
 - external connector
 - bus power signal, 4-5 to 4-6
 - functional areas of per-axis motion I/O connector, 4-6
 - preventing noise or crosstalk (caution), 4-6
 - wiring recommendations, 4-5 to 4-6
 - I/O connector pin assignments, 4-1 to 4-4
 - 50-pin servo connector (figure), 4-2, B-1
 - 50-pin stepper connector (figure), 4-3, B-2
 - 68-pin PXI stepper connector (figure), 4-4
- customer communication, *xi*, C-1 to C-2

D

- digital I/O connector. *See* auxiliary 24-bit digital I/O connector (stepper only).

documentation

- about this manual, *ix*
- conventions used in manual, *x-xi*
- organization of manual, *ix-x*
- related documentation, *xi*

E

- electronic gearing (servo only), 3-6
- electronic support services, C-1 to C-2
- e-mail support, C-2
- encoder connections (closed-loop boards only), 4-10 to 4-12
 - determining quadrature counts (note), 4-11
 - encoder index pulse signal, 4-11
 - encoder signal input circuit, 4-12
 - encoder signals, 4-11
 - excessive input voltages (caution), 4-12
 - quadrature encoder phasing diagram, 4-10
 - wiring concerns, 4-11
- environment specifications, A-3
- equipment, optional, 1-3
- event-based motion profiling, 3-5
- external connector
 - bus power signal, 4-5 to 4-6
 - functional areas of per-axis motion I/O connector, 4-6
 - preventing noise or crosstalk (caution), 4-6
 - wiring recommendations, 4-5 to 4-6

F

- fax and telephone support numbers, C-2
- Fax-on-Demand support, C-2
- FTP support, C-1
- functional modes, 3-4 to 3-6
 - electronic gearing (servo only), 3-6
 - event-based motion profiling, 3-5

- trapezoidal profile position control, 3-4 to 3-5
- velocity control, 3-5
- velocity profiling, 3-5

H

- hardware installation, 2-2 to 2-3
- hardware overview, 3-1 to 3-11
 - address table, 3-8 to 3-11
 - functional modes, 3-4 to 3-6
 - electronic gearing (servo only), 3-6
 - event-based motion profiling, 3-5
 - trapezoidal profile position control, 3-4 to 3-5
 - velocity control, 3-5
 - velocity profiling, 3-5
 - parts locator diagrams
 - PCI-Servo, 3-2
 - PCI-Step, 3-3
 - PC-Servo, 3-1
 - PC-Step, 3-2
 - PXI-Step, 3-4
 - trajectory parameters, 3-6 to 3-8
 - acceleration value loading, 3-7 to 3-8
 - position value loading, 3-6 to 3-7
 - velocity value loading, 3-7
- home switches. *See* limit and home switches.
- Host +5 V signal (table), 4-5

I

- inhibit signals. *See* I/O port and inhibit signals.
- installation
 - hardware, 2-2 to 2-3
 - software, 2-1
- I/O <1..8> signal (table), 4-5
- I/O connector pin assignments, 4-1 to 4-4
 - 50-pin servo connector (figure), 4-2, B-1
 - 50-pin stepper connector (figure), 4-3, B-2

68-pin PXI stepper connector (figure), 4-4

I/O port and inhibit signals, 4-6 to 4-8

- dedicated axis inhibit output signals (caution), 4-6
- excessive input voltages (caution), 4-9
- input signals, 4-6
- I/O port hardware circuit, 4-8
- jumper configuration, 4-7 to 4-8
- output signals, 4-7
- wiring concerns, 4-7

ISA bus address map, 3-8 to 3-11

J

jumper configuration, I/O ports, 4-7 to 4-8

L

LabVIEW software, 1-3

LabWindows/CVI software, 1-3

limit and home switches, 4-9 to 4-10

- excessive input voltages (caution), 4-10
- input circuit, 4-9 to 4-10
- input hardware circuitry (figure), 4-10
- wiring concerns (caution), 4-9

M

manual. *See* documentation.

motion digital I/O specifications, A-1 to A-2

- input circuits, A-1
- output circuits, A-2

N

National Instruments application software, 1-3

O

optional equipment, 1-3

P

parts locator diagrams

- PCI-Servo, 3-2
- PCI-Step, 3-3
- PC-Servo, 3-1
- PC-Step, 3-2
- PXI-Step, 3-4

physical specifications, A-3

ports. *See also* I/O port and inhibit signals.

- Port A, 4-13
- Port B, 4-14 to 4-15
- Port C direction setting, 4-15 to 4-16
- PCI- and PXI-step (figure), 4-16
- PC-step (figure), 4-15

position value loading, 3-6 to 3-7

power requirement specifications, A-3

profiling

- event-based motion profiling, 3-5
- velocity profiling, 3-5

R

Reference Ground (table), 4-5

requirements for getting started, 1-1 to 1-2

S

servo performance specifications, A-1

signal connections, 4-1 to 4-17

- ADC inputs, 4-16 to 4-17
- ADC overview, 4-17
- external pin assignments (figure), 4-16

auxiliary 24-bit digital I/O connector (stepper only), 4-12 to 4-16

- 50-pin connector (figure), 4-13
- I/O port configuration (figure), 4-14
- Port C direction setting, 4-15 to 4-16

encoder connections (closed-loop boards only), 4-10 to 4-12

- encoder index pulse signal, 4-11

- encoder signal input circuit, 4-12
 - encoder signals, 4-11
 - quadrature encoder phasing diagram, 4-10
 - wiring concerns, 4-11
 - external connector wiring
 - recommendations, 4-5 to 4-6
 - bus power signal, 4-5 to 4-6
 - I/O connector pin assignments, 4-1 to 4-4
 - 50-pin servo connector (figure), 4-2, B-1
 - 50-pin stepper connector (figure), 4-3, B-2
 - 68-pin PXI stepper connector (figure), 4-4
 - I/O port and inhibit signals, 4-6 to 4-8
 - input signals, 4-6
 - I/O port hardware circuit, 4-8
 - jumper configuration, 4-7 to 4-8
 - output signals, 4-7
 - wiring concerns, 4-7
 - limit and home switches, 4-9 to 4-10
 - input circuit, 4-9 to 4-10
 - wiring concerns, 4-9
 - signal descriptions (table), 4-5
 - software
 - installation, 2-1
 - National Instruments software, 1-3
 - programming choices, 1-2
 - specifications, A-1 to A-3
 - analog input, A-2
 - analog output, A-2
 - auxiliary 24-bit digital I/O, A-2
 - environment, A-3
 - motion digital I/O, A-1 to A-2
 - input circuits, A-1
 - output circuits, A-2
 - physical, A-3
 - power requirements, A-3
 - servo performance, A-1
 - stepper performance, A-1
 - stepper performance specifications, A-1
- ## T
- technical support, C-1 to C-2
 - telephone and fax support numbers, C-2
 - trajectory parameters, 3-6 to 3-8
 - acceleration value loading, 3-7 to 3-8
 - position value loading, 3-6 to 3-7
 - velocity value loading, 3-7
 - trapezoidal profile position control, 3-4 to 3-5
- ## V
- ValueMotion boards. *See also* hardware overview.
 - connectors, 1-4
 - National Instruments application software, 1-3
 - optional equipment, 1-3
 - overview, 1-1
 - requirements for getting started, 1-1 to 1-2
 - software programming choices, 1-2
 - ValueMotion software, 1-2
 - ValueMotion VI Library, 1-3
 - velocity control, 3-5
 - velocity profiling, 3-5
 - velocity value loading, 3-7