



National Instruments USB-7845R Manual
Get Pricing & Availability at
ApexWaves.com

Call Today: 1-800-915-6216
Email: sales@apexwaves.com

<https://www.apexwaves.com/modular-systems/national-instruments/r-series/USB-7845R>

NI USB-7845R

R Series for USB Multifunction RIO with Kintex-7 70T FPGA

Français	Deutsch	日本語	한국어	简体中文
ni.com/manuals				

This document provides compliance, pinout, connectivity, mounting, and power information for the National Instruments USB-7845R.

Safety Guidelines



Caution Do not operate the NI USB-7845R in a manner not specified in this user manual. Product misuse can result in a hazard. You can compromise the safety protection built into the product if the product is damaged in any way. If the product is damaged, return it to National Instruments for repair.

Electromagnetic Compatibility Guidelines

This product was tested and complies with the regulatory requirements and limits for electromagnetic compatibility (EMC) as stated in the product specifications. These requirements and limits are designed to provide reasonable protection against harmful interference when the product is operated in its intended operational electromagnetic environment.

This product is intended for use in residential, commercial, and industrial locations. However, harmful interference may occur in some installations or when the product is connected to a peripheral device or a test object. To minimize interference with radio and television reception and prevent unacceptable performance degradation, install and use this product in strict accordance with the instructions in the product documentation.

Furthermore, any changes or modifications to the product not expressly approved by National Instruments could void your authority to operate it under your local regulatory rules.



Caution To ensure the specified EMC performance, operate this product only with shielded cables and accessories.



Caution To ensure the specified EMC performance, you must install the included snap-on ferrite bead onto the DC power cord of the power supply as described in the getting started guide.

Hardware Overview

The following high-level block diagram represents the NI USB-7845R.

Figure 1. NI USB-7845R Block Diagram

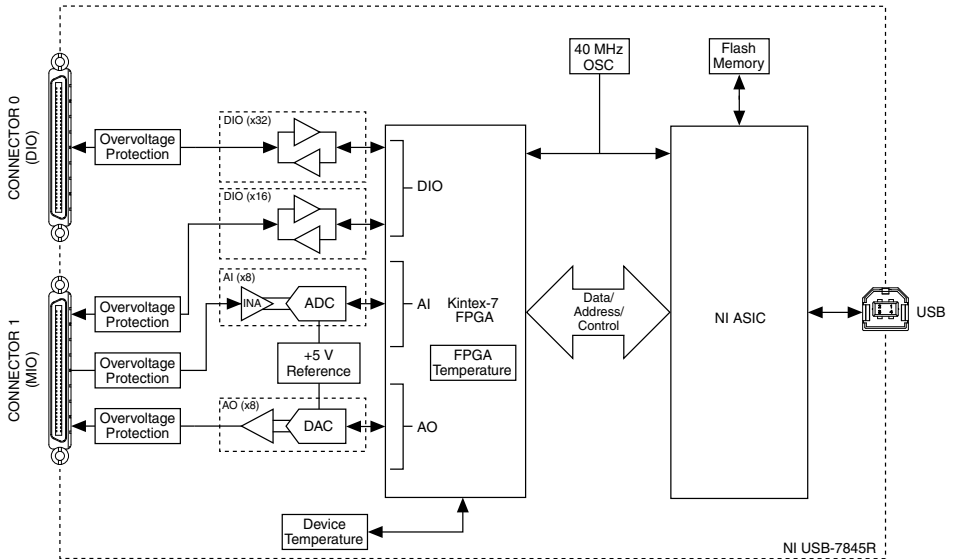

Connecting the NI USB-7845R

The NI USB-7845R provides connections for eight analog input (AI) channels, eight analog output (AO) channels, and forty-eight digital input/output (DIO) channels, as shown in Figure 2.

Figure 2. NI USB-7845R Pinout

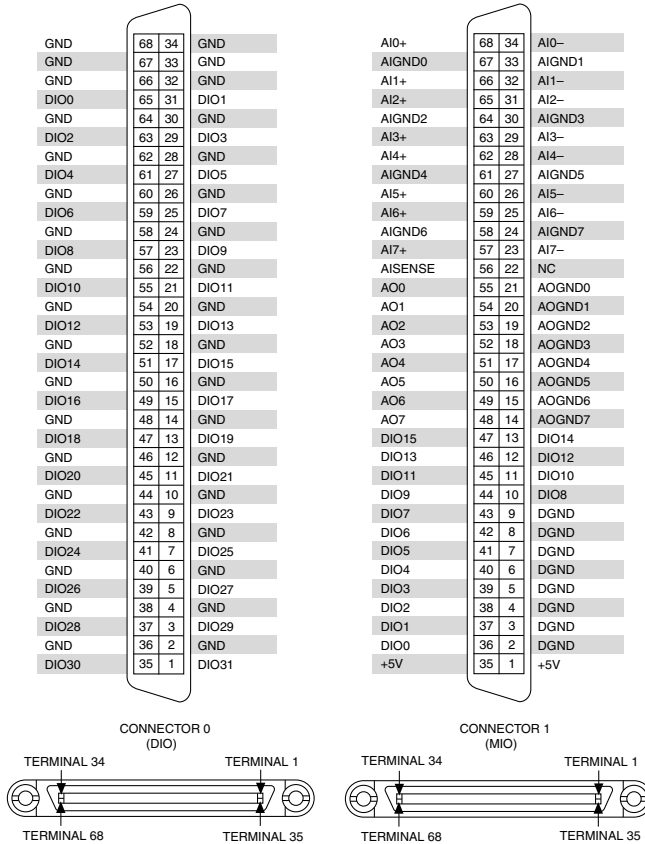

Connectivity Options

Use the following connection accessories and cables to access the signals on the I/O connectors.

Table 1. Connection Accessories and Cables

Connector Type	Accessory	Accessory Description	Cable	Cable Description
MIO	NI SCB-68A (782536-01)	A 68-pin, shielded I/O connector block	NI SHC68-68-RMIO (189588-01, 1 meter) or (189588-02, 2 meter)	A shielded, 68-conductor cable
DIO	NI SCB-68 HSDIO (782914-01)	A 68-pin, shielded high-speed digital connector block	NI SHC68-C68-RDIO2 (156166-01, 1 meter) or (156166-02, 2 meter)	A shielded, digital I/O 68-conductor cable

Analog Input

The NI USB-7845R provides connections for eight AI channels. Each channel has an AI+ pin, AI- pin, and AIGND pin to which you can connect both single-ended or differential voltage signals. Use the AISENSE pin to connect non-referenced single-ended signals.

Connecting Single-Ended Voltage Signals

To connect referenced single-ended voltage signals to the NI USB-7845R, you must connect the voltage ground signal to AI GND in order to keep the common-mode voltage in the specified range, as shown in Figure 3.

Figure 3. Connecting Referenced Single-Ended Signals to the NI USB-7845R

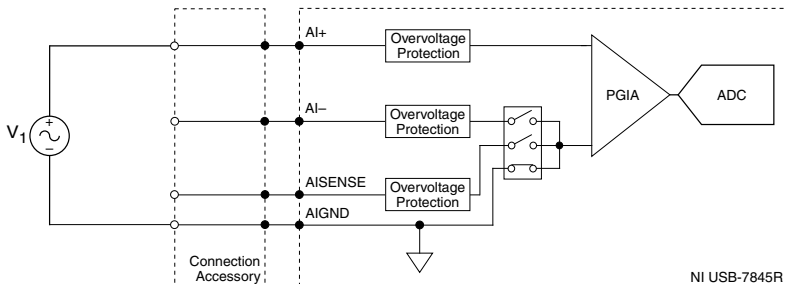

To connect non-referenced single-ended voltage signals to the NI USB-7845R, you must connect the voltage ground signal to AI SENSE in order to keep the common-mode voltage in the specified range, as shown in Figure 4.

Figure 4. Connecting Non-Referenced Single-Ended Signals to the NI USB-7845R

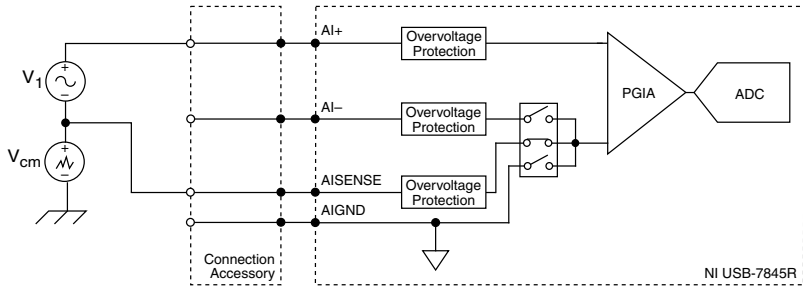

Connecting Differential Voltage Signals

You can connect grounded or floating differential signal sources to the NI USB-7845R. Connect the positive voltage signal to the AI+ and the negative voltage signal to AI-. To connect grounded differential signals to the NI USB-7845R, you must also connect the signal reference to AI GND.

Figure 5. Connecting Grounded Differential Signals to the NI USB-7845R

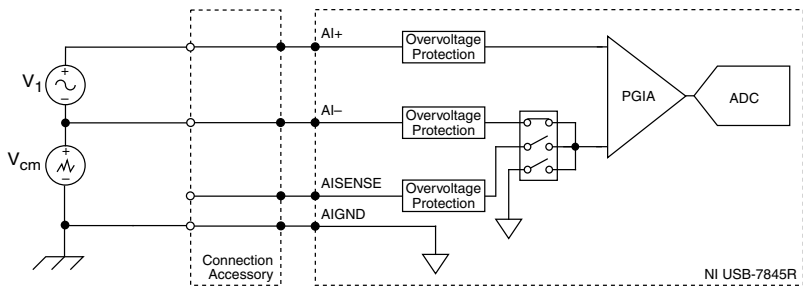

To connect floating differential signals to the NI USB-7845R, you must connect the negative and positive signals to AI GND through 1 M Ω resistors to keep the voltage within the common-mode voltage range. If the voltage source is outside the common-mode voltage range, the NI USB-7845R does not read data accurately.

Figure 6. Connecting Floating Differential Signals to the NI USB-7845R

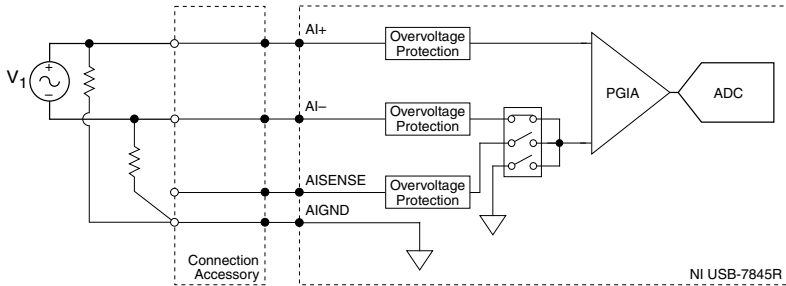

Analog Output

The NI USB-7845R provides connections for eight analog output channels. Each channel has an AO pin and AOGND pin to which you can connect a load.

Figure 7. Connecting a Load

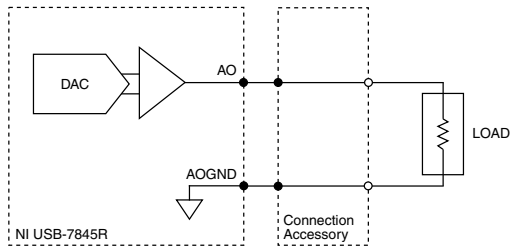

Digital I/O

The NI USB-7845R provides connections for 48 digital input/output (DIO) channels. Connector 0 contains 32 high-speed DIO channels that can run up to 80 MHz signal frequencies and Connector 1 contains 16 low-speed channels that can run up to 10 MHz signal frequencies. Each connector has selectable logic levels that you can configure as 1.2 V, 1.5 V, 1.8 V, 2.5 V, or 3.3 V. You can configure each channel as input or output.

Figure 8. Connecting to the DIO Channels

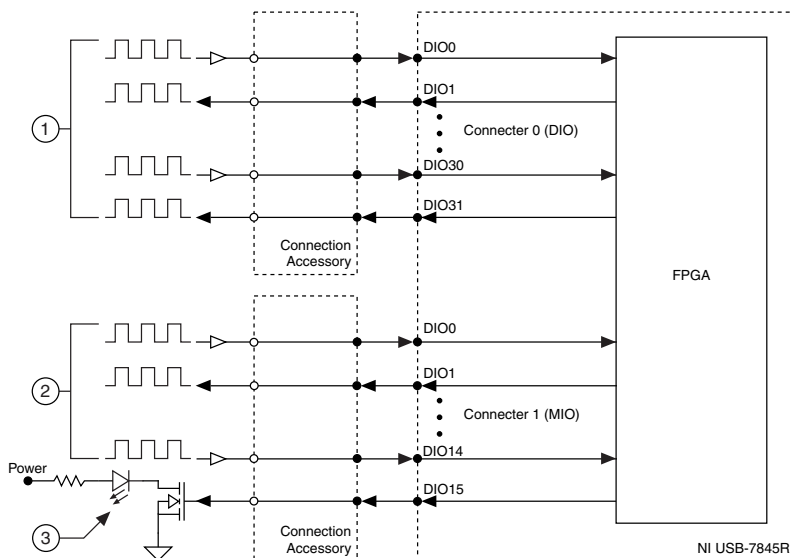

1. High-speed signal frequencies up to 80 MHz with logic levels configured as 1.2 V, 1.5 V, 1.8 V, 2.5 V, or 3.3 V.
2. Low-speed signal frequencies up to 10 MHz with logic levels configured as 1.2 V, 1.5 V, 1.8 V, 2.5 V, or 3.3 V.
3. LED

The DIO channels connect to the FPGA through buffers, which have overvoltage and undervoltage protection as well as over current protection. Refer to the *NI USB-7845R Specifications* for more information about the maximum voltage and current.

When the system powers on, the DIO channels are set as input low with pull-down resistors. To set another power-on state, you can configure the NI USB-7845R to load a VI when the system powers on. The VI can then set the DIO lines to any power-on state.

All the high-speed DIO channels on Connector 0 are routed with a 50 Ω characteristic trace impedance. Route all external circuitry with a similar impedance to ensure best signal quality. NI recommends performing signal integrity measurements to test the affect of signal routing with the cable and connection accessory for your application.

Field Wiring Considerations

Environmental noise can seriously affect the measurement accuracy of the device if you do not take proper care when running signal wire between signal sources and the device. The following recommendations mainly apply to AI signal routing to the device, as well as signal routing in general.

Take the following precautions to minimize noise pickup and maximize measurement accuracy:

- Use differential AI connections to reject common-mode noise.
- Use individually shielded, twisted-pair wires to connect AI signals to the device. With this type of wire, the signal attached to the positive and negative inputs are twisted together and then covered with a shield. You then connect this shield only at one point to the signal source ground. This kind of connection is required for signals traveling through areas with large magnetic fields or high electromagnetic interference.
- Route signals to the device carefully. Keep cabling away from noise sources, such as video monitors and analog signals.

Use the following recommendations for all signal connections to the NI USB-7845R:

- Separate NI USB-7845R signal lines from high-current or high-voltage lines. These lines can induce currents in or voltages on the NI USB-7845R signal lines if they run in parallel paths at a close distance. To reduce the magnetic coupling between lines, separate them by a reasonable distance if they run in parallel or run the lines at right angles to each other.
- Do not run signal lines through conduits that also contain power lines.
- Protect signal lines from magnetic fields caused by electric motors, welding equipment, breakers, or transformers by running them through special metal conduits.

Mounting R Series USB Devices

You can use your R Series USB device on a desktop, mount it on a wall, or mount it on a DIN rail.

Panel or Wall Mounting

Complete the following steps to panel or wall mount your NI USB-7845R. You can purchase the panel mounting kit at ni.com with part number 781514-01.

1. Use three #8-32 flathead screw to attach the backpanel wall mount to the panel or wall. Tighten the screw with a #2 Phillips screwdrivers to a torque of 1.1 N · m (10 lb · in.).
2. Place the NI USB-7845R on the backpanel wall mount with the signal wires facing down and the device bottom sitting on the backpanel wall mount lip.
3. While holding the NI USB-7845R in place, attach the front bracket to the backpanel wall mount by tightening the two thumbscrews.

Figure 9. Wall or Panel Mounting the NI USB-7845R

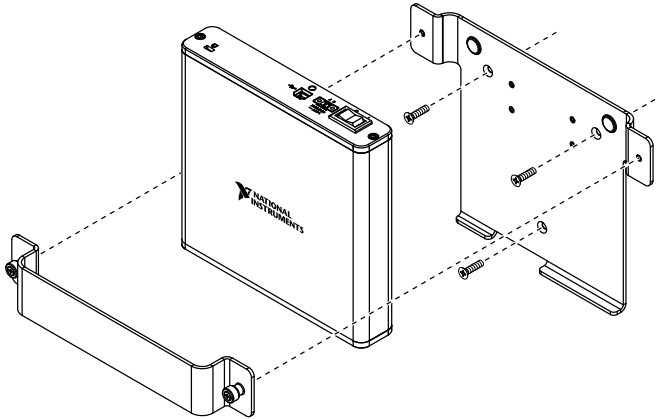

DIN Rail Mounting

Complete the following steps to mount your NI USB-7845R. You can purchase a DIN rail mounting clip at ni.com with part number 781515-01.

1. Fasten the DIN rail clip to the back of the backpanel wall mount using a #1 Phillips screwdriver and four machine screws. Tighten the screws to a torque of $0.4 \text{ N} \cdot \text{m}$ ($3.6 \text{ lb} \cdot \text{in.}$).
2. Clip the bracket onto the DIN rail as shown.

Figure 10. DIN Rail Clip Parts Locator Diagram

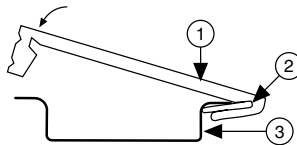

1. DIN Rail Clip
2. DIN Rail Spring
3. DIN Rail

3. Place the NI USB-7845R on the backpanel wall mount with the signal wires facing down and the device bottom sitting on the backpanel wall mount lip.
4. While holding the NI USB-7845R in place, attach the front bracket to the backpanel wall mount by tightening the two thumbscrews.



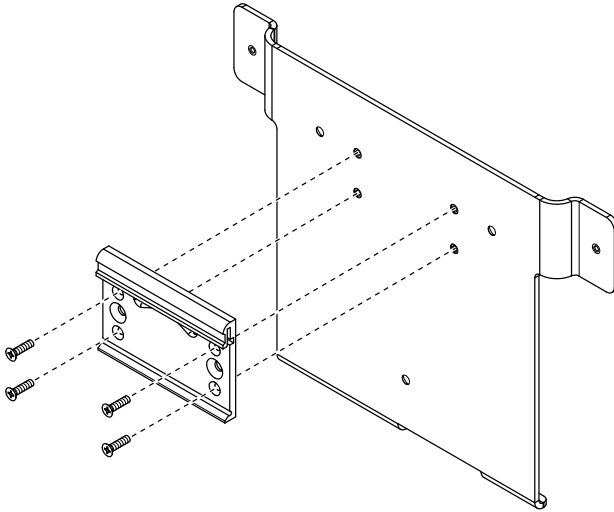
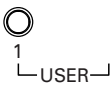
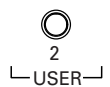

Figure 11. Attaching the DIN Rail Clip to the Backpanel Wall Mount



LEDs

The NI USB-7845R has six LEDs that reflect the device state.

Table 2. LED Descriptions

Symbol	LED	Description
	POWER	Solid blue when the power is on
	USB READY	Solid blue when the USB is ready
	ERROR	Solid red for error cases
	USER1	Blue, user-defined
	USER2	Blue, user-defined
	USER3	Blue, user-defined

The following figure shows the LEDs on the front panel of the NI USB-7845R.

Figure 12. NI USB-7845R Front Panel

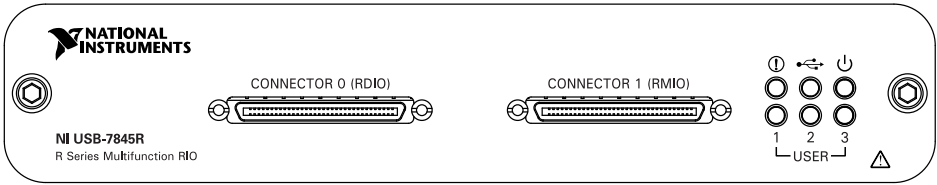

+5 V Power Source

Use the +5 V terminals on the I/O connector supply +5 V referenced to DGND to power external circuitry.



Caution Never connect the +5 V power terminals to analog or digital ground or any other voltage source on the NI USB-7845R or any other device. Doing so can damage the device and the computer. National Instruments is not liable for damage resulting from such a connection.

The power rating is 4.75 to 5.1 VDC at 0.5 A.

Autonomous Mode

You can run the NI USB-7845R without a USB connection to a host computer using Autonomous Mode. To collect data the NI USB-7845R acquires in Autonomous Mode, you must reconnect the NI USB-7845R to a host computer.



Caution Data is lost and is not recoverable upon reconnection if a DMA FIFO overflows while the NI USB-7845R is disconnected from the host computer or if the NI USB-7845R loses power at any point.

Autonomous Mode includes the following capabilities.

Table 3. Autonomous Mode Capabilities

Capability	Description
Use the Open/Close FPGA Reference VI functions to run an FPGA VI and then disconnect the USB cable.	Call the Close FPGA VI Reference Function without aborting or resetting the FPGA VI before you disconnect the USB cable. ¹ After you disconnect the USB cable, any VI running on the NI USB-7845R continues to run and collect data, which can later be retrieved by reconnecting the USB cable and re-opening the original FPGA reference.
Use Interactive Front Panel Communication to run an FPGA VI and then disconnecting the USB cable.	The front panel indicators stop updating. After you disconnect the USB cable, any VI running on the NI USB-7845R continues to run. Restore the Interactive Front Panel Communication by reconnecting the USB cable.
Download the bitfile to flash memory and set it to run when loaded to FPGA.	Download the bitfile to flash memory and set it to run when loaded to FPGA. The bitfile automatically starts running whenever power is applied to the NI USB-7845R. To collect data, you must reconnect the NI USB-7845R to a host computer before powering off the device. Refer to the <i>LabVIEW FPGA Module Help</i> for more information about downloading an FPGA VI to the flash memory.

Worldwide Support and Services

The National Instruments website is your complete resource for technical support. At ni.com/support, you have access to everything from troubleshooting and application development self-help resources to email and phone assistance from NI Application Engineers.

Visit ni.com/services for NI Factory Installation Services, repairs, extended warranty, and other services.

Visit ni.com/register to register your National Instruments product. Product registration facilitates technical support and ensures that you receive important information updates from NI.

National Instruments corporate headquarters is located at 11500 North Mopac Expressway, Austin, Texas, 78759-3504. National Instruments also has offices located around the world. For telephone support in the United States, create your service request at ni.com/support or dial 1 866 ASK MYNI (275 6964). For telephone support outside the United States, visit the

¹ The Host VI errors out if you do not call the Close FPGA VI Reference Function without aborting or resetting the FPGA VI.

Worldwide Offices section of ni.com/niglobal to access the branch office websites, which provide up-to-date contact information, support phone numbers, email addresses, and current events.

Refer to the *NI Trademarks and Logo Guidelines* at ni.com/trademarks for information on National Instruments trademarks. Other product and company names mentioned herein are trademarks or trade names of their respective companies. For patents covering National Instruments products/technology, refer to the appropriate location: **Help»Patents** in your software, the `patents.txt` file on your media, or the *National Instruments Patent Notice* at ni.com/patents. You can find information about end-user license agreements (EULAs) and third-party legal notices in the readme file for your NI product. Refer to the *Export Compliance Information* at ni.com/legal/export-compliance for the National Instruments global trade compliance policy and how to obtain relevant HTS codes, ECCNs, and other import/export data.

© 2014 National Instruments. All rights reserved.

374505A-01 Mar14